

# HYUNDAI



## ***OWNER'S MANUAL***

Operation  
Maintenance  
Specifications

تلفن شبانه روزی: ۰۲۱-۸۸۸۶۲۰۸۵

All information in this Owner's Manual is current at the time of publication. However, Hyundai reserves the right to make changes at any time so that our policy of continual product improvement may be carried out.

This manual applies to all models of this vehicle and includes descriptions and explanations of optional as well as standard equipment. As a result, you may find material in this manual that does not apply to your specific vehicle.

Please note that some models are equipped with Right-Hand Drive (RHD). The explanations and illustrations for some operations in RHD models are opposite of those written in this manual.

### CAUTION: MODIFICATIONS TO YOUR HYUNDAI

Your Hyundai should not be modified in any way. Such modifications may adversely affect the performance, safety or durability of your Hyundai and may, in addition, violate conditions of the limited warranties covering the vehicle. Certain modifications may also be in violation of regulations established by the Department of Transportation and other government agencies in your country.

تلفن شبانه روزی: ۰۲۱-۸۸۸۶۲۰۸۵

### TWO-WAY RADIO OR CELLULAR TELEPHONE INSTALLATION

Your vehicle is equipped with electronic fuel injection and other electronic components. It is possible for an improperly installed/adjusted two-way radio or cellular telephone to adversely affect electronic systems. For this reason, we recommend that you carefully follow the radio manufacturer's instructions or consult your Hyundai dealer for precautionary measures or special instructions if you choose to install one of these devices.

## SAFETY AND VEHICLE DAMAGE WARNING

This manual includes information titled as WARNING, CAUTION and NOTICE.

These titles indicate the following:

### **WARNING**

**This indicates that a condition may result in harm, serious injury or death to you or other persons if the warning is not heeded. Follow the advice provided with the warning.**

### **CAUTION**

***This indicates that a condition may result in damage to your vehicle or its equipment if the caution is not heeded. Follow the advice provided with the caution.***

### **\* NOTICE**

**This indicates that interesting or helpful information is being provided.**

تلفن شبانه روزی: ۰۲۱-۸۸۸۶۲۰۸۵  
FarmaSOS.com

## FOREWORD

Thank you for choosing Hyundai. We are pleased to welcome you to the growing number of discriminating people who drive Hyundais. The advanced engineering and high-quality construction of each Hyundai we build is something of which we're very proud.

Your Owner's Manual will introduce you to the features and operation of your new Hyundai. It is suggested that you read it carefully because the information it contains can contribute greatly to the satisfaction you receive from your new car.

The manufacturer also recommends that service and maintenance on your vehicle be performed by an authorized Hyundai dealer.

HYUNDAI MOTOR COMPANY

**Note** : Because future owners will also need the information included in this manual, if you sell this Hyundai, please leave the manual in the vehicle for their use. Thank you.

### CAUTION

***Severe engine and transaxle damage may result from the use of poor quality fuels and lubricants that do not meet Hyundai specifications. You must always use high quality fuels and lubricants that meet the specifications listed on Page 8-6 in the Vehicle Specifications section of the Owner's Manual.***

Copyright 2014 Hyundai Motor Company. All rights reserved. No part of this publication may be reproduced, stored in any retrieval system or transmitted in any form or by any means without the prior written permission of Hyundai Motor Company.

## ***TABLE OF CONTENTS***

Introduction

**1**

Your vehicle at a glance

**2**

Safety features of your vehicle

**3**

Features of your vehicle

**4**

Driving your vehicle

**5**

What to do in an emergency

**6**

Maintenance

**7**

Specifications & Consumer information

**8**

Index

**I**

# Introduction

How to use this manual ..... 1-2  
Fuel requirements ..... 1-3  
• Gasoline engine ..... 1-3  
• Diesel engine ..... 1-5  
Vehicle break-in process ..... 1-7  
Vehicle handling instructions ..... 1-7

امداد خودرو فارما

تلفن شبانه روزی: ۰۲۱-۸۸۸۶۲۰۸۵

FarmaSOS.com

### HOW TO USE THIS MANUAL

We want to help you get the greatest possible driving pleasure from your vehicle. Your Owner's Manual can assist you in many ways. We strongly recommend that you read the entire manual. In order to minimize the chance of death or injury, you must read the WARNING and CAUTION sections in the manual.

Illustrations complement the words in this manual to best explain how to enjoy your vehicle. By reading your manual, you will learn about features, important safety information, and driving tips under various road conditions.

The general layout of the manual is provided in the Table of Contents. Use the index when looking for a specific area or subject; it has an alphabetical listing of all information in your manual.

**Sections:** This manual has eight sections plus an index. Each section begins with a brief list of contents so you can tell at a glance if that section has the information you want.

You will find various WARNINGS, CAUTIONS, and NOTICES in this manual. These were prepared to enhance your personal safety. You should carefully read and follow ALL procedures and recommendations provided in these WARNINGS, CAUTIONS and NOTICES.

#### **WARNING**

**A WARNING indicates a situation in which harm, serious bodily injury or death could result if the warning is ignored.**

#### **CAUTION**

**A CAUTION indicates a situation in which damage to your vehicle could result if the caution is ignored.**

#### **\* NOTICE**

**A NOTICE indicates interesting or helpful information is being provided.**

## FUEL REQUIREMENTS

### Gasoline engine

#### Unleaded

##### For Europe

For the optimal vehicle performance, we recommend you to use unleaded gasoline which complies with EN 228 and has an octane rating of RON (Research Octane Number) 95 / AKI (Anti Knock Index) 91 or higher. You may use unleaded gasoline with an octane rating of RON 91-94 / AKI 87-90 but it may result in slight performance reduction of the vehicle.

##### Except Europe

Your new vehicle is designed to use only unleaded fuel having an Octane Rating of RON (Research Octane Number) 91 / AKI (Anti-Knock Index) 87 or higher.

Your new vehicle is designed to obtain maximum performance with UNLEADED FUEL, as well as minimize exhaust emissions and spark fouling.

#### CAUTION

**NEVER USE LEADED FUEL. The use of leaded fuel is detrimental to the catalytic converter and will damage the engine control system's oxygen sensor and affect emission control.**

**Never add any fuel system cleaning agents to the fuel tank other than what has been specified (We recommend that you consult an authorized HYUNDAI dealer for details.)**

#### WARNING

- Do not "top off" after the nozzle automatically shuts off when refueling.
- Always check that the fuel cap is installed securely to prevent fuel spillage in the event of an accident.

#### *Leaded (if equipped)*

For some countries, your vehicle is designed to use leaded gasoline. When you are going to use leaded gasoline, we recommend that you ask an authorized HYUNDAI dealer whether leaded gasoline in your vehicle is available or not.

Octane Rating of leaded gasoline is same with unleaded one.



### ***Gasoline containing alcohol and methanol***

Gasohol, a mixture of gasoline and ethanol (also known as grain alcohol), and gasoline or gasohol containing methanol (also known as wood alcohol) are being marketed along with or instead of leaded or unleaded gasoline.

Do not use gasohol containing more than 10% ethanol, and do not use gasoline or gasohol containing any methanol. Either of these fuels may cause drivability problems and damage to the fuel system.

Discontinue using gasohol of any kind if drivability problems occur.

Vehicle damage or driveability problems may not be covered by the manufacturer's warranty if they result from the use of:

1. Gasohol containing more than 10% ethanol.
2. Gasoline or gasohol containing methanol.
3. Leaded fuel or leaded gasohol.

### **CAUTION**

***Never use gasohol which contains methanol. Discontinue use of any gasohol product which impairs drivability.***

امداد خودرو فارما

تلفن شبانه روزی: ۰۲۱-۸۸۸۶۲۰۸۵

FarmaSOS.com

### ***Use of MTBE***

HYUNDAI recommends avoiding fuels containing MTBE (Methyl Tertiary Butyl Ether) over 15.0% vol. (Oxygen Content 2.7% weight) in your vehicle.

Fuel containing MTBE over 15.0% vol. (Oxygen Content 2.7% weight) may reduce vehicle performance and produce vapor lock or hard starting.

### **CAUTION**

***Your New Vehicle Limited Warranty may not cover damage to the fuel system and any performance problems that are caused by the use of fuels containing methanol or fuels containing MTBE (Methyl Tertiary Butyl Ether) over 15.0% vol. (Oxygen Content 2.7% weight.)***

**Do not use methanol**

Fuels containing methanol (wood alcohol) should not be used in your vehicle. This type of fuel can reduce vehicle performance and damage components of the fuel system.

**Fuel Additives**

HYUNDAI recommends that you use good quality gasolines meet Europe Fuel standards (EN228) or equivalents.

For customers who do not use good quality gasolines including fuel additives regularly, and have problems starting or the engine does not run smoothly, one bottle of additives added to the fuel tank at every 15,000km (for Europe)/ 5,000km (except Europe). Additives are available from your authorized HYUNDAI dealer along with information on how to use them. Do not mix other additives.

**Operation in foreign countries**

If you are going to drive your vehicle in another country, be sure to:

- Observe all regulations regarding registration and insurance.
- Determine that acceptable fuel is available.

امداد خودرو فارما

تلفن شبانه روزی: ۰۲۱-۸۸۸۶۲۰۸۵

FarmaSOS.com

**Diesel engine****Diesel fuel**

Diesel engine must be operated only on commercially available diesel fuel that complies with EN 590 or comparable standard. (EN stands for "European Norm"). Do not use marine diesel fuel, heating oils, or non-approved fuel additives, as this will increase wear and cause damage to the engine and fuel system. The use of non-approved fuels and / or fuel additives will result in a limitation of your warranty rights.

Diesel fuel of above cetane 51 is used in your vehicle. If two types of diesel fuel are available, use summer or winter fuel properly according to the following temperature conditions.

- Above -5°C (23°F) ... Summer type diesel fuel.
- Below -5°C (23°F) ... Winter type diesel fuel.

Watch the fuel level in the tank very carefully : If the engine stops through fuel failure, the circuits must be completely purged to permit restarting.

**⚠ CAUTION**

***Do not let any gasoline or water enter the tank. This would make it necessary to drain it out and to bleed the lines to avoid jamming the injection pump and damaging the engine.***

**⚠ CAUTION - Diesel Fuel (if equipped with DPF)**

***It is recommended to use the regulated automotive diesel fuel for diesel vehicle equipped with the DPF system.***

***If you use diesel fuel including high sulfur (more than 50 ppm sulfur) and unspecified additives, it can cause the DPF system to be damaged and white smoke can be emitted.***

***Biodiesel***

Commercially supplied Diesel blends of no more than 7% biodiesel, commonly known as "B7 Diesel" may be used in your vehicle if Biodiesel meets EN 14214 or equivalent specifications. (EN stands for "European Norm"). The use of biofuels exceeding 7% made from rapeseed methyl ester (RME), fatty acid methyl ester (FAME), vegetable oil methyl ester (VME) etc. or mixing diesel exceeding 7% with biodiesel will cause increased wear or damage to the engine and fuel system. Repair or replacement of worn or damaged components due to the use of non approved fuels will not be covered by the manufactures warranty.

FarmaSOS.com

**⚠ CAUTION**

- Never use any fuel, whether diesel, B7 biodiesel or otherwise, that fails to meet the latest petroleum industry specification.***
- Never use any fuel additives or treatments that are not recommended or approved by the vehicle manufacturer.***

## VEHICLE BREAK-IN PROCESS

No special break-in period is needed. By following a few simple precautions for the first 1,000 km (600 miles) you may add to the performance, economy and life of your vehicle.

- Do not race the engine.
- While driving, keep your engine speed (rpm, or revolutions per minute) between 2,000 rpm and 4,000 rpm.
- Do not maintain a single speed for long periods of time, either fast or slow. Varying engine speed is needed to properly break-in the engine.
- Avoid hard stops, except in emergencies, to allow the brakes to seat properly.
- Don't tow a trailer during the first 2,000 km (1,200 miles) of operation.

## VEHICLE HANDLING INSTRUCTIONS

As with other vehicles of this type, failure to operate this vehicle correctly may result in loss of control, an accident or vehicle rollover.

Specific design characteristics (higher ground clearance, track, etc.) give this vehicle a higher center of gravity than other types of vehicles. In other words they are not designed for cornering at the same speeds as conventional 2-wheel drive vehicles. Avoid sharp turns or abrupt maneuvers. Again, failure to operate this vehicle correctly may result in loss of control, an accident or vehicle rollover. **Be sure to read the "Reducing the risk of a rollover" driving guidelines, in section 5 of this manual.**

## Your vehicle at a glance

Exterior overview .....	2-2
Interior overview (I).....	2-4
Interior overview (II).....	2-6
Instrument panel overview .....	2-8
Engine compartment .....	2-10

امداد خودرو فارما

تلفن شبانه روزی: ۰۲۱-۸۸۸۶۲۰۸۵

FarmaSOS.com

## EXTERIOR OVERVIEW

■ Front view

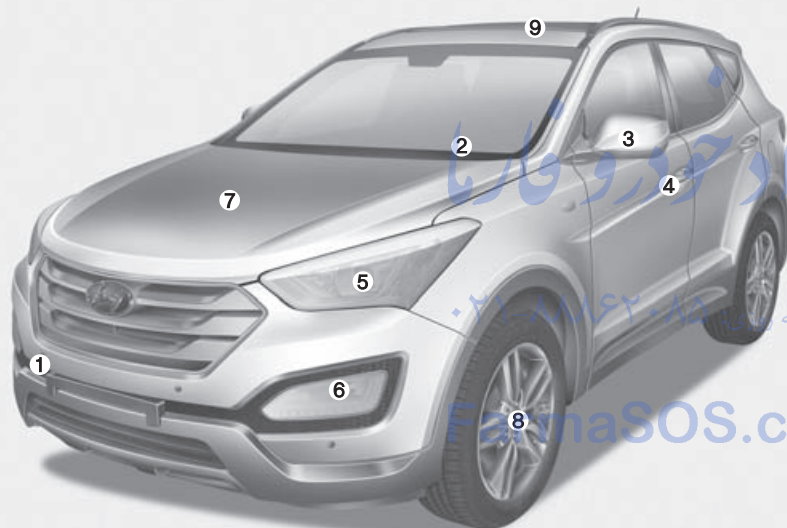

- 1. Towing hook..... 6-32
- 2. Front windshield wiper blades .....7-52
- 3. Outside rearview mirror .....4-54
- 4. Door locks.....4-19
- 5. Headlamp .....7-88
- 6. Front fog light.....4-127
- 7. Hood .....4-32
- 8. Tires and wheels .....7-58, 8-4
- 9. Panorama sunroof .....4-37

\* The actual shape may differ from the illustration.

ODM012001

■ Rear view

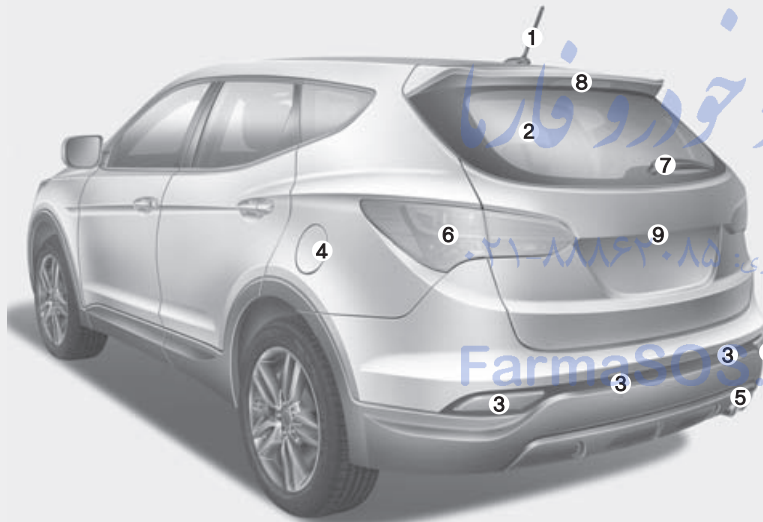

- 1. Antenna .....4-190
- 2. Defroster .....4-141
- 3. Parking assist system .....4-101
- 4. Fuel filler lid .....4-34
- 5. Towing hook .....6-32
- 6. Rear combination lamp .....7-98
- 7. Rear window wiper blade .....7-54
- 8. High mounted stop lamp .....7-101
- 9. Rearview camera.....4-119

\* The actual shape may differ from the illustration.

## INTERIOR OVERVIEW (I)

■ Left-Hand drive type

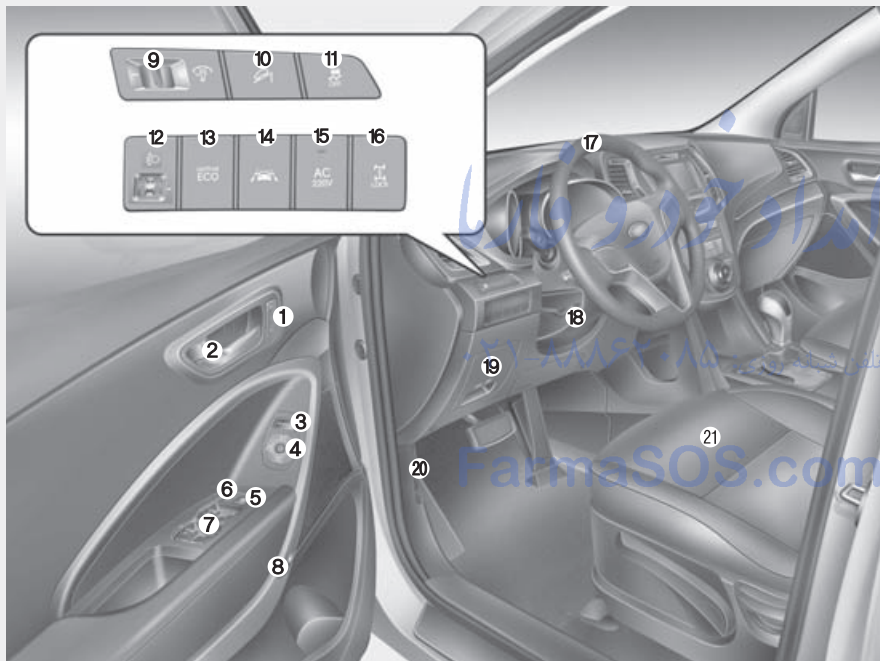

1. Driver position memory system button .....3-9
2. Inside door handle .....4-20
3. Outside rearview mirror folding .....4-54
4. Outside rearview mirror control .....4-53
5. Power window lock button .....4-30
6. Central door lock switch .....4-21
7. Power window switch .....4-27
8. Fuel-filler lid opener .....4-34
9. Instrument panel illumination control knob .....4-58
10. DBC button .....5-60
11. ESC OFF button .....5-53
12. Headlight leveling device .....4-129
13. Active ECO button .....5-77
14. LDWS button .....5-73
15. AC inverter button.....4-182
16. 4WD LOCK button .....5-29
17. Steering wheel .....4-42
18. Tilt and telescopic steering control lever .....4-43
19. Inner panel fuse panel..... 7-71
20. Hood release lever .....4-32
21. Seat .....3-2

\* The actual shape may differ from the illustration.

ODMEIN2900



■ Right-Hand drive type

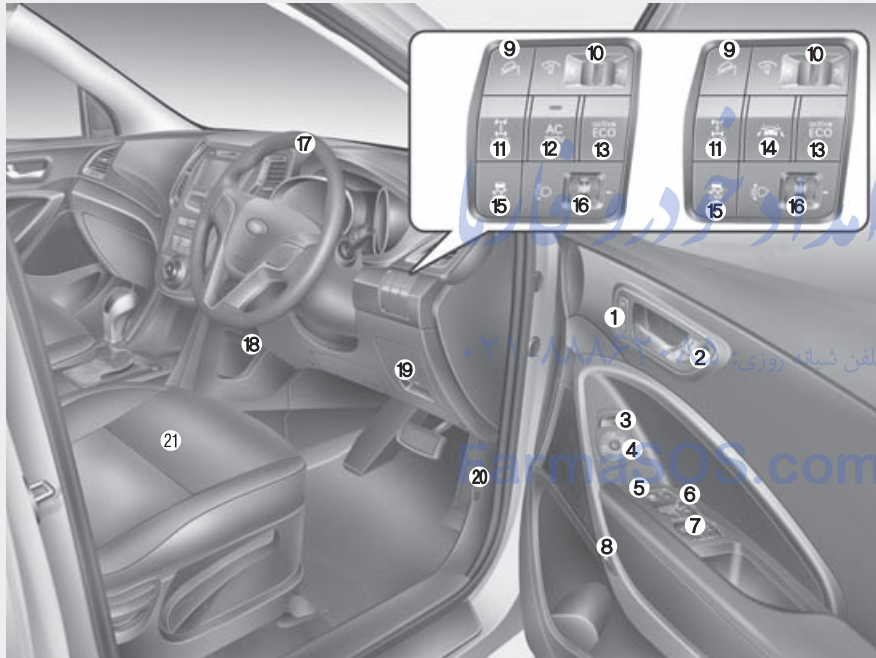

1. Driver position memory system button .....3-9
2. Inside door handle .....4-20
3. Outside rearview mirror folding .....4-54
4. Outside rearview mirror control .....4-53
5. Power window lock button .....4-30
6. Central door lock switch .....4-21
7. Power window switch .....4-27
8. Fuel-filler lid opener .....4-34
9. DBC button.....5-60
10. Instrument panel illumination control knob .....4-58
11. 4WD LOCK button .....5-29
12. AC inverter button.....4-182
13. Active ECO button .....5-77
14. LDWS button .....5-73
15. ESC OFF button.....5-53
16. Headlight leveling device .....4-129
17. Steering wheel .....5-42
18. Tilt and telescopic steering control lever .....4-43
19. Inner panel fuse panel..... 7-71
20. Hood release lever .....4-32
21. Seat .....3-2

\* The actual shape may differ from the illustration.

ODMEIN2003R

## INTERIOR OVERVIEW (II)

■ Left-Hand drive type

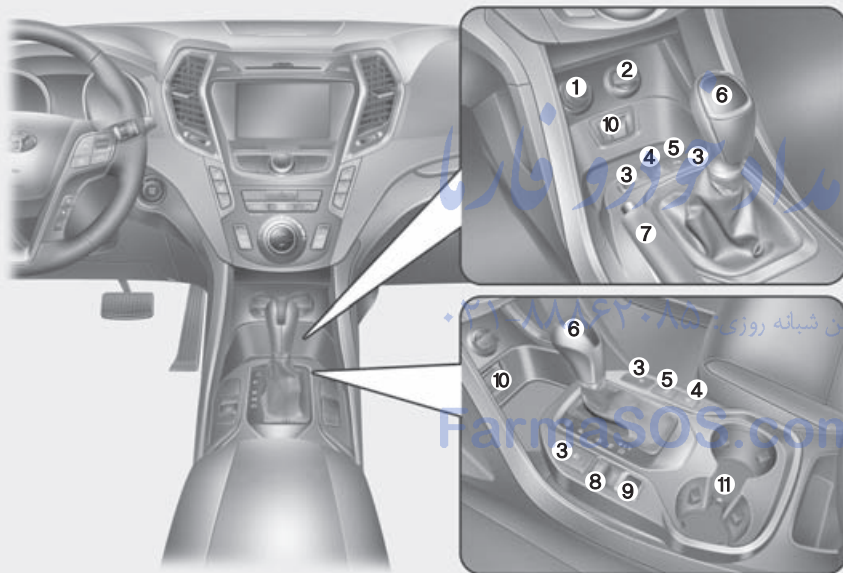

1. Cigarette lighter .....	4-178
2. Power outlet .....	4-181
3. Seat warmer (front) .....	3-13
4. SPAS button .....	4-110
5. Parking assist system button .....	4-101
6. Transaxle shift lever .....	5-17
7. Parking brake lever.....	5-39
8. AUTO HOLD button .....	5-49
9. EPB switch .....	5-42
10. Aux, USB and iPod.....	4-184
11. Cup holder .....	4-179

\* The actual shape may differ from the illustration.

■ Right-Hand drive type

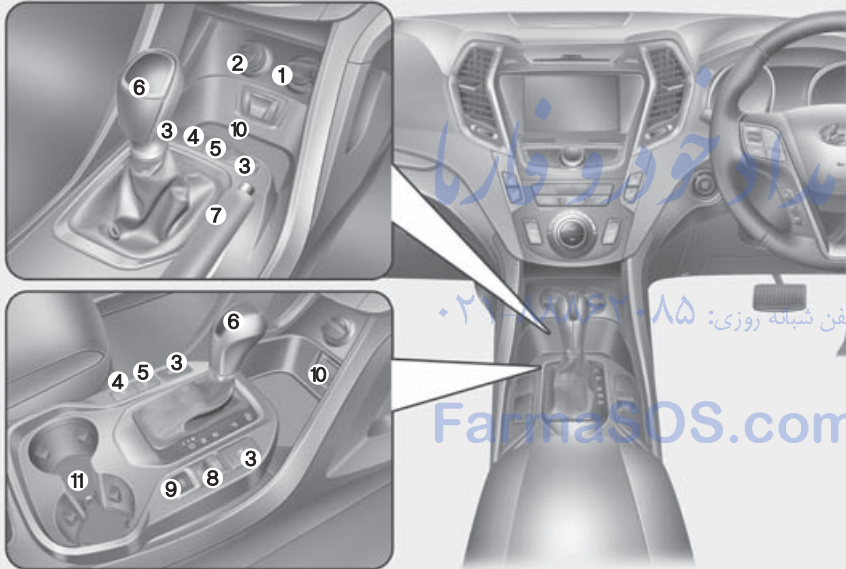

- 1. Cigarette lighter .....4-178
- 2. Power outlet .....4-181
- 3. Seat warmer (front) .....3-13
- 4. SPAS button .....4-110
- 5. Parking assist system button .....4-101
- 6. Transaxle shift lever .....5-17
- 7. Parking brake lever.....5-39
- 8. AUTO HOLD button .....5-49
- 9. EPB switch .....5-42
- 10. Aux, USB and iPod.....4-184
- 11. Cup holder .....4-179

\* The actual shape may differ from the illustration.

ODMEIN2006R

## INSTRUMENT PANEL OVERVIEW

■ Left-Hand drive type

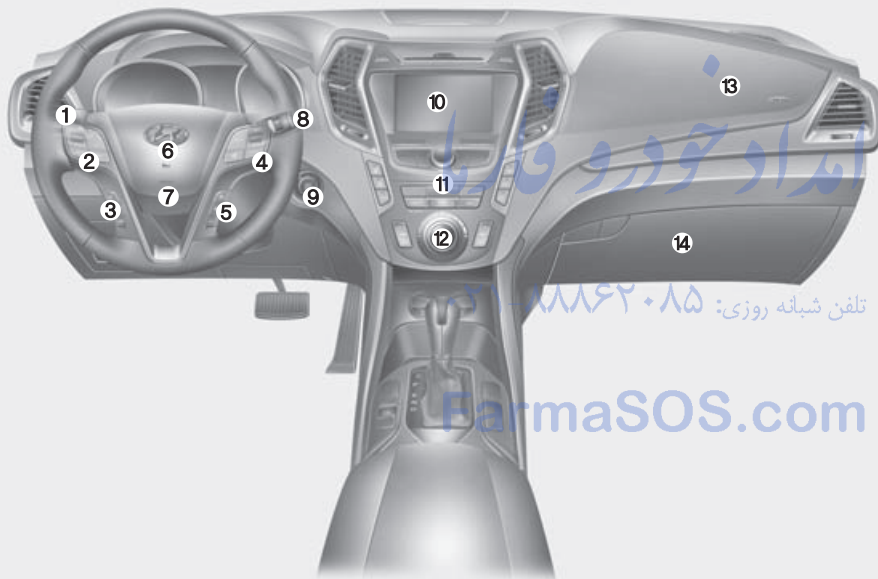

1. Lighting control lever .....4-122
2. Audio remote control buttons .....4-191
3. Bluetooth hands-free buttons .....4-241
4. Cruise control button .....5-64
5. LCD display control buttons .....4-58
6. Horn .....4-45
7. Driver's front air bag .....3-58
8. Wiper and washer control lever .....4-131
9. Ignition switch or Engine start/stop button .....5-6, 5-10
10. Audio .....4-190
11. Hazard warning flasher .....4-120
12. Climate control system .....4-143, 4-155
13. Passenger's front air bag .....3-58
14. Glove box .....4-174

\* The actual shape may differ from the illustration.

ODM012004

■ Right-Hand drive type

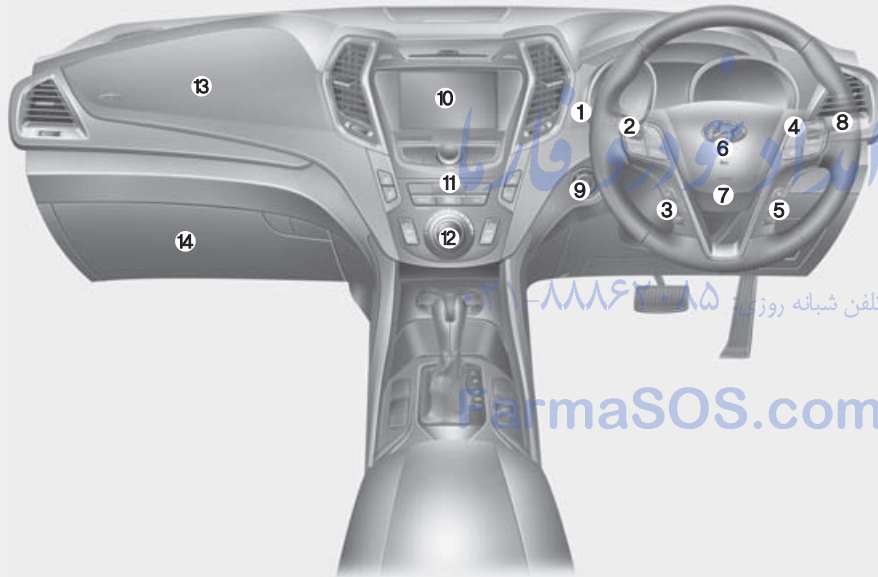

- 1. Lighting control lever .....4-122
- 2. Audio remote control buttons .....4-191
- 3. Bluetooth hands-free buttons .....4-241
- 4. Cruise control button .....5-64
- 5. LCD display control buttons .....4-58
- 6. Horn .....4-44
- 7. Driver's front air bag .....3-58
- 8. Wiper and washer control lever .....4-131
- 9. Ignition switch or Engine start/stop button .....5-6, 5-10
- 10. Audio .....4-190
- 11. Hazard warning flasher .....4-120
- 12. Climate control system .....4-143, 4-155
- 13. Passenger's front air bag .....3-58
- 14. Glove box .....4-174

\* The actual shape may differ from the illustration.

ODMEIN2004R

## ENGINE COMPARTMENT

### ■ Gasoline 2.4L - GDI

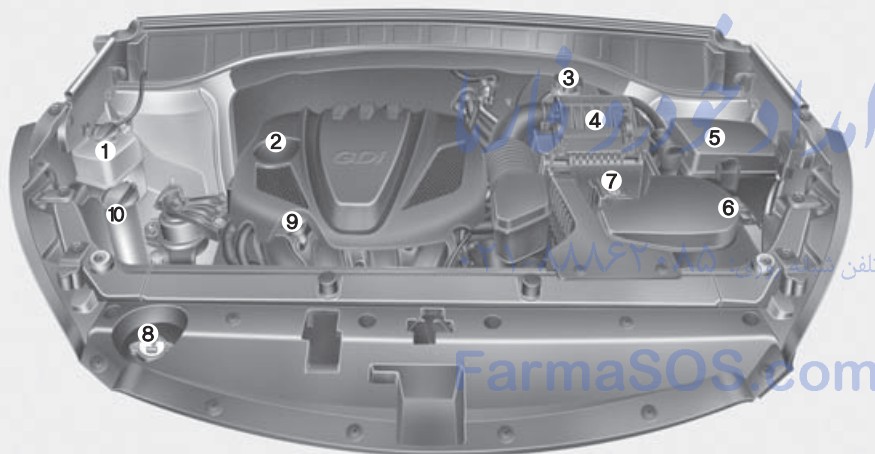

- 1. Engine coolant reservoir .....7-40
- 2. Engine oil filler cap .....7-39
- 3. Brake/clutch fluid reservoir .....7-43
- 4. Air cleaner.....7-48
- 5. Fuse box .....7-70
- 6. Negative battery terminal.....7-55
- 7. Positive battery terminal .....7-55
- 8. Radiator cap .....7-42
- 9. Engine oil dipstick.....7-38
- 10. Windshield washer fluid reservoir ...7-45

\* The actual shape may differ from the illustration.

ODMEMC2001

■ Gasoline 2.4L - MPI

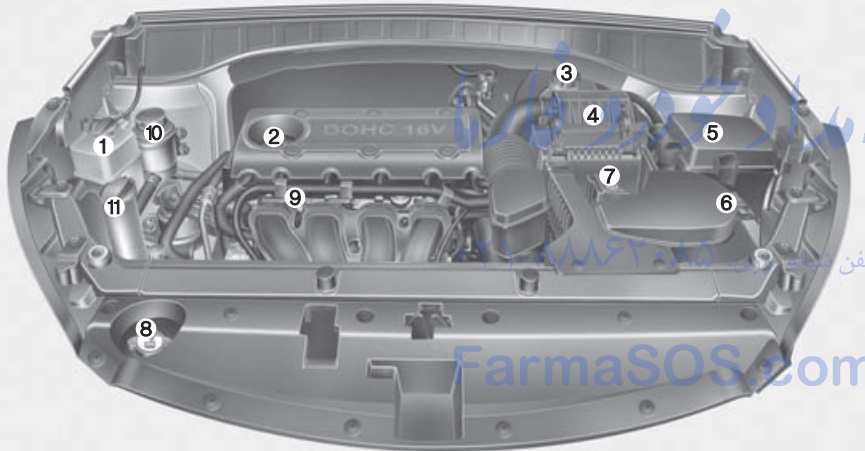

- 1. Engine coolant reservoir .....7-40
- 2. Engine oil filler cap .....7-39
- 3. Brake/clutch fluid reservoir .....7-43
- 4. Air cleaner.....7-48
- 5. Fuse box .....7-70
- 6. Negative battery terminal.....7-55
- 7. Positive battery terminal .....7-55
- 8. Radiator cap .....7-42
- 9. Engine oil dipstick .....7-38
- 10. Power steering fluid reservoir .....7-44
- 11. Windshield washer fluid reservoir ...7-45

\* The actual shape may differ from the illustration.

## ■ Gasoline 3.3L - MPI

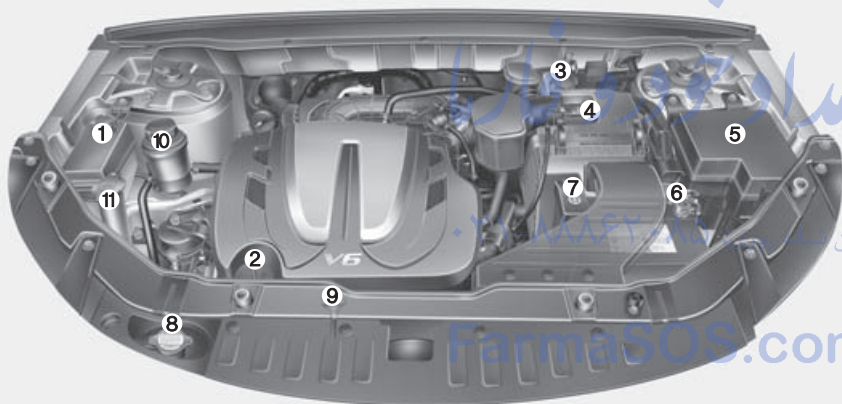

- 1. Engine coolant reservoir .....7-40
- 2. Engine oil filler cap .....7-39
- 3. Brake/clutch fluid reservoir .....7-43
- 4. Air cleaner.....7-48
- 5. Fuse box .....7-70
- 6. Negative battery terminal.....7-55
- 7. Positive battery terminal .....7-55
- 8. Radiator cap .....7-42
- 9. Engine oil dipstick.....7-38
- 10. Power steering fluid reservoir .....7-44
- 11. Windshield washer fluid reservoir ...7-45

\* The actual shape may differ from the illustration.



■ Diesel 2.0/2.2L

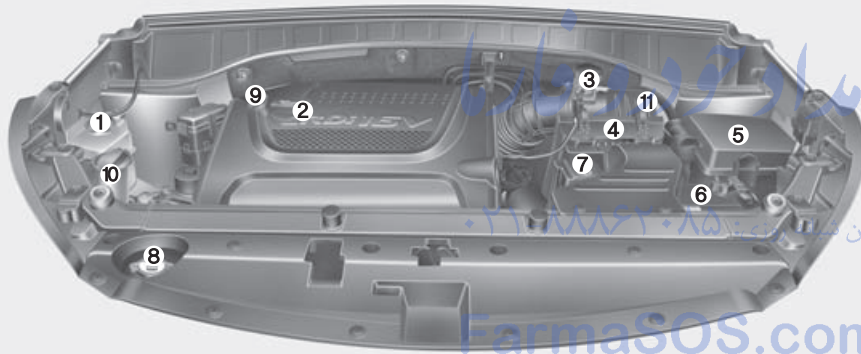

- 1. Engine coolant reservoir .....7-40
- 2. Engine oil filler cap .....7-39
- 3. Brake/clutch fluid reservoir .....7-43
- 4. Air cleaner.....7-48
- 5. Fuse box .....7-70
- 6. Negative battery terminal.....7-55
- 7. Positive battery terminal .....7-55
- 8. Radiator cap .....7-42
- 9. Engine oil dipstick.....7-38
- 10. Windshield washer fluid reservoir ...7-45
- 11. Fuel filter .....7-47

\* The actual shape may differ from the illustration.

# Safety features of your vehicle

Seat . . . . .	3-2	• SRS components and functions . . . . .	3-55
• Front seat adjustment - Manual . . . . .	3-5	• Driver's and passenger's front air bag . . . . .	3-58
• Front seat adjustment - Power . . . . .	3-7	• Side impact air bag . . . . .	3-64
• Driver position memory system . . . . .	3-9	• Curtain air bag . . . . .	3-65
• Headrest (for front seat) . . . . .	3-10	• SRS Care . . . . .	3-72
• Seat warmer . . . . .	3-13	• Additional safety precautions . . . . .	3-73
• Seat cooler (Air ventilation seat) . . . . .	3-15	• Air bag warning label . . . . .	3-74
• Seatback pocket . . . . .	3-16	Active hood lift system . . . . .	3-75
• Rear seat adjustment . . . . .	3-16		
• Headrest (for rear seat) . . . . .	3-22		
• Armrest (2nd row seat) . . . . .	3-24		
• Seat warmer (for 2nd row seat) . . . . .	3-25		
Seat belt . . . . .	3-26		
• Seat belt warning . . . . .	3-27		
• Lap/shoulder belt . . . . .	3-28		
• Pre-tensioner seat belt . . . . .	3-32		
• Seat belt precautions . . . . .	3-35		
• Care of seat belts . . . . .	3-37		
Child restraint system . . . . .	3-39		
• Tether Anchor system . . . . .	3-44		
• ISOFIX and Tether Anchorage system . . . . .	3-45		
Airbag-supplemental restraint system . . . . .	3-50		
• Do not install a child restraint on the front passenger's seat . . . . .	3-53		
• Air bag warning and indicator . . . . .	3-54		

امداد خودرو فارما

تلفن شبانه روزی: ۰۲۱-۸۸۸۶۴۸۵

FarmaOS.com

## SEATS

■ Left-Hand drive type

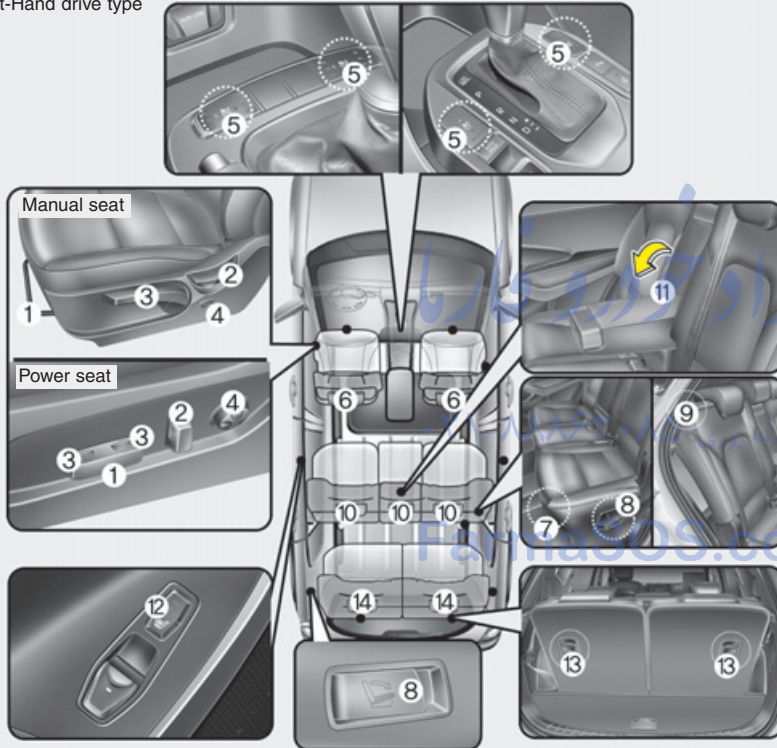

ODM032001

### Front seat

- (1) Forward and backward
- (2) Seatback angle
- (3) Seat cushion height (Driver's seat)
- (4) Lumbar support (Driver's seat)\*
- (5) Seat warmer\* /  
Seat cooler (air ventilation seat)\*
- (6) Headrest

### 2nd row seat

- (7) Forward and backward
- (8) Seatback angle and folding
- (9) Walk-in seat lever\*
- (10) Headrest
- (11) Armrest
- (12) Seat warmer\*

### 3rd row seat\*

- (13) Seatback folding
- (14) Headrest

\* if equipped

■ Right-Hand drive type

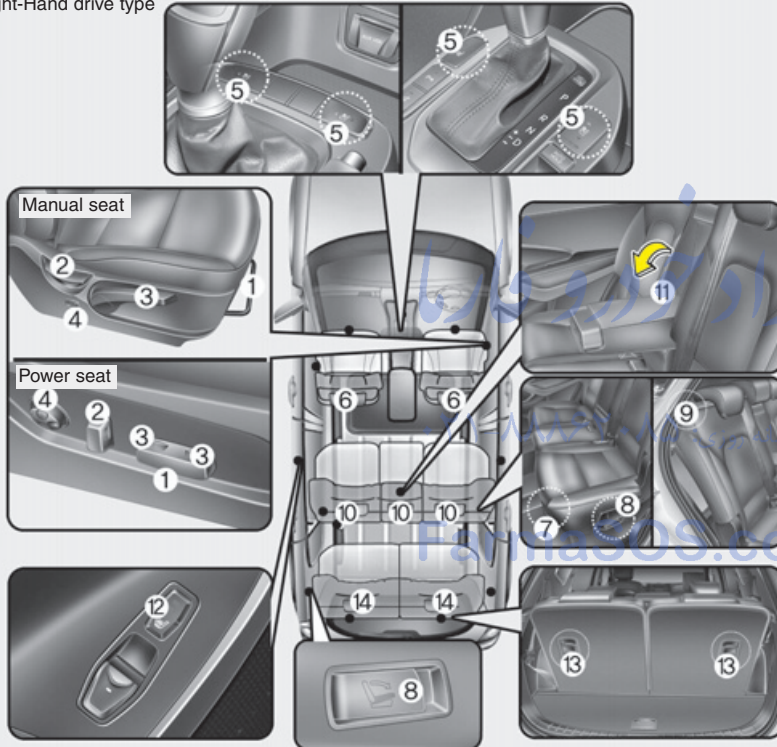

### Front seat

- (1) Forward and backward
- (2) Seatback angle
- (3) Seat cushion height (Driver's seat)
- (4) Lumbar support (Driver's seat)\*
- (5) Seat warmer\* /  
Seat cooler (air ventilation seat)\*
- (6) Headrest

### 2nd row seat

- (7) Forward and backward
- (8) Seatback angle and folding
- (9) Walk-in seat lever\*
- (10) Headrest
- (11) Armrest
- (12) Seat warmer\*

### 3rd row seat\*

- (13) Seatback folding
- (14) Headrest

\* if equipped

ODMESA2001R

**⚠ WARNING - Loose objects**

Loose objects in the driver's foot area could interfere with the operation of the foot pedals, possibly causing an accident. Do not place anything under the front seats.

**⚠ WARNING - Uprighting seat**

When you return the seatback to its upright position, hold the seatback and return it slowly and be sure there are no other occupants around the seat. If the seatback is returned without being held and controlled, the back of the seat could spring forward resulting in accidental injury to a person struck by the seatback.

**⚠ WARNING - Driver responsibility for front seat passenger**

Riding in a vehicle with a front seatback reclined could lead to serious or fatal injury in an accident. If a front seat is reclined during an accident, the occupant's hips may slide under the lap portion of the seat belt, applying great force to the unprotected abdomen. Serious or fatal internal injuries could result. The driver must advise the front passenger to keep the seatback in an upright position whenever the vehicle is in motion.

**⚠ WARNING**

Do not use a sitting cushion that reduces friction between the seat and passenger. The passenger's hips may slide under the lap portion of the seat belt during an accident or a sudden stop. Serious or fatal internal injuries could result because the seat belt can't operate normally.

**⚠ WARNING - Driver's seat**

- Never attempt to adjust seat while the vehicle is moving. This could result in loss of control, and an accident causing death, serious injury, or property damage.
- Do not allow anything to interfere with the normal position of the seatback. Storing items against a seatback or in any other way interfering with proper locking of a seatback could result in serious or fatal injury in a sudden stop or collision.
- Always drive and ride with your seatback upright and the lap portion of the seat belt snug and low across the hips. This is the best position to protect you in case of an accident.

(Continued)

(Continued)

- In order to avoid unnecessary and perhaps severe air bag injuries, always sit as far back as possible from the steering wheel while maintaining comfortable control of the vehicle. It is recommended that your chest is at least 250 mm (10 inches) away from the steering wheel.

**⚠ WARNING**

After adjusting the seat, always check that it is securely locked into place by attempting to move the seat forward or reverse without using the lock release lever. Sudden or unexpected movement of the driver's seat could cause you to lose control of the vehicle resulting in an accident.

**⚠ WARNING**

- Use extreme caution so that hands or other objects are not caught in the seat mechanisms while the seat is moving.
- Do not put a cigarette lighter on the floor or seat. When you operate the seat, gas may gush out of the lighter and cause fire.
- If there are occupants in the rear seats, be careful while adjusting the front seat position.

FarmaSOS.com

**Front seat adjustment - Manual (if equipped)**

*Forward and backward*

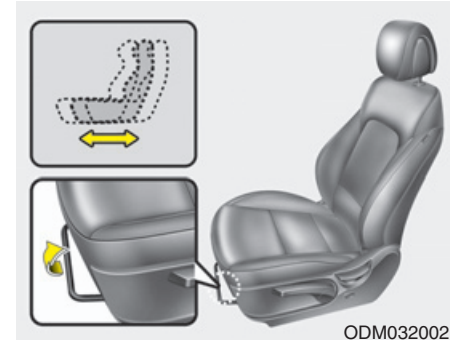

To move the seat forward or backward:

1. Pull the seat slide adjustment lever under the front edge of the seat cushion up and hold it.
2. Slide the seat to the position you desire.
3. Release the lever and make sure the seat is locked in place.

Adjust the seat before driving, and make sure the seat is locked securely by trying to move forward and backward without using the lever. If the seat moves, it is not locked properly.

### Seatback angle

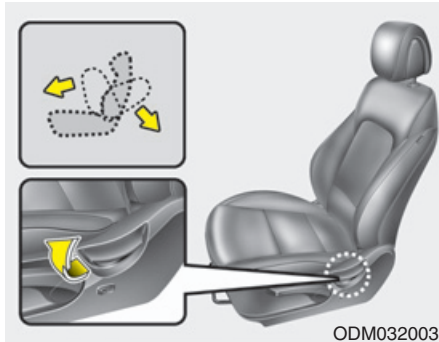

To recline the seatback:

1. Lean forward slightly and lift up on the seatback recline lever located on the outside of the seat at the rear.
2. Carefully lean back on the seat and adjust the seatback of the seat to the position you desire.
3. Release the lever and make sure the seatback is locked in place. (The lever **MUST** return to its original position for the seatback to lock.)

### Seat cushion height (for driver's seat, if equipped)

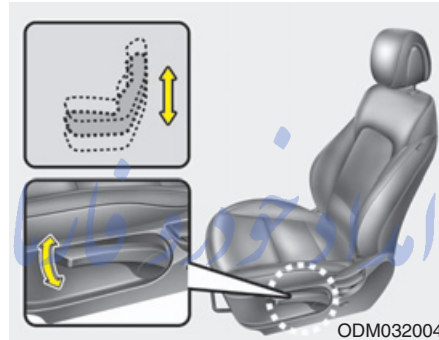

To change the height of the seat cushion, push the lever that is located on the outside of the seat cushion upwards or downwards.

- To lower the seat cushion, push down the lever several times.
- To raise the seat cushion, pull up the lever several times.

### Lumbar support (for driver's seat, if equipped)

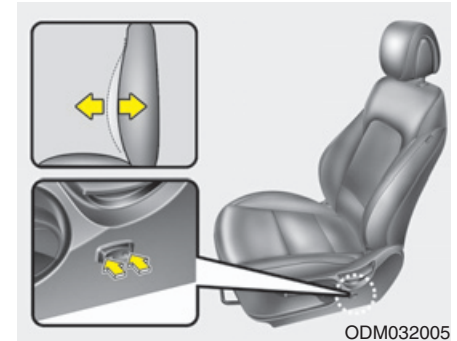

The lumbar support can be adjusted by pressing the lumbar support switch on the side of the seat.

1. Press the front portion of the switch to increase support, or the rear portion of the switch, to decrease support.
2. Release the switch once it reaches the desired position.

## Front seat adjustment - power (if equipped)

The front seat can be adjusted by using the control switches located on the outside of the seat cushion. Before driving, adjust the seat to the proper position so as to easily control the steering wheel, pedals and switches on the instrument panel.

### **⚠ WARNING**

The power seat is operable with the ignition OFF.  
Children should never be left unattended in the vehicle.

### **⚠ CAUTION**

- *The power seat is driven by an electric motor. Stop operating once the adjustment is completed. Excessive operation may damage the electrical equipment.*
- *When in operation, the power seat consumes a large amount of electrical power. To prevent unnecessary charging system drain, don't adjust the power seat longer than necessary while the engine is not running.*
- *Do not operate two or more power seat control switches at the same time. Doing so may result in power seat motor or electrical component malfunction.*

## Forward and backward

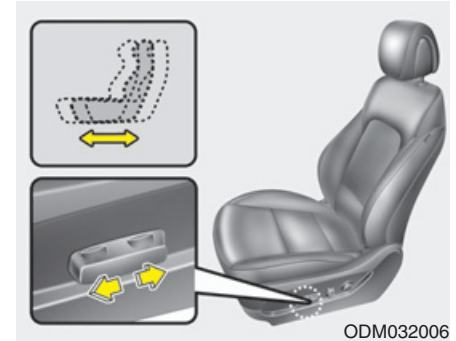

1. Push the control switch forward or backward to move the seat to the desired position.
2. Release the switch once the seat reaches the desired position.



### Seatback angle

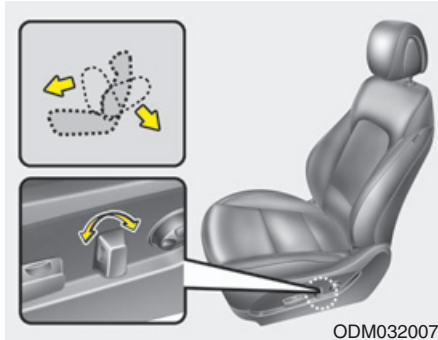

1. Push the control switch forward or backward to move the seatback to the desired angle.
2. Release the switch once the seat reaches the desired position.

### Seat height (for driver's seat)

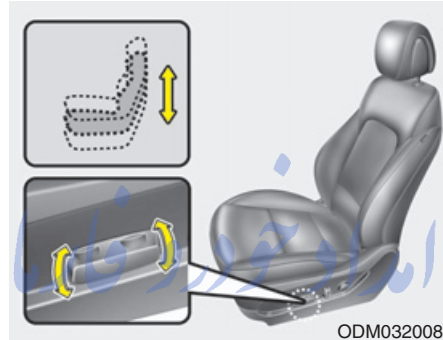

1. Pull the front portion of the control switch up to raise or down to lower the front part of the seat cushion. Pull the rear portion of the control switch up to raise or down to lower the rear part of the seat cushion.
2. Release the switch once the seat reaches the desired position.

### Lumbar support (for driver's seat)

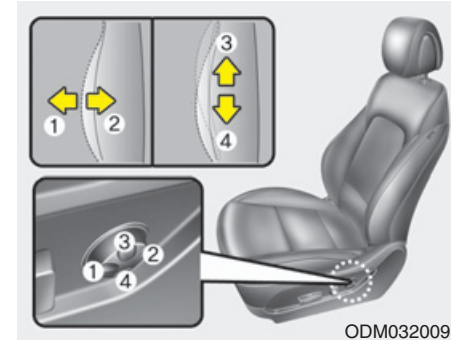

The lumbar support can be adjusted by pressing the switch.

1. Press the front portion (1) of the switch to increase support, or the rear portion (2) of the switch, to decrease support.
2. Release the switch once it reaches the desired position.
3. Press the upper portion (3) of the switch to move the support position up, or press the lower portion (4) of the switch, to move the support position down.
4. Release the switch once it reaches the desired position.

## Driver position memory system (if equipped, for power seat)

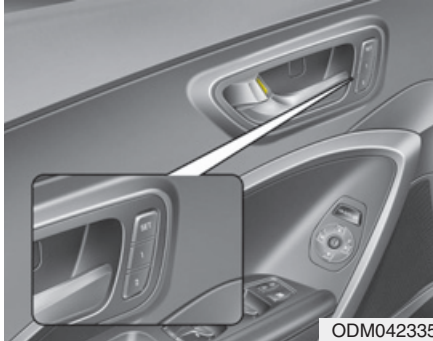

A driver position memory system is provided to store and recall the driver seat and outside rearview mirror position with a simple button operation. By saving the desired position into the system memory, different drivers can reposition the driver seat based upon their driving preference. If the battery is disconnected, the position memory will be erased and the driving position should be restored in the system.

### **⚠ WARNING**

**Never attempt to operate the driver position memory system while the vehicle is moving.**

**This could result in loss of control, and an accident causing death, serious injury, or property damage.**

امداد خودرو فارما

تلفن شبانه روزی: ۰۲۱-۸۸۸۶۲۰۸۵

FarmaSOS.com

## *Storing positions into memory using the buttons on the door*

### Storing driver's seat positions

1. Shift the shift lever into P or N (for Automatic transaxle) or Neutral (for manual transaxle) while the engine start/stop button is ON or ignition switch ON.
2. Adjust the driver's seat and outside rearview mirror comfortable for the driver.
3. Press SET button on the control panel. The system will beep once.
4. Press one of the memory buttons (1 or 2) within 5 seconds after pressing the SET button. The system will beep twice when memory has been successfully stored.

### Recalling positions from memory

1. Shift the shift lever into P or N (for Automatic transaxle) or Neutral (for manual transaxle) while the engine start/stop button is ON or ignition switch ON.
2. To recall the position in the memory, press the desired memory button (1 or 2). The system will beep once, then the driver's seat will automatically adjust to the stored position.

Adjusting the control switch for the driver's seat while the system is recalling the stored position will cause the movement to stop and move in the direction that the control switch is moved.

#### **⚠ WARNING**

**Use caution when recalling the adjustment memory while sitting in the vehicle. Push the seat position control switch to the desired position immediately if the seat moves too far in any direction.**

### *Easy access function (if equipped)*

The system will move the driver's seat automatically as follows:

- Without smart key system
  - It will move the driver's seat rearward when the ignition key is removed and front driver's door is opened.
  - It will move the driver's seat forward when the ignition key is inserted.
- With smart key system
  - It will move the driver's seat rearward when the engine start/stop button is changed to the OFF position and front driver's door is opened.
  - It will move the driver's seat forward when the engine start/stop button is changed to the ACC or START position.

You can activate or deactivate this feature. Refer to "User settings" in section 4.

### Headrest (for front seat)

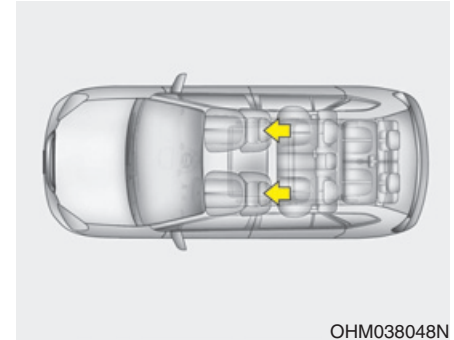

OHM038048N

The driver's and front passenger's seats are equipped with a headrest for the occupant's safety and comfort.

The headrest not only provides comfort for the driver and front passenger, but also helps to protect the head and neck in the event of a collision.

**⚠ WARNING**

- For maximum effectiveness in case of an accident, the headrest should be adjusted so the middle of the headrest is at the same height as the center of gravity of an occupant's head. Generally, the center of gravity of most people's head is similar with the height of the top of their eyes. Also, adjust the headrest as close to your head as possible. For this reason, the use of a cushion that holds the body away from the seat-back is not recommended.
- Do not operate the vehicle with the headrests removed as severe injury to the occupants may occur in the event of an accident. Headrests may provide protection against neck injuries when properly adjusted.
- Do not adjust the headrest position of the driver's seat while the vehicle is in motion.

**Forward and backward adjustment (if equipped)**



The headrest may be adjusted forward to 4 different positions by pulling the headrest forward to the desired detent. To adjust the headrest to its furthest backwards position, pull it fully forward to the farthest position and release it. Adjust the headrest so that it properly supports the head and neck.

**Adjusting the height up and down (if equipped)**

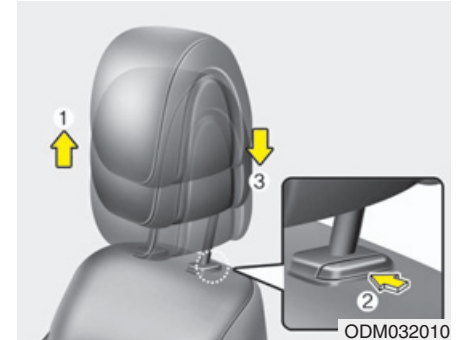

To raise the headrest :

1. Pull it up to the desired position (1).

To lower the headrest :

1. Push and hold the release button (2) on the headrest support.
2. Lower the headrest to the desired position (3).

## Removal and installation

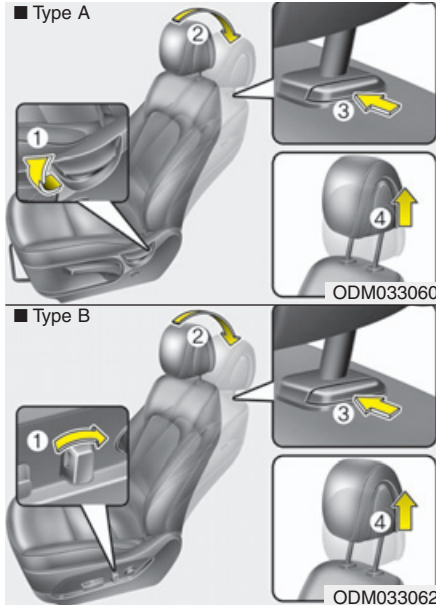

To remove the headrest:

1. Recline the seatback (2) with the recline lever or switch (1).
2. Raise headrest as far as it can go.

3. Press the headrest release button (3) while pulling the headrest up (4).

**⚠ WARNING**  
**NEVER allow anyone to ride in a seat with the headrest removed.**

امداد خودرو فارما

تلفن شبانه روزی: ۰۲۱-۸۸۸۶۲۰۸۵

FarmaSOS.com

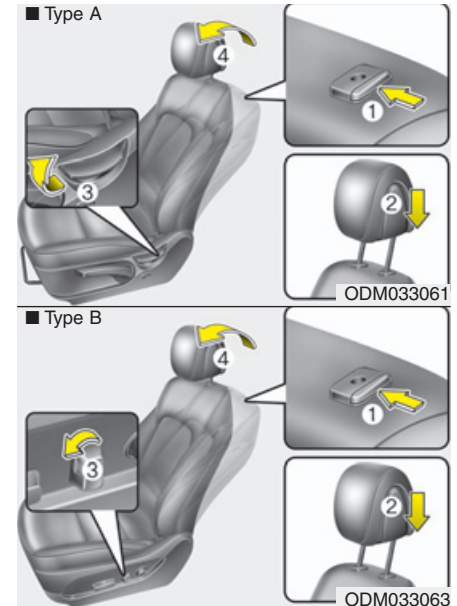

To reinstall the headrest :

1. Put the headrest poles (2) into the holes while pressing the release button (1).
2. Recline the seatback (4) with the recline lever or switch (3).

3. Adjust the headrest to the appropriate height.

**⚠ WARNING**

Always make sure the headrest locks into position after re-installing and adjusting it properly.

**Seat warmer (if equipped)**

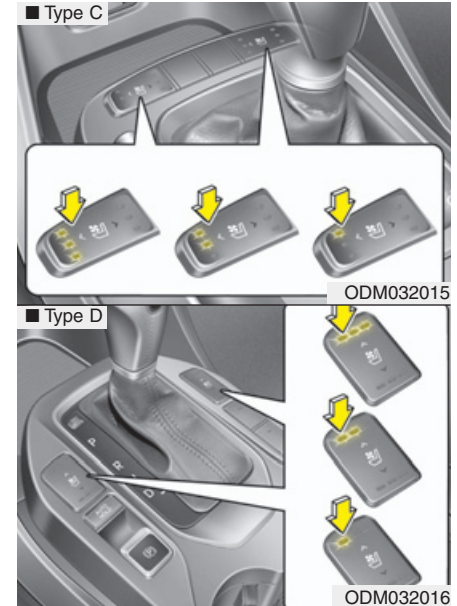
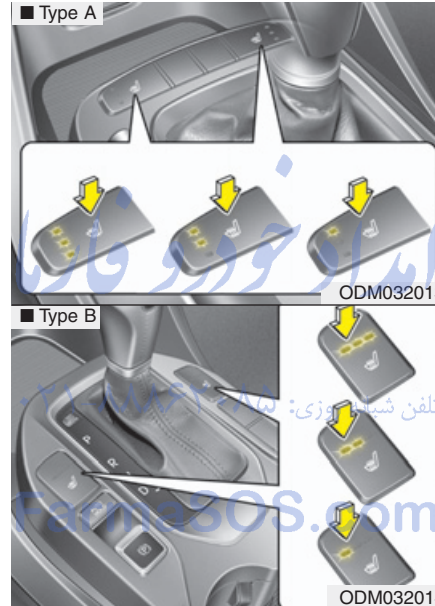

The seat warmer is provided to warm the front seats during cold weather. With the ignition switch in the ON position, push either of the switches to warm the driver's seat or the front passenger's seat.

During mild weather or under conditions where the operation of the seat warmer is not needed, keep the switches in the "OFF" position.

- Each time you press the switch, the temperature setting of the seat will change as follows :

OFF → HIGH (☀️☀️☀️) → MIDDLE (☀️☀️) → LOW (☀️)  
↑

- The seat warmer defaults to the OFF position whenever the ignition switch is turned on.

### \* NOTICE

With the seat warmer switch in the ON position, the heating system in the seat turns off or on automatically depending on the seat temperature.

### ⚠️ CAUTION

- *When cleaning the seats, do not use an organic solvent such as paint thinner, benzene, alcohol and gasoline. Doing so may damage the surface of the heater or seats.*
- *To prevent overheating the seat warmer, do not place anything on the seats that insulates against heat, such as blankets, cushions or seat covers while the seat warmer is in operation.*
- *Do not place heavy or sharp objects on seats equipped with seat warmers. Damage to the seat warming components could occur.*
- *Do not change the seat cover. It may damage the seat warmer or airventilation system.*

### ⚠️ WARNING - Seat warmer burns

Passengers should use extreme caution when using seat warmers due to the possibility of excess heating or burns. The seat warmer may cause burns even at low temperatures, especially if used for long periods of time. In particular, the driver must exercise extreme care for the following types of passengers:

1. Infants, children, elderly or handicapped persons, or hospital outpatients
2. Persons with sensitive skin or those that burn easily
3. Fatigued individuals
4. Intoxicated individuals
5. Individuals taking medication that can cause drowsiness or sleepiness (sleeping pills, cold tablets, etc.)

## Seat cooler (Air ventilation seat) (if equipped)

■ Type A

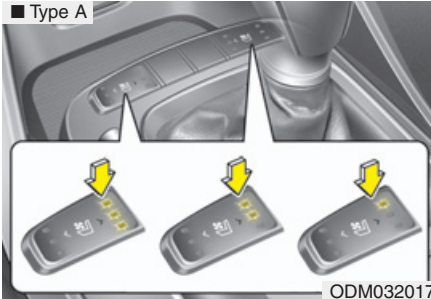

ODM032017

■ Type B

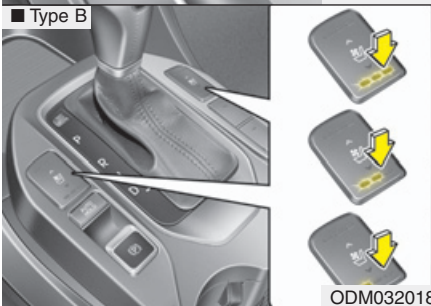

ODM032018

The temperature setting of the seat changes according to the switch position.

- If you want to warm your seat cushion, press the switch (red color).
- If you want to cool your seat cushion, press the switch (blue color).
- Each time you press the button, the airflow will change as follows:

OFF → HIGH (☀☀☀) → MIDDLE (☀☀) → LOW (☀)



- The seat warmer (with air ventilation) defaults to the OFF position whenever the ignition switch is turned on.

تلفن شبانه روزی: ۰۲۱-۸۸۸۶۲۰۸۵

FarmaSOS.com

## ⚠ CAUTION

- *When cleaning the seats, do not use an organic solvent such as paint thinner, benzene, alcohol and gasoline. Doing so may damage the surface of the heater or seats.*
- *To prevent overheating the seat warmer, do not place anything on the seats that insulates against heat, such as blankets, cushions or seat covers while the seat warmer is in operation.*
- *Do not place heavy or sharp objects on seats equipped with seat warmers. Damage to the seat warming components could occur.*
- *Do not change the seat cover. It may damage the seat warmer or airventilation system.*



## Seatback pocket



The seatback pocket is provided on the back of the front passenger's and driver's seatbacks.

### **⚠ WARNING - Seatback pockets**

**Do not put heavy or sharp objects in the seatback pockets. In an accident they could come loose from the pocket and injure vehicle occupants.**

## Rear seat adjustment

### *Forward and backward (2nd row seat)*

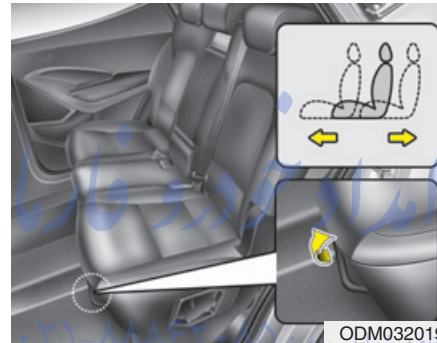

To move the seat forward or backward:

1. Pull the seat slide adjustment lever up and hold it.
2. Slide the seat to the position you desire.
3. Release the lever and make sure the seat is locked in place.

Adjust the seat before driving, and make sure the seat is locked securely by trying to move forward and backward without using the lever. If the seat moves, it is not locked properly.

## *Seatback angle (2nd row seat)*

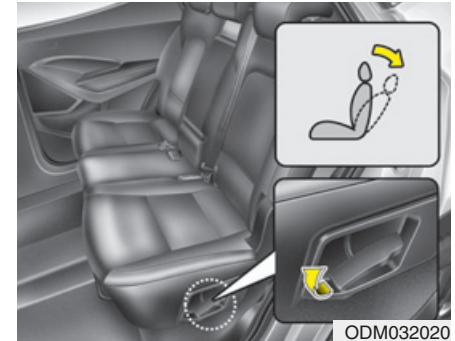

To recline the seatback:

1. Pull up the seatback recline lever.
2. Hold the lever and adjust the seatback of the seat to the position you desire.
3. Release the lever and make sure the seatback is locked in place. (The lever **MUST** return to its original position for the seatback to lock.)

**Walk-in seat  
(2nd row seat, if equipped)**

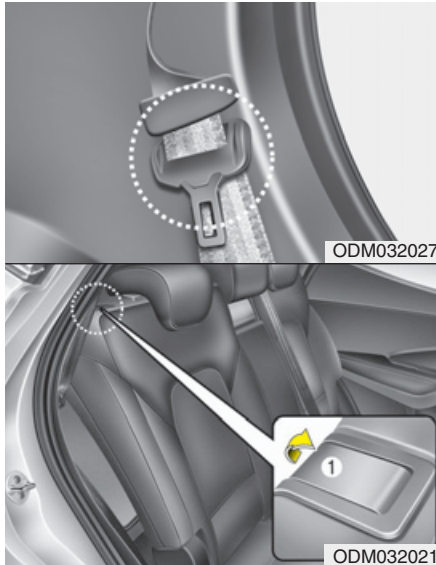

To get in or out of the 3rd row seat,

1. Routing the seat belt webbing through the rear seat belt guide clip. After inserting the seat belt, tighten the belt webbing by pulling it up.
2. Pull up the walk-in lever (1) on the 2nd row seatback.

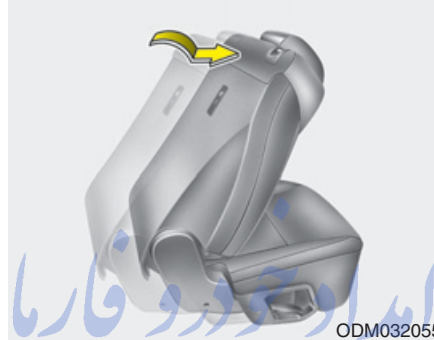

3. The 2nd row seatback will be folded and push the seat to the farthest forward position.

After getting in or out, slide the 2nd row seat to the farthest rearward position and pull the seatback firmly backward until it clicks into place. Make sure that the seat is locked in place.

**⚠ WARNING**

**Never attempt to adjust while the vehicle is moving or the 2nd row seat is occupied as the seat may suddenly move and cause the passenger on the seat to be injured.**

**Folding the rear seat**

The rear seatbacks can be folded to facilitate carrying long items or to increase the luggage capacity of the vehicle.

**⚠ WARNING**

**The purpose of the fold-down rear seatbacks is to allow you to carry longer objects that could not be accommodated in the cargo area.**

**Never allow passengers to sit on top of the folded down seatback while the vehicle is moving. This is not a proper seating position and no seat belts are available for use. This could result in serious injury or death in case of an accident or sudden stop. Objects carried on the folded down seatback should not extend higher than the top of the front seatbacks. This could allow cargo to slide forward and cause injury or damage during sudden stops.**

### ■ 2nd row seat

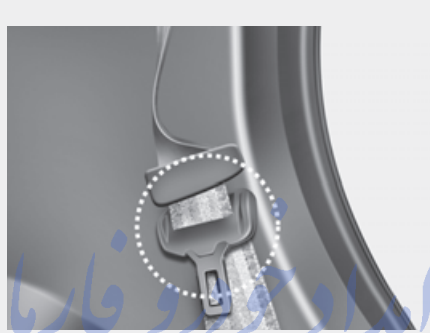
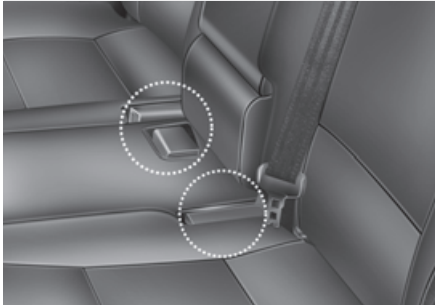

### ■ 3rd row seat



ODM032034/OXM039030/ODM032027/ODM032035

### To fold down the rear seatback

1. Insert the rear seat belt buckle in the pocket between the rear seatback and cushion, and insert the rear seat belt webbing in the guide to prevent the seat belt from being damaged.
2. Set the front seatback to the upright position and if necessary, slide the front seat forward.
3. Lower the rear headrests to the lowest position.

### ■ 2nd row seat



### ■ 3rd row seat

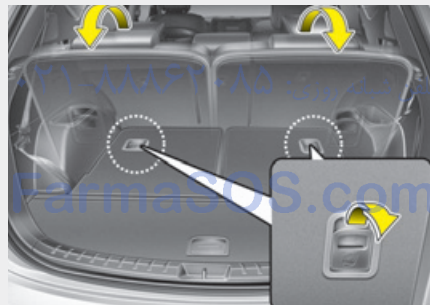
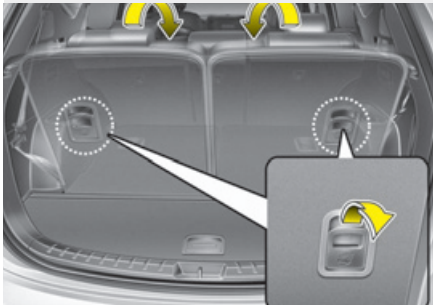

ODM032028/ODM032029/ODM032030/ODM032031

4. Pull on the seatback folding lever, then fold the seat toward the front of the vehicle. When you return the seatback to its upright position, always be sure it has locked into position by pushing on the top of the seatback.

5. To use the rear seat, lift and pull the seatback backward by pulling on the folding lever.

Pull the seatback firmly until it clicks into place.

Make sure the seatback is locked in place.

6. Return the rear seat belt to the proper position.

**2nd row seat folding**  
(from outside, if equipped)

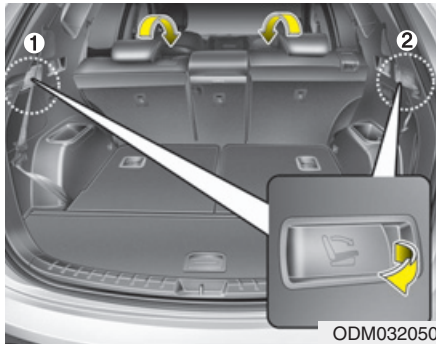

Pull the 2nd row seat back folding lever out.

The 2nd row seat back will be folded. If you pull the left side lever (1) out, left side seat back and center seat back will be folded.

If you pull the right side lever (2) out, right side seat back will be folded.

**⚠ WARNING - Rear seat folding**

**Do not fold the rear seats (2nd & 3rd row seats), if passengers, pets or luggage are in the rear seats.**

**It may cause injury or damage to passengers, pets, luggage.**

امداد خودرو فارما

تلفن شبانه روزی: ۰۲۱-۸۸۸۶۲۰۸۵

FarmaSOS.com

**To fold down the rear center seat-back (for 2nd row seat)**

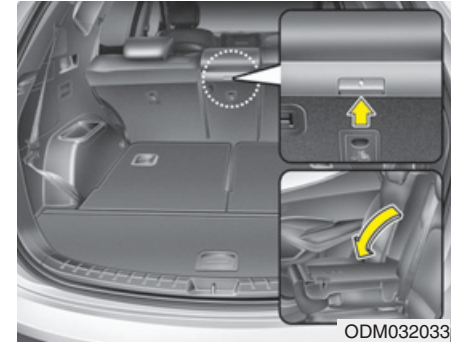

1. Lower the rear headrests to the lowest position.
2. Push the center seatback folding lever up, then fold the seat toward the front of the vehicle.

When you return the seatback to its upright position, always be sure it has locked into position by pushing on the top of the seatback.

**⚠ WARNING - 2nd row center seat folding**



- Do not fold the 2nd row center seat, if the occupants in the 3rd row seats, It may cause the injury to occupants by the seat device.

If occupants in the 3rd row seats, Fix the upright position of the 2nd row center seat.

- The 2nd row center seat back does not fix when it is folded. If you use the 2nd row center seat back folding function to carry long objects, you should fix the long object to prevent it from being thrown about the vehicle in a collision and causing injury to vehicle occupants.

**⚠ WARNING - Uprighting seat**

When you return the seatback to its upright position, hold the seatback and return it slowly. If the seatback is returned without holding it, the back of the seat could spring forward resulting in injury caused by being struck by the seatback.

تلفن شبانه روزی: ۰۲۱-۸۸۸۶۲۰۸۵

FarmaSOS.com

**⚠ CAUTION - Damaging rear seat belt buckles**

*When you fold the rear (2nd and/or 3rd row) seatback, insert the buckle in the pocket between the rear seatback and cushion. Doing so can prevent the buckle from being damaged by the rear seatback.*

**⚠ CAUTION - Rear seat belts**

*When returning the rear (2nd and/or 3rd row) seatbacks to the upright position, remember to return the rear shoulder belts to their proper position. Routing the seat belt webbing through the rear seat belt guides will help keep the belts from being trapped behind or under the seats.*

**⚠ WARNING - Cargo**

Cargo should always be secured to prevent it from being thrown about the vehicle in a collision and causing injury to the vehicle occupants. Do not place objects in the rear (2nd and/or 3rd row) seats, since they cannot be properly secured and may hit the front seat occupants in a collision.

**⚠ WARNING - Cargo loading**

Make sure the engine is off, the automatic transaxle is in P (Park) or the manual transaxle is in R (Reverse) or 1st, and the parking brake is securely applied whenever loading or unloading cargo. Failure to take these steps may allow the vehicle to move if the shift lever is inadvertently moved to another position.

**Headrest (for rear seat)**

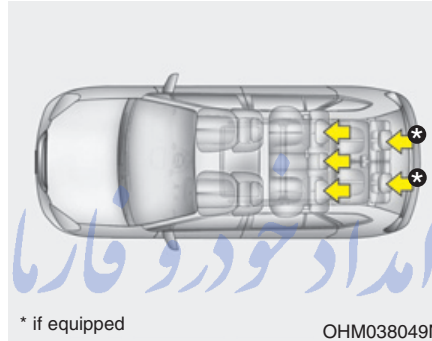

\* if equipped

OHM038049N

The rear seat(s) is equipped with headrests in all the seating positions for the occupant's safety and comfort.

The headrest not only provides comfort for passengers, but also helps protect the head and neck in the event of a collision.

**⚠ WARNING**

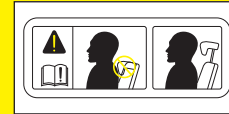

- For maximum effectiveness in case of an accident, the headrest should be adjusted so the middle of the headrest is at the same height as the center of gravity of an occupant's head. Generally, the center of gravity of most people's head is similar with the height of the top of their eyes. Also adjust the headrest as close to your head as possible. For this reason, the use of a cushion that holds the body away from the seatback is not recommended.

(Continued)

(Continued)

- Do not operate the vehicle with the headrests removed. Severe injury to an occupant may occur in the event of an accident. Headrests may provide protection against severe neck injuries when properly adjusted.

**CAUTION**

*When there is no occupant in the rear seats, adjust the height of the headrest to the lowest position. The rear seat headrest can reduce the visibility of the rear area.*

**Adjusting the height up and down**

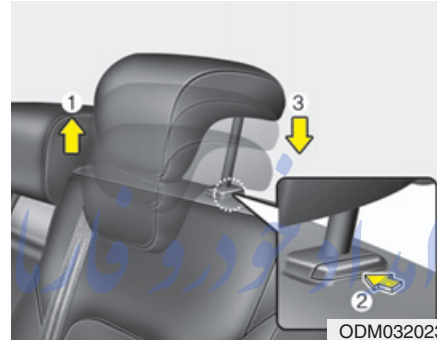

To raise the headrest :

1. Pull it up to the desired position (1).

To lower the headrest :

1. Push and hold the release button (2) on the headrest support
2. Lower the headrest to the desired position (3).

**Removal and installation**

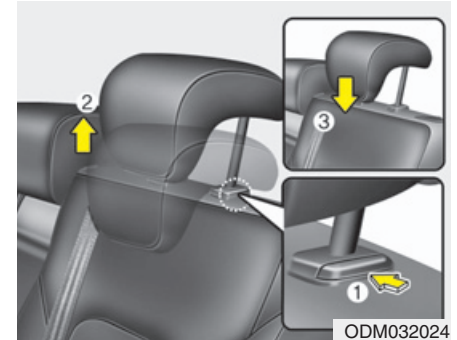

To remove the headrest :

1. Raise it as far as it can go.
2. Press the release button (1) while pulling upward (2).

To reinstall the headrest :

1. Put the headrest poles (3) into the holes while pressing the release button (1).
2. Adjust the headrest to the appropriate height.



**⚠ WARNING**

Make sure the headrest locks in position after adjusting it to properly protect the occupants.

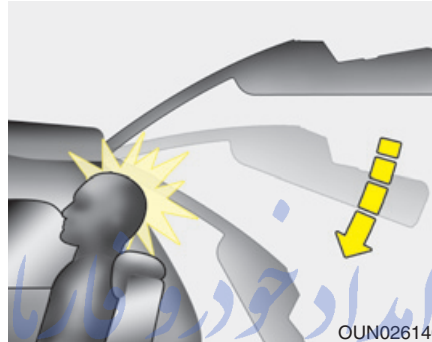

**⚠ WARNING**

If the tailgate is pushed down to close it when a passenger's head is not against a properly adjusted headrest or a tall person is seated, the tailgate may hit the occupant's head, which could cause injury.

**Armrest (2nd row seat)**



To use the armrest, pull it forward from the seatback.

## Seat warmer (if equipped, for 2nd row seat)



The seat warmer is provided to warm the rear seats during cold weather. With the ignition switch in the ON position, push either of the switches to warm rear seats.

During mild weather or under conditions where the operation of the seat warmer is not needed, keep the switches in the "OFF" position.

- Each time you press the button, the temperature setting of the seat will change as follows :



- The seat warmer defaults to the OFF position whenever the ignition switch is turned on.

### \* NOTICE

With the seat warmer switch in ON position, the heating system in the seat turns off or on automatically depending on the seat temperature.

FarmaSOS.com

### ⚠️ CAUTION - Seat damage

- *When cleaning the seats, do not use an organic solvent such as paint thinner, benzene, alcohol and gasoline. Doing so may damage the surface of the heater or seats.*
- *To prevent overheating the seat warmer, do not place anything on the seats that insulates against heat, such as blankets, cushions or seat covers on the seats while the seat warmer is in operation.*
- *Do not place heavy or sharp objects on seats equipped with seat warmers. Damage to the seat warming components could occur.*
- *Do not change the seat cover. It may damage the seat warmer or airventilation system.*

## SEAT BELTS

### Seat belt restraint system

#### **WARNING**

- For maximum restraint system protection, the seat belts must always be used whenever the car is moving.
- Seat belts are most effective when seatbacks are in the upright position.
- Children age 12 and younger must always be properly restrained in the rear seat. Never allow children to ride in the front passenger seat. If a child over 12 must be seated in the front seat, he/she must be properly belted and the seat should be moved as far back as possible.
- Never wear the shoulder belt under your arm or behind your back. An improperly positioned shoulder belt can cause serious injuries in a crash. The shoulder belt should be positioned midway over your shoulder across your collarbone.

(Continued)

(Continued)

- Never wear a seat belt over fragile objects. If there is a sudden stop or impact, the seat belt can damage it.
- Avoid wearing twisted seat belts. A twisted belt can't do its job as well. In a collision, it could even cut into you. Be sure the belt webbing is straight and not twisted.
- Be careful not to damage the belt webbing or hardware. If the belt webbing or hardware is damaged, replace it.

#### **WARNING**

Seat belts are designed to bear upon the bony structure of the body, and should be worn low across the front of the pelvis or the pelvis, chest and shoulders, as applicable; wearing the lap section of the belt across the abdominal area must be avoided.

(Continued)

(Continued)

Seat belts should be adjusted as firmly as possible, consistent with comfort, to provide the protection for which they have been designed.

A slack belt will greatly reduce the protection afforded to the wearer.

Care should be taken to avoid contamination of the webbing with polishes, oils and chemicals, and particularly battery acid. Cleaning may safely be carried out using mild soap and water. The belt should be replaced if webbing becomes frayed, contaminated or damaged. It is essential to replace the entire assembly after it has been worn in a severe impact even if damage to the assembly is not obvious. Belts should not be worn with straps twisted. Each seat belt assembly must only be used by one occupant; it is dangerous to put a belt around a child being carried on the occupant's lap.

**⚠ WARNING**

- No modifications or additions should be made by the user which will either prevent the seat belt adjusting devices from operating to remove slack, or prevent the seat belt assembly from being adjusted to remove slack.
- When you fasten the seat belt, be careful not to latch the seat belt in buckles of other seat. It's very dangerous and you may not be protected by the seat belt properly.
- Do not unfasten the seat belt and do not fasten and unfasten the seat belt repeatedly while driving. This could result in loss of control, and an accident causing death, serious injury, or property damage.

(Continued)

(Continued)

- When fastening the seat belt, make sure that the seat belt does not pass over objects that are hard or can break easily.
- Make sure there is nothing in the buckle. The seat belt may not be fastened securely.

امداد خودرو فارما

تلفن شبانه روزی: ۰۲۱-۸۸۸۶۲۰۸۵

FarmaSOS.com

*Seat belt warning*



**Type A**

As a reminder to the driver, the seat belt warning light will blink for approximately 6 seconds each time you turn the ignition switch ON regardless of belt fastening.

If the driver's seat belt is unfastened after the ignition switch is ON, the seat belt warning light blinks again for approximately 6 seconds.

If the driver's seat belt is not fastened when the ignition switch is turned ON or if it is unfastened after the ignition switch is ON, the seat belt warning chime will sound for approximately 6 seconds. At this time, if the seat belt is fastened, the chime will stop at once. (if equipped)

### Type B

As a reminder to the driver, the driver's seat belt warning lights will illuminate for approximately 6 seconds each time you turn the ignition switch ON regardless of belt fastening.

If the driver's seat belt is not fastened when the ignition switch is turned ON or if it is disconnected after the ignition switch is turned ON, the seat belt warning light will illuminate until the belt is fastened.

If you continue not to fasten the seat belt and you drive over 9 km/h, the illuminated warning light will start to blink until you drive under 6 km/h.

If you continue not to fasten the seat belt and you drive over 20 km/h (12 mph) the seat belt warning chime will sound for approximately 100 seconds and the corresponding warning light will blink.

### Lap/shoulder belt

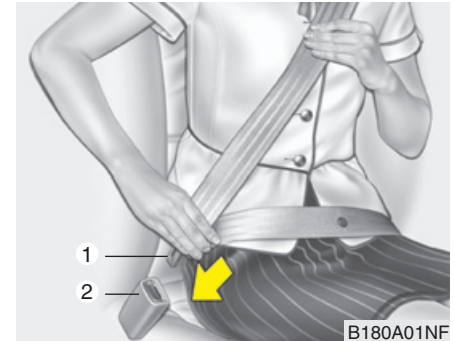

#### To fasten your seat belt:

To fasten your seat belt, pull it out of the retractor and insert the metal tab (1) into the buckle (2). There will be an audible "click" when the tab locks into the buckle.

The seat belt automatically adjusts to the proper length only after the lap belt portion is adjusted manually so that it fits snugly around your hips. If you lean forward in a slow, easy motion, the belt will extend and let you move around. If there is a sudden stop or impact, however, the belt will lock into position. It will also lock if you try to lean forward too quickly.

**\* NOTICE**

If you are not able to pull out the seat belt from the retractor, firmly pull the belt out and release it. Then you will be able to pull the belt out smoothly.

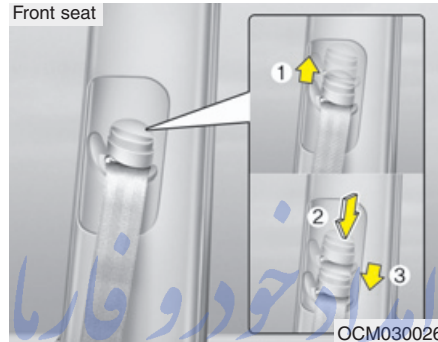
**Height adjustment**

You can adjust the height of the shoulder belt anchor to one of 4 positions for maximum comfort and safety.

If the height of the seat belt is too near your neck, you will not be getting the most effective protection. The shoulder portion should be adjusted so that it lies across your chest and midway over your shoulder nearest the door and not your neck.

To adjust the height of the seat belt anchor, lower or raise the height adjuster into an appropriate position.

To raise the height adjuster, pull it up (1). To lower it, push it down (3) while pressing the height adjuster button (2). Release the button to lock the anchor into position. Try sliding the height adjuster to make sure that it has locked into position.

**⚠ WARNING**

- **Verify the shoulder belt anchor is locked into position at the appropriate height. Never position the shoulder belt across your neck or face. Improperly positioned seat belts can cause serious injuries in an accident.**
- **Failure to replace seat belts after an accident could leave you with damaged seat belts that will not provide protection in the event of another collision leading to personal injury or death. Replace your seat belts after being in an accident as soon as possible.**

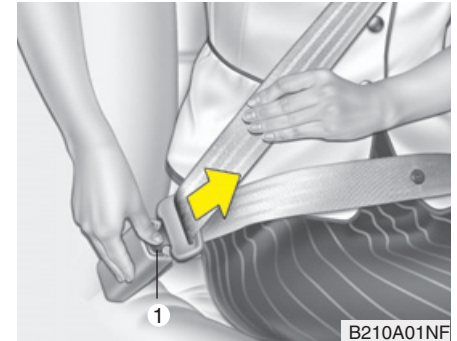
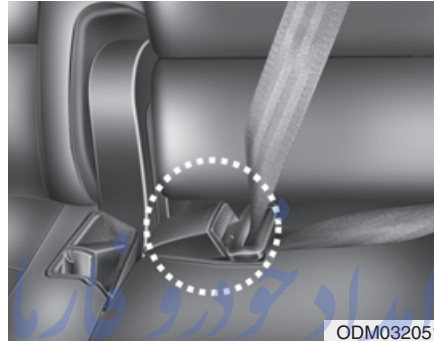
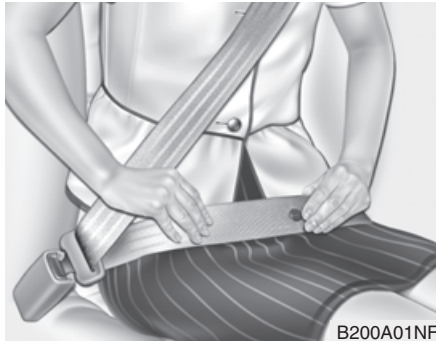

### **⚠ WARNING**

You should place the lap belt portion as low as possible and snugly across your hips, not on your waist. If the lap belt is located too high on your waist, it may increase the chance of injury in the event of a collision. Both arms should not be under or over the belt. Rather, one should be over and the other under, as shown in the illustration.

Never wear the seat belt under the arm nearest the door.

When using the rear center seat belt, the buckle with the "CENTER" mark must be used.

تلفن شبانه روزی: ۰۲۱-۸۸۸۶۲۰۸۵

[FarmaSOS.com](http://FarmaSOS.com)

### **To release the seat belt:**

The seat belt is released by pressing the release button (1) in the locking buckle. When it is released, the belt should automatically draw back into the retractor.

If this does not happen, check the belt to be sure it is not twisted, then try again.

## Stowing the rear seat belt

■ 2nd row seat

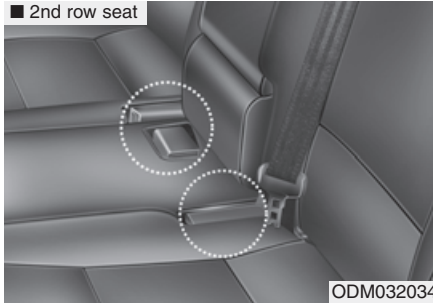

ODM032034

■ 3rd row seat (if equipped)

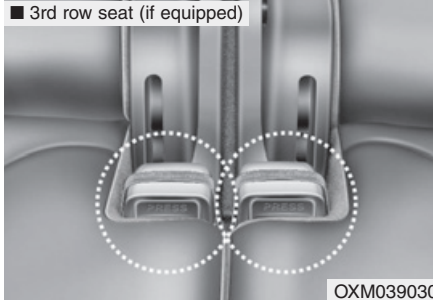

OXM039030

- The rear seat belt buckles can be stowed in the pocket between the rear seatback and cushion when not in use.

■ 2nd row seat

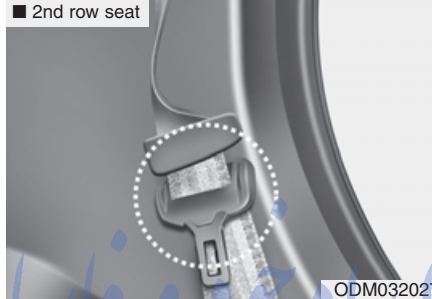

ODM032027

■ 3rd row seat (if equipped)

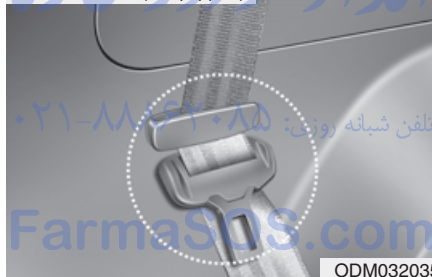

ODM032035

- Routing the seat belt webbing through the rear seat belt guides will help keep the belts from being trapped behind or under the seats. After inserting the seat belt, tighten the belt webbing by pulling it up.

### CAUTION

*When using the seat belt, use it after taking it out of the guides. If you pull the seat belt when it is stored in the guides, it may damage the guides and/or belt webbing.*



### Pre-tensioner seat belt (if equipped)



ODMESA2023

Your vehicle is equipped with driver's and front passenger's pre-tensioner seat belts (retractor pretensioner and EFD (Emergency Fastening Device)). The pre-tensioner seat belts can be activated, where the frontal collision is severe enough, together with the air bags.

When the vehicle stops suddenly, or if the occupant tries to lean forward too quickly, the seat belt retractor will lock into position. In certain frontal collisions, the pre-tensioner will activate and pull the seat belt into tighter contact against the occupant's body.

#### (1) Retractor Pretensioner

The purpose of the retractor pretensioner is to make sure that the shoulder belts fit in tightly against the occupant's upper body in certain frontal collisions.

#### (2) EFD (Emergency Fastening Device)

The purpose of the EFD is to make sure that the pelvis belts fit in tightly against the occupant's lower body in certain frontal collisions.

If the system senses excessive tension on the driver or passenger's seat belt when the pre-tensioner system activates, the load limiter inside the retractor pretensioner will release some of the pressure on the affected seat belt. (if equipped)

#### \* NOTICE - if equipped with rollover sensor

The pre-tensioner will activate not only in a frontal collision but also in a side collision or rollover, if the vehicle is equipped with a side or curtain air bag.

#### \* NOTICE - without rollover sensor

The pre-tensioner will activate not only in a frontal collision but also in a side collision, if the vehicle is equipped with a side or curtain air bag.

#### **⚠ WARNING**

**For your safety, be sure that the belt webbing is not loose or twisted and always sit properly on your seat.**

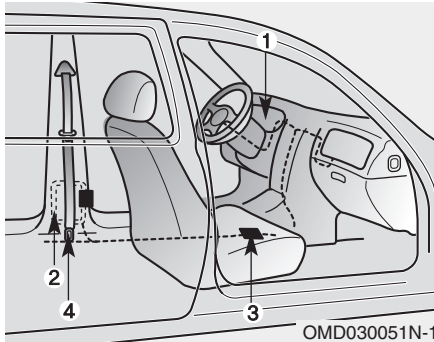

The seat belt pre-tensioner system consists mainly of the following components. Their locations are shown in the illustration:

1. SRS air bag warning light
2. Retractor pre-tensioner assembly
3. SRS control module
4. Emergency fastening device (EFD)

### **⚠ WARNING**

To obtain maximum benefit from a pre-tensioner seat belt:

1. The seatbelt must be worn correctly and adjusted to the proper position. Please read and follow all of the important information and precautions about your vehicle's occupant safety features – including seat belts and air bags – that are provided in this manual.
2. Be sure you and your passengers always wear seat belts properly.

### **\* NOTICE**

- When the pre-tensioner seat belts are activated, a loud noise may be heard and fine dust, which may appear to be smoke, may be visible in the passenger compartment. These are normal operating conditions and are not hazardous.
- Although it is harmless, the fine dust may cause skin irritation and should not be breathed for prolonged periods. Wash all exposed skin areas thoroughly after an accident in which the pre-tensioner seat belts were activated.
- Because the sensor that activates the SRS air bag is connected with the pre-tensioner seat belt, the SRS air bag warning light on the instrument panel will illuminate for approximately 6 seconds after the ignition switch has been turned to the "ON" position, and then it should turn off.

FarmaSOS.com

 **CAUTION**

*If the pre-tensioner seat belt is not working properly, the SRS air bag warning light will illuminate even if there is no malfunction of the SRS air bag. If the SRS air bag warning light does not illuminate when the ignition key is turned to ON, or if it remains illuminated after illuminating for approximately 6 seconds, or if it illuminates while the vehicle is being driven, we recommend that the system be inspected by an authorized HYUNDAI dealer.*

 **WARNING**

- Pre-tensioner seat belts systems are designed to operate only one time. After activation, pre-tensioner seat belts must be replaced. All seat belts, of any type, should always be replaced after they have been worn during a collision.
- The pre-tensioner seat belt assembly mechanisms become hot during activation. Do not touch the pre-tensioner seat belt assemblies for several minutes after they have been activated.
- Do not attempt to inspect or replace the pre-tensioner seat belts yourself. We recommend that the system be inspected by an authorized HYUNDAI dealer.
- Do not attempt to service or repair the pre-tensioner seat belt system in any manner.

(Continued)

(Continued)

- Improper handling of the pre-tensioner seat belt assemblies, and failure to heed the warnings not to strike, modify, inspect, replace, service or repair the pre-tensioner seat belt assemblies may lead to improper operation or inadvertent activation and serious injury.
- Always wear the seat belts when driving or riding in a motor vehicle.
- If the vehicle or pre-tensioner seat belt must be discarded, we recommend that you contact an authorized HYUNDAI dealer.

 **CAUTION**

*Body work on the front area of the vehicle may damage the pre-tensioner seat belt system. Therefore, we recommend that the system be serviced by an authorized HYUNDAI dealer.*

## Seat belt precautions

### **WARNING**

All occupants of the vehicle must wear their seat belts at all times. Seat belts and child restraints reduce the risk of serious or fatal injuries for all occupants in the event of a collision or sudden stop. Without a seat belt, occupants could be shifted too close to a deploying air bag, strike the interior structure or be thrown from the vehicle.

Properly worn seat belts greatly reduce these hazards.

Always follow the precautions about seat belts, air bags and occupant safety contained in this manual.

### *Infant or small child*

You should be aware of the specific requirements in your country. Child and/or infant seats must be properly placed and installed in the rear seat. For more information about the use of these restraints, refer to “Child restraint system” in this section.

### **WARNING**

Every person in your vehicle needs to be properly restrained at all times, including infants and children. Never hold a child in your arms or lap when riding in a vehicle. The violent forces created during a crash will tear the child from your arms and throw the child against the interior. Always use a child restraint appropriate for your child's height and weight.

### **\* NOTICE**

Small children are best protected from injury in an accident when properly restrained in the rear seat by a child restraint system that meets the requirements of the Safety Standards of your country. Before buying any child restraint system, make sure that it has a label certifying that it meets Safety Standards of your country. The restraint must be appropriate for your child's height and weight. Check the label on the child restraint for this information. Refer to “Child restraint system” in this section.

### **Larger children**

Children who are too large for child restraint systems should always occupy the rear seat and use the available lap/shoulder belts. The lap portion should be fastened snug on the hips and as low as possible. Check belt fit periodically. A child's squirming could put the belt out of position. Children are afforded the most safety in the event of an accident when they are restrained by a proper restraint system in the rear seat. If a larger child (over age 12) must be seated in the front seat, the child should be securely restrained by the available lap/shoulder belt and the seat should be placed in the rearmost position. Children age 12 and under should be restrained securely in the rear seat. NEVER place a child age 12 and under in the front seat. NEVER place a rear facing child seat in the front seat of a vehicle.

If the shoulder belt portion slightly touches the child's neck or face, try placing the child closer to the center of the vehicle. If the shoulder belt still touches their face or neck they need to be returned to a child restraint system.

### **⚠ WARNING - Shoulder belts on small children**

- **Never allow a shoulder belt to be in contact with a child's neck or face while the vehicle is in motion.**
- **If seat belts are not properly worn and adjusted on children, there is a risk of death or serious injury.**

تلفن شبانه روزی: ۰۲۱-۸۸۸۶۲۰۸۵

FarmaSOS.com

### **Pregnant women**

The use of a seat belt is recommended for pregnant women to lessen the chance of injury in an accident. When a seat belt is used, the lap belt portion should be placed as low and snugly as possible on the hips, not across the abdomen. For specific recommendations, consult a physician.

### **⚠ WARNING - Pregnant women**

**Pregnant women must never place the lap portion of the safety belt over the area of the abdomen where the fetus is located or above the abdomen where the belt could crush the fetus during an impact.**

### ***Injured person***

A seat belt should be used when an injured person is being transported. When this is necessary, you should consult a physician for recommendations.

### ***One person per belt***

Two people (including children) should never attempt to use a single seat belt. This could increase the severity of injuries in case of an accident.

### ***Do not lie down***

To reduce the chance of injuries in the event of an accident and to achieve maximum effectiveness of the restraint system, all passengers should be sitting up and the front seats should be in an upright position when the car is moving. A seat belt cannot provide proper protection if the person is lying down in the rear seat or if the front seat is in a reclined position.

### **⚠ WARNING**

**Riding with a reclined seatback increases your chance of serious or fatal injuries in the event of a collision or sudden stop. The protection of your restraint system (seat belts and air bags) is greatly reduced by reclining your seat. Seat belts must be snug against your hips and chest to work properly. The more the seatback is reclined, the greater the chance that an occupant's hips will slide under the lap belt causing serious internal injuries or the occupant's neck could strike the shoulder belt. Drivers and passengers should always sit well back in their seats, properly belted, and with the seatbacks upright.**

### **Care of seat belts**

Seat belt systems should never be disassembled or modified. In addition, care should be taken to assure that seat belts and belt hardware are not damaged by seat hinges, doors or other abuse.

### **⚠ WARNING**

**When you return the rear seatback to its upright position after the rear seatback was folded down, be careful not to damage the seat belt webbing or buckle. Be sure that the webbing or buckle does not get caught or pinched in the rear seat. A seat belt with damaged webbing or buckle will not be as strong and could possibly fail during a collision or sudden stop, resulting in serious injury.**

### ***Periodic inspection***

It is recommended that all seat belts be inspected periodically for wear or damage of any kind. Any damaged parts should be replaced as soon as possible.

### ***Keep belts clean and dry***

Seat belts should be kept clean and dry. If belts become dirty, they can be cleaned by using a mild soap solution and warm water. Bleach, dye, strong detergents or abrasives should not be used because they may damage and weaken the fabric.

### ***When to replace seat belts***

Entire in-use seat belt assembly or assemblies should be replaced if the vehicle has been involved in an accident. This should be done even if no damage is visible. We recommend that you consult an authorized HYUNDAI dealer.

امداد خودرو فارما

تلفن شبانه روزی: ۰۲۱-۸۸۸۶۲۰۸۵

FarmaSOS.com

## CHILD RESTRAINT SYSTEM (IF EQUIPPED)

Children riding in the car should sit in the rear seat and must always be properly restrained to minimize the risk of injury in an accident, sudden stop or sudden maneuver. According to accident statistics, children are safer when properly restrained in the rear seats than in the front seat. Larger children not in a child restraint should use one of the seat belts provided.

You should be aware of the specific requirements in your country. Child and/or infant safety seats must be properly placed and installed in the rear seat. You must use a commercially available child restraint system that meets the requirements of the Safety Standards of your country. Child restraint systems are designed to be secured in vehicle seats by lap belts or the lap belt portion of a lap/shoulder belt, or by a tether anchor and/or ISOFIX anchors (if equipped).

Children could be injured or killed in a crash if their restraints are not properly secured.

For small children and babies, a child seat or infant seat must be used. Before buying a particular child restraint system, make sure it fits your car seat and seat belts, and fits your child. Follow all the instructions provided by the manufacturer when installing the child restraint system.

The rear seats have to be moved to their rearmost position when using Child Restraint System.

### **⚠ WARNING**

- **A child restraint system must be placed in the rear seat. Never install a child or infant seat on the front passenger's seat. Should an accident occur and cause the passenger side air bag to deploy, it could severely injure or kill an infant or child seated in an infant or child seat. Thus only use a child restraint in the rear seat of your vehicle.**

**(Continued)**

### **(Continued)**

- **A seat belt or child restraint system can become very hot if it is left in a closed vehicle on a sunny day, even if the outside temperature does not feel hot. Be sure to check the seat cover and buckles before placing a child there.**
- **When the child restraint system is not in use, store it in the luggage area or fasten it with a seat belt so that it will not be thrown forward in the case of a sudden stop or an accident.**
- **Children may be seriously injured or killed by an inflating air bag. All children, even those too large for child restraints, must ride in the rear seat.**



**⚠ WARNING**

To reduce a risk of serious or fatal injuries:

- Children of all ages are safer when restrained in the rear seat. A child riding in the front passenger seat can be forcefully struck by an inflating air bag resulting in serious or fatal injuries.
- Always follow the instructions for installation and use of the child restraint maker.
- Always make sure the child seat is secured properly in the car and your child is securely restrained in the child seat.
- Never hold a child in your arms or lap when riding in a vehicle. The violent forces created during a crash will tear the child from your arms and throw the child against the car's interior.

(Continued)

(Continued)

- Never put a seat belt over yourself and a child. During a crash, the belt could press deep into the child causing serious internal injuries.
- Never leave children unattended in a vehicle – not even for a short time. The car can heat up very quickly, resulting in serious injuries to children inside. Even very young children may inadvertently cause the vehicle to move, entangle themselves in the windows, or lock themselves or others inside the vehicle.
- Never allow two children, or any two persons, to use the same seat belt.
- Children often squirm and reposition themselves improperly. Never let a child ride with the shoulder belt under their arm or behind their back. Always properly position and secure children in the rear seat.

(Continued)

(Continued)

- Never allow a child to stand-up or kneel on the seat or floorboard of a moving vehicle. During a collision or sudden stop, the child can be violently thrown against the vehicle's interior, resulting in serious injury.
- Never use an infant carrier or a child safety seat that "hooks" over a seatback, it may not provide adequate security in an accident.
- Seat belts can become very hot, especially when the car is parked in direct sunlight. Always check seat belt buckles before fastening them over a child.
- After an accident, we recommend that the system be checked by an authorized HYUNDAI dealer.

(Continued)

**(Continued)**

- If there is not enough space to place the child restraint system because of the driver's seat, install the child restraint system in the rear right seat.

**Using a child restraint system**

Rearward-facing child restraint system



Forward-facing child restraint system



For small children and babies, the use of a child seat or infant seat is required. This child seat or infant seat should be of appropriate size for the child and should be installed in accordance with the manufacturer's instructions.

For safety reasons, we recommend that the child restraint system be used in the rear seats.

**⚠ WARNING**

**Never place a rear-facing child restraint in the front passenger seat, because of the danger that an inflating passenger-side air bag could impact the rear-facing child restraint and kill the child.**

**⚠ WARNING - Child seat installation**

- Before installing the child restraint system, read the instructions supplied by the child restraint system manufacturer.
- If the seat belt does not operate as described in this section, we recommend that the system be checked by an authorized HYUNDAI dealer.
- Failure to observe this manual's instructions regarding child restraint system and the instructions provided with the child restraint system could increase the chance and/or severity of injury in an accident.

**Installing a child restraint system by lap/shoulder belt**

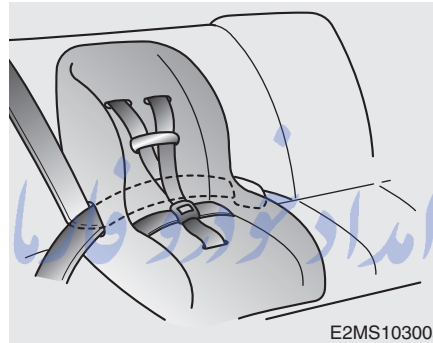

E2MS103005

To install a child restraint system on the outboard or center rear seats, do the following:

1. Place the child restraint system in the seat and route the lap/shoulder belt around or through the restraint, following the restraint manufacturer's instructions. Be sure the seat belt webbing is not twisted.

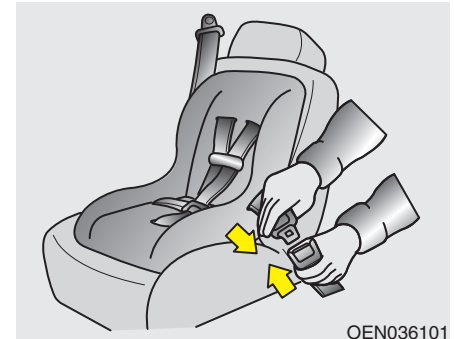

OEN036101

2. Fasten the lap/shoulder belt latch into the buckle. Listen for the distinct "click" sound.

*Position the release button so that it is easy to access in case of an emergency.*



3. Buckle the seat belt and allow the seat belt to take up any slack. After installation of the child restraint system, try to move it in all directions to be sure the child restraint system is securely installed.

If you need to tighten the belt, pull more webbing toward the retractor. When you unbuckle the seat belt and allow it to retract, the retractor will automatically revert back to its normal seated passenger emergency locking usage condition.

### **Child Seat Restraint Suitability For Seat Position using the Seat Belt - For Europe**

Use child safety seats that have been officially approved and are appropriate for your children. When using the child safety seats, refer to the following table.

Mass Group	Seating Position			
	Front Passenger	2nd outboard	2nd Center	3rd outboard (if equipped)
0 : Up to 10kg (0-9 months)	U	U	U	U*
0 + : Up to 13kg (0 - 2 years)	U	U	U	U*
I : 9 to 18kg (9 months - 4 years)	U	U	U	U*
II : 15 to 25kg	U	U	U	U*
II & III : 22 to 36kg	U	U	U	U*

U : suitable for "universal" category restraints approved for use in this mass group

U\* : suitable for "universal" category restraints approved for use in this mass group.

But 2nd seat should be adjusted to the foremost positions.

**Securing a child restraint seat with “Tether Anchor” system (if equipped)**

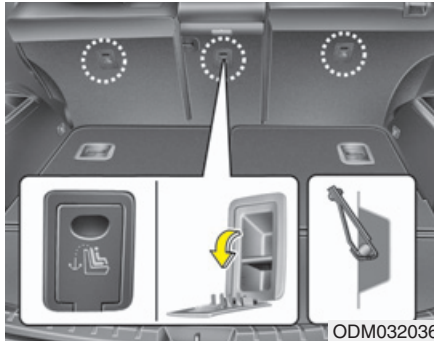

Child restraint hook holders are located on the rear of the seat back.

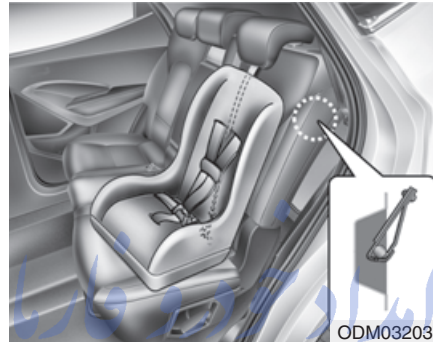

1. Route the child restraint seat tether strap over the seatback.

For vehicles with adjustable headrests, route the tether strap under the headrest and between the headrest posts, otherwise route the tether strap over the top of the seatback.

2. Connect the tether strap hook to the appropriate child restraint hook holder and tighten to secure the seat.

**⚠ WARNING**

A child can be seriously injured or killed in a collision if the child restraint is not properly anchored to the car and the child is not properly restrained in the child restraint. Always follow the child seat manufacturer's instructions for installation and use.

**⚠ WARNING - Tether strap**

Never mount more than one child restraint to a single tether anchor or to a single lower anchorage point. The increased load caused by multiple seats may cause the tether or anchorage points to break, causing serious injury or death.

**⚠ WARNING - Child restraint check**

Check that the child restraint system is secure by pushing and pulling it in different directions. Incorrectly fitted child restraints may swing, twist, tip or separate causing death or serious injury.

**⚠ WARNING - Child restraint anchorage**

- Child restraint anchorages are designed to withstand only those loads imposed by correctly fitted child restraints. Under no circumstances are they to be used for adult seat belts or harnesses or for attaching other items or equipment to the vehicle.
- The tether strap may not work properly if attached somewhere other than the correct tether anchor.

**Securing a child restraint system with “ISOFIX” system and “Tether Anchorage” system (if equipped)**

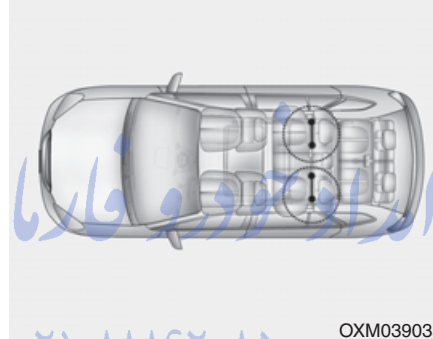

OXM039035

ISOFIX is a standardised method of fitting child seats that eliminates the need to use the standard adult seat belt to secure the seat in the vehicle. This enables a much more secure and positive location with the added benefit of easier and quicker installation.

An ISOFIX-seat can only be installed if it has vehicle-specific approval in accordance with the requirements of ECE-R44.

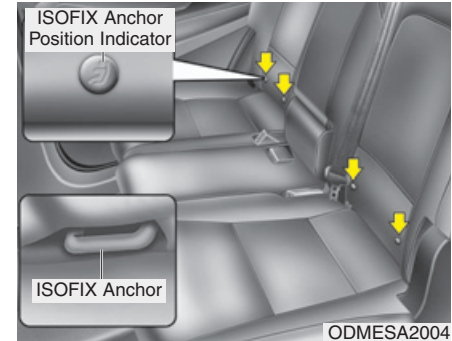

There are ISOFIX symbols located on the lower portion of each side of the rear seatbacks. These symbols indicate the position of the lower anchors for child restraints so equipped.

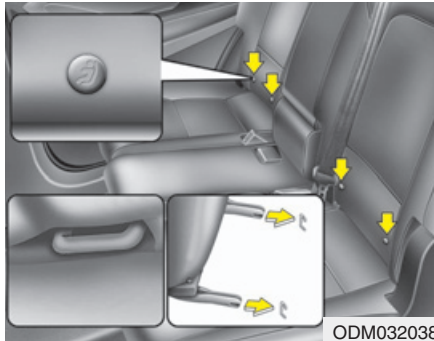

Both rear outboard seats are equipped with a pair of ISOFIX anchorages as well as a corresponding top tether anchorage on the back side of the back rest. The ISOFIX anchorages are located between seat cushion and back rest, marked with the ISOFIX icon.

For installation, CRS ISOFIX connectors have to engage with the vehicles ISOFIX anchorages (listen for a CLICK, check potential visual indicators on the CRS and cross-check by pulling).

CRS with universal approval to ECE-R 44 need to be fixed additionally with a top tether strap connected to the corresponding top tether anchorage point in the back rest.

The installing and the use of a child-seat has to be done according to the installing-manual, which is added to the ISOFIX-seat.

### **⚠ WARNING**

**Install the child restraint seat fully rearward against the seat-back with the seatback reclined two positions from the most upright latched position.**

[FarmaSOS.com](http://FarmaSOS.com)

### **⚠ WARNING**

- When using the vehicle's "ISOFIX" system to install a child restraint system in the rear seat, all unused vehicle rear seat belt metal latch plates or tabs must be latched securely in their seat belt buckles and the seat belt webbing must be retracted behind the child restraint to prevent the child from reaching and taking hold of unretracted seat belts. Unlatched metal latch plates or tabs may allow the child to reach the unretracted seat belts which may result in strangulation and a serious injury or death to the child in the child restraint.
- Do not place anything around the lower anchors. Also make sure that the seat belt is not caught in the lower anchors.

**To secure the child restraint seat**

1. To engage the child restraint seat to the ISOFIX anchor, insert the child restraint seat latch into the ISOFIX anchor. Listen for the audible “click” sound.

**⚠ CAUTION**

*Do not allow the rear seat belt webbing to get scratched or pinched by the ISOFIX-seat latch and ISOFIX anchor during installation.*

2. Connect the tether strap hook to the child restraint hook holder and tighten to secure the seat. (Refer to the previous page.)

**⚠ WARNING**

- Do not install a child restraint seat at the center of the rear seat using the vehicle's ISOFIX anchors. The ISOFIX anchors are only provided for the left and right outboard rear seating positions. Do not misuse the ISOFIX anchors by attempting to attach a child restraint seat in the middle of the rear seat to the ISOFIX anchors.

In a crash, the child restraint seat ISOFIX attachments may not be strong enough to secure the child restraint seat properly in the center of the rear seat and may break, causing serious injury or death.

(Continued)

(Continued)

- Do not mount more than one child restraint to a child restraint lower anchorage point. The improper increased load may cause the anchorage points or tether anchor to break, causing serious injury or death.
- Attach the ISOFIX or ISOFIX-compatible child restraint seat only to the appropriate locations shown in the illustration.
- Always follow the installation and use instructions provided by the manufacturer of the child restraint.



### Child seat restraint suitability for vehicle ISOFIX positions - For Europe

Mass Group	Size Class	Fixture	Vehicle ISOFIX Position					
			Front Passenger	2nd Outboard	2nd Center	3rd Outboard	3rd Center	Other Sites
Carrycot	F	ISO/L1	x	x	x	x	x	x
	G	ISO/L2	x	x	x	x	x	x
0: up to 10kg	E	ISO/R1	x	IUF	x	x	x	x
0+: up to 13kg	E	ISO/R1	x	IUF	x	x	x	x
	D	ISO/R2	x	IUF	x	x	x	x
	C	ISO/R3	x	IUF	x	x	x	x
I: 9 to 18kg	D	ISO/R2	x	IUF	x	x	x	x
	C	ISO/R3	x	IUF	x	x	x	x
	B	ISO/F2	x	IUF	x	x	x	x
	B1	ISO/F2X	x	IUF	x	x	x	x
	A	ISO/F3	x	IUF	x	x	x	x

IUF = Suitable for ISOFIX forward child restraints systems of universal category approved for use in the mass group.

X = ISOFIX position not suitable for ISOFIX child restraint system in this mass group and/or this size class.

\* Both ISO/R2 and ISO/R3 are able to be set up only at the foremost position of the passenger seat.

\* ISOFIX child restraint system size classes and fixtures

A - ISO/F3: Full-Height Forward-Facing toddler CRS (height 720mm)

B - ISO/F2: Reduced-Height Forward-Facing toddler CRS (height 650mm)

B1 - ISO/F2X: Reduced-Height Second Version Back Surface Shape Forward-Facing toddler CRS (height 650mm)

C - ISO/R3: Full-Size Rearward-Facing toddler CRS

D - ISO/R2: Reduced-Size Rearward-Facing toddler CRS

E - ISO/R1: Infant-Size Rearward-Facing CRS

F - ISO/L1: Left Lateral Facing position CRS (carry-cot)

G - ISO/L2: Right Lateral Facing position CRS (carry-cot)

**Recommended child restraint systems - For Europe**

Mass Group	Name Part. No.	Manufacturer	Type of Fixation	ECE-R44 Approval No.
Group 0-1 (0-18kg)	Baby Safe Plus Part. No. E8945-66001 Part. No. E8945-66029	Britax Römer	Rearward facing with ISOFIX Base	E1 04301146
Group 1 (9-18kg)	Duo Plus Part. No. E8945-66011	Britax Römer	Forward facing with vehicle ISOFIX lower anchorage + Top Tether	E1 04301133

**CRS Manufacturer information**Britax Römer <http://www.britax.com>

تلفن شبانه روزی: ۰۲۱-۸۸۸۶۲۰۸۵

FarmaSOS.com

## AIR BAG - SUPPLEMENTAL RESTRAINT SYSTEM (IF EQUIPPED)

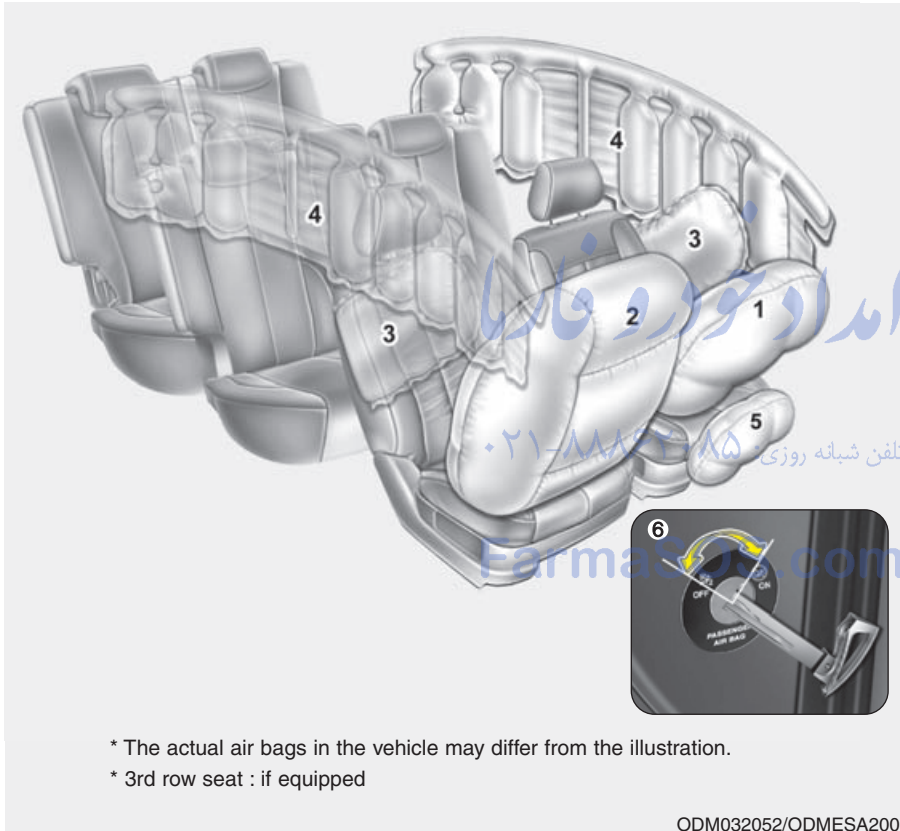

\* The actual air bags in the vehicle may differ from the illustration.

\* 3rd row seat : if equipped

ODM032052/ODMESA2008

- (1) Driver's front air bag
  - (2) Passenger's front air bag\*
  - (3) Side impact air bag\*
  - (4) Curtain air bag\*
  - (5) Driver's knee air bag\*
  - (6) Passenger's front air bag ON/OFF switch\*
- \* : if equipped

### **⚠ WARNING**

- Even in vehicles with air bags, you and your passengers must always wear the safety belts provided in order to minimize the risk and severity of injury in the event of a collision or rollover.
- SRS and pretensioners contain explosive chemicals. If scraping a vehicle without removing SRS and pretensioners from a vehicle, it may cause fire. Before scraping a vehicle, we recommend that you contact an authorized HYUNDAI dealer.

(Continued)

**(Continued)**

- **Keep the SRS parts and wirings away from water or any liquid. If the SRS components are inoperative due to exposure to water or liquids, it may cause fire or severe injury.**

**How does the air bag system operate**

- Air bags are activated (able to inflate if necessary) only when the ignition switch is turned to the ON or START position.
- Air bags inflate instantly in the event of serious frontal or side collision (if equipped with side impact air bag or curtain air bag) in order to help protect the occupants from serious physical injury.

**\* NOTICE - if equipped with rollover sensor**

**Also, the air bags inflate instantly in the event of a rollover (if equipped with a side airbag or curtain air bag) in order to help protect the occupants from serious physical injury.**

- There is no single speed at which the air bags will inflate.

Generally, air bags are designed to inflate based upon the severity of a collision and its direction. These two factors determine whether the sensors produce an electronic deployment/inflation signal.

- Air bag deployment depends on a number of factors including vehicle speed, angles of impact and the density and stiffness of the vehicles or objects which your vehicle hits in the collision. The determining factors are not limited to those mentioned above.
- The front air bags will completely inflate and deflate in an instant.

It is virtually impossible for you to see the air bags inflate during an accident. It is much more likely that you will simply see the deflated air bags hanging out of their storage compartments after the collision.

- In order to help provide protection in a severe collision, the air bags must inflate rapidly. The speed of air bag inflation is a consequence of extremely short time in which a collision occurs and the need to get the air bag between the occupant and the vehicle structures before the occupant impacts those structures. This speed of inflation reduces the risk of serious or life-threatening injuries in a severe collision and is thus a necessary part of air bag design.

However, air bag inflation can also cause injuries which can include facial abrasions, bruises and broken bones because the inflation speed also causes the air bags to expand with a great deal of force.

- **There are even circumstances under which contact with the steering wheel air bag can cause fatal injuries, especially if the occupant is positioned excessively close to the steering wheel.**

**⚠ WARNING**

- To avoid severe personal injury or death caused by deploying air bags in a collision, the driver should sit as far back from the steering wheel air bag as possible (at least 250 mm (10 inches) away). The front passenger should always move their seat as far back as possible and sit back in their seat.
- Air bag inflates instantly in an event of a collision, passengers may be injured by the air bag expansion force if they are not in a proper position.
- Air bag inflation may cause injuries including facial or bodily abrasions, injuries from broken glasses or burns.

**Noise and smoke**

When the air bags inflate, they make a loud noise and they leave smoke and powder in the air inside of the vehicle. This is normal and is a result of the ignition of the air bag inflator. After the air bag inflates, you may feel substantial discomfort in breathing due to the contact of your chest with both the seat belt and the air bag, as well as from breathing the smoke and powder. **Open your doors and/or windows as soon as possible after impact in order to reduce discomfort and prevent prolonged exposure to the smoke and powder.**

Though smoke and powder are non-toxic, it may cause irritation to the skin (eyes, nose and throat, etc.). If this is the case, wash and rinse with cold water immediately and consult the doctor if the symptom persists.

**⚠ WARNING**

**When the air bags deploy, the air bag related parts in the steering wheel, instrument panel and/or in both sides of the roof rails above the front and rear doors are very hot. To prevent injury, do not touch the air bag storage areas internal components immediately after an air bag has inflated.**

**Do not install a child restraint on the front passenger seat**

■ Type A



1JBH3051

■ Type B



OYDESA2042

■ Type C

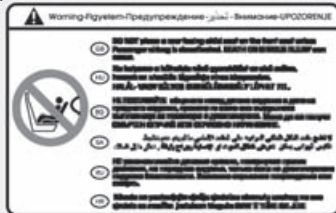

OLM034310

Never place a rear-facing child restraint in the front passenger's seat. If the air bag deploys, it would impact the rear-facing child restraint, causing serious or fatal injury. In addition, do not place front-facing child restraints in the front passenger's seat either. If the front passenger air bag inflates, it would cause serious or fatal injuries to the child. If your vehicle is equipped with the passenger's front air bag ON/OFF switch, you can activate or deactivate the front passenger's air bag when necessary.

تلفن شبانه روزی: ۰۲۱-۸۸۶۶۲۰۸۵

FarmaSOS.com

**⚠ WARNING**

- **NEVER** use a rearward facing child restraint on a seat protected by an **ACTIVE AIRBAG** in front of it, **DEATH** or **SERIOUS INJURY** to the **CHILD** can occur.
- Never put a child restraint in the front passenger's seat. If the front passenger air bag inflates, it would cause serious or fatal injuries.
- When children are seated in the rear outboard seats of vehicle equipped with side and/or curtain air bags, be sure to install the child restraint system as far away from the door side as possible, and securely lock the child restraint system in position. Inflation of side and/or curtain air bags could cause serious injury or death to an infant or child.

### Air bag warning and indicator

#### Air bag warning light



The purpose of the air bag warning light in your instrument panel is to alert you of a potential problem with your air bag - Supplemental Restraint System (SRS).

When the ignition switch is turned ON, the warning light should illuminate for approximately 6 seconds, then go off.

Have the system checked if:

- The light does not turn on briefly when you turn the ignition ON.
- The light stays on after illuminating for approximately 6 seconds.
- The light comes on while the vehicle is in motion.
- The light blinks when the ignition switch is in ON position.

تلفن شبانه روزی: ۰۲۱-۸۸۸۶۲۰۸۵

[FarmaSOS.com](http://FarmaSOS.com)

### Passenger's front air bag ON indicator (if equipped)



The passenger's front air bag ON indicator illuminates for approximately 4 seconds after the ignition switch is turned to the ON position.

The passenger's front air bag ON indicator also comes on when the passenger's front air bag ON/OFF switch is set to the ON position and goes off after approximately 60 seconds.

**Passenger's front air bag  
OFF indicator (if equipped)**

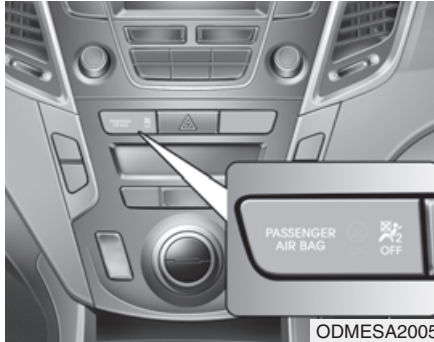

The passenger's front air bag OFF indicator illuminates for about 4 seconds after the ignition switch is turned to the ON position.

The passenger's front air bag OFF indicator also comes on when the passenger's front air bag ON/OFF switch is set to the OFF position and goes off when the passenger's front air bag ON/OFF switch is set to the ON position.

**⚠ CAUTION**

*If the passenger's front air bag ON/OFF switch malfunctions, the passenger's front air bag OFF indicator will not illuminate (The passenger's front air bag ON indicator comes on and goes off after approximately 60 seconds) and the passenger's front air bag will inflate in a frontal impact even if the passenger's front air bag ON/OFF switch is set to the OFF position.*

*If this occurs, we recommend that the passenger's front air bag ON/OFF switch and the SRS air bag system be inspected by an authorized HYUNDAI dealer.*

FarmaSOS.com

**SRS components and functions**

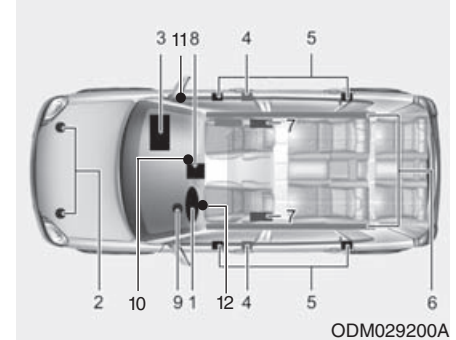

The SRS consists of the following components:

1. Driver's front air bag module
2. Front impact sensors
3. Passenger's front air bag module\*
4. Pretensioner seatbelt systems\*
5. Side impact sensors\*
6. Curtain air bag modules\*
7. Side air bag modules\*
8. SRS control module (SRSCM)/ Rollover sensor\*
9. Air bag warning light



10. Passenger's front air bag OFF indicator (front passenger's seat only)\*
11. Passenger's front air bag ON/OFF switch\*
12. Driver's knee air bag module\*  
\* : if equipped

The SRSCM continually monitors all elements while the ignition switch is ON to determine if a frontal or near-frontal impact is severe enough to require air bag deployment or pretensioner seat belt deployment.

The SRS air bag warning light on the instrument panel will illuminate for about 6 seconds after the ignition switch is turned to the ON position, after which the air bag warning light should go out.

### **⚠ WARNING**

**If any of the following conditions occurs, this indicates a malfunction of the SRS. We recommend that the system be inspected by an authorized HYUNDAI dealer.**

- **The light does not turn on briefly when you turn the ignition ON.**
- **The light stays on after illuminating for approximately 6 seconds.**
- **The light comes on while the vehicle is in motion.**
- **The light blinks when the ignition switch is in ON position.**

Driver's front air bag (1)



The front air bag modules are located both in the center of the steering wheel, in the front passenger's panel above the glove box and/or in the driver's side knee bolster. When the SRSCM detects a sufficiently severe impact to the front of the vehicle, it will automatically deploy the front air bags.

Driver's front air bag (2)



Upon deployment, tear seams molded directly into the pad covers will separate under pressure from the expansion of the air bags. Further opening of the covers then allows full inflation of the air bags.

Driver's front air bag (3)

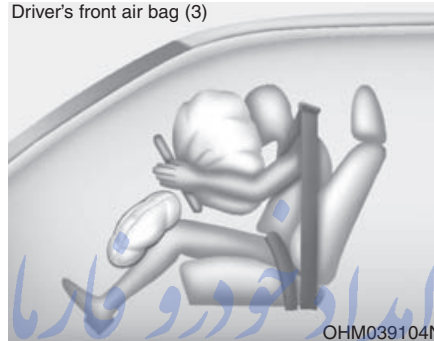

A fully inflated air bag, in combination with a properly worn seat belt, slows the driver's or the passenger's forward motion, reducing the risk of head and chest injury.

After complete inflation, the air bag immediately starts deflating, enabling the driver to maintain forward visibility and the ability to steer or operate other controls.

Passenger's front air bag

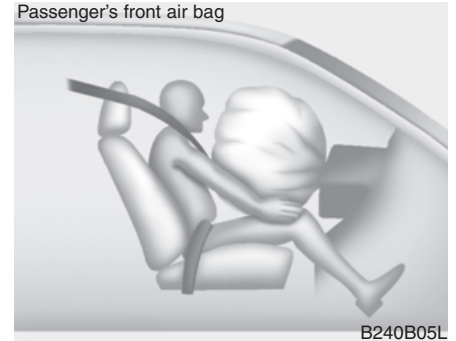

**⚠ WARNING**

- Do not install or place any accessories (drink holder, CD holder, sticker, etc.) on the front passenger's panel above the glove box in a vehicle with a passenger's air bag. Such objects may become dangerous projectiles and cause injury if the passenger's air bag inflates.

(Continued)

(Continued)

- When installing a container of liquid air freshener inside the vehicle, do not place it near the instrument cluster nor on the instrument panel surface. It may become dangerous projectiles and cause injury if the passenger's air bag inflates.

**⚠ WARNING**

- If an air bag deploys, there may be a loud noise followed by a fine dust released in the vehicle. These conditions are normal and are not hazardous - the air bags are packed in this fine powder. The dust generated during air bag deployment may cause skin or eye irritation as well as aggravate asthma for some persons. Always wash all exposed skin areas thoroughly with lukewarm water and a mild soap after an accident in which the air bags were deployed.

(Continued)

(Continued)

- The SRS can function only when the ignition key is in the "ON" position. If the SRS air bag warning light does not illuminate, or continuously remains on after illuminating for about 6 seconds when the ignition key is turned to the ON position, or after the engine is started, comes on while driving, the SRS is not working properly.

If this occurs, we recommend that the system be inspected by an authorized HYUNDAI dealer.

- Before you replace a fuse or disconnect a battery terminal, turn the ignition switch to the LOCK position and remove the ignition key. Never remove or replace the air bag related fuse(s) when the ignition switch is in the ON position. Failure to heed this warning will cause the SRS air bag warning light to illuminate.

**Driver's and passenger's front air bag (if equipped)**

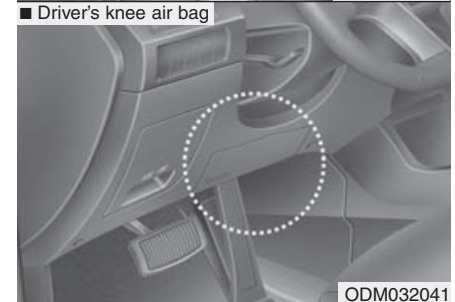

Your vehicle is equipped with a Supplemental Restraint (Air Bag) System and lap/shoulder belts at both the driver and passenger seating positions.

The indications of the system's presence are the letters "AIR BAG" embossed on the air bag pad cover in the steering wheel and/or on the cover of the driver's side knee bolster located below the steering wheel and the passenger's side front panel pad above the glove box.

The SRS consists of air bags installed under the pad covers in the center of the steering wheel, in the knee bolster below the steering wheel column and the passenger's side front panel above the glove box.



The purpose of the SRS is to provide the vehicle's driver and/or the front passenger with additional protection than that offered by the seat belt system alone in case of a frontal impact of sufficient severity.

[FarmaSOS.com](http://FarmaSOS.com)

**⚠ WARNING**

**Always use seat belts and child restraints – every trip, every time, everyone! Air bags inflate with considerable force and in the blink of an eye. Seat belts help keep occupants in proper position to obtain maximum benefit from the air bag. Even with air bags, improperly and unbelted occupants can be severely injured when the air bag inflates. Always follow the precautions about seat belts, air bags and occupant safety contained in this manual.**

**To reduce the chance of serious or fatal injuries and receive the maximum safety benefit from your restraint system:**

- **Never place a child in any child or booster seat in the front seat.**
- **ABC – Always Buckle Children in the back seat. It is the safest place for children of any age to ride.**

**(Continued)**

### (Continued)

- Front and side air bags can injure occupants improperly positioned in the front seats.
- Move your seat as far back as practical from the front air bags, while still maintaining control of the vehicle.
- You and your passengers should never sit or lean unnecessarily close to the air bags. Improperly positioned drivers and passengers can be severely injured by inflating air bags.
- Never lean against the door or center console – always sit in an upright position.
- Do not allow a passenger to ride in the front seat when the passenger's front air bag OFF indicator is illuminated, because the air bag will not deploy in the event of a moderate or severe frontal crash.

(Continued)

### (Continued)

- No objects should be placed over or near the air bag modules on the steering wheel, instrument panel, and the front passenger's panel above the glove box, because any such object could cause harm if the vehicle is in a crash severe enough to cause the air bags to deploy.
- Do not tamper with or disconnect SRS wiring or other components of the SRS system. Doing so could result in injury, due to accidental deployment of the air bags or by rendering the SRS inoperative.
- If the SRS air bag warning light remains illuminated while the vehicle is being driven, we recommend that the system be inspected by an authorized HYUNDAI dealer.
- Air bags can only be used once – we recommend that the system be replaced by an authorized HYUNDAI dealer.

(Continued)

### (Continued)

- The SRS is designed to deploy the front air bags only when an impact is sufficiently severe and when the impact angle is less than 30° from the forward longitudinal axis of the vehicle. Additionally, the air bags will only deploy once. Seat belts must be worn at all times.
- Front air bags are not intended to deploy in side-impact, rear-impact or rollover crashes. In addition, front air bags will not deploy in frontal crashes below the deployment threshold.
- A child restraint system must never be placed in the front seat. The infant or child could be severely injured or killed by an air bag deployment in case of an accident.

(Continued)

(Continued)

- Children age 12 and under must always be properly restrained in the rear seat. Never allow children to ride in the front passenger seat. If a child over 12 must be seated in the front seat, he or she must be properly belted and the seat should be moved as far back as possible.
- For maximum safety protection in all types of crashes, all occupants including the driver should always wear their seat belts whether or not an air bag is also provided at their seating position to minimize the risk of severe injury or death in the event of a crash. Do not sit or lean unnecessarily close to the air bag while the vehicle is in motion.

(Continued)

(Continued)

- Sitting improperly or out of position can result in serious or fatal injury in a crash. All occupants should sit upright with the seat back in an upright position, centered on the seat cushion with their seat belt on, legs comfortably extended and their feet on the floor until the vehicle is parked and the ignition key is removed.
- The SRS air bag system must deploy very rapidly to provide protection in a crash. If an occupant is out of position because of not wearing a seat belt, the air bag may forcefully contact the occupant causing serious or fatal injuries.

*Passenger's front air bag ON/OFF switch (if equipped)*



The passenger's front air bag can be deactivated by the passenger's front air bag ON/OFF switch if a child restraint is installed on the front passenger's seat or if the front passenger's seat is unoccupied by a person. To ensure the safety of your child, the passenger's front air bag must be deactivated when it should be necessary to install a rearward facing child seat on the front passenger seat in exceptional circumstances.

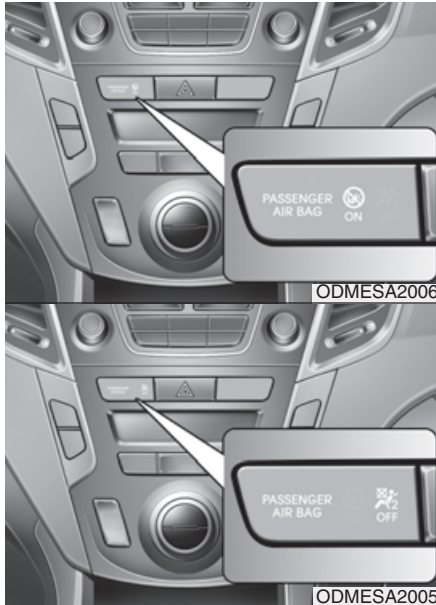

**To deactivate or reactivate the passenger's front air bag:**

To deactivate the passenger's front air bag, insert the mechanical key into the passenger's front air bag ON/OFF switch and turn it to the OFF position.

The passenger's front air bag OFF indicator (⊗) will illuminate and stay on until the passenger's front air bag is reactivated.

To reactivate the passenger's front air bag, insert the mechanical key into the passenger's front air bag ON/OFF switch and turn it to the ON position. The passenger's front air bag OFF indicator will go out and the passenger's front air bag ON indicator (⊗) will illuminate for approximately 60 seconds.

### **⚠ WARNING**

On some models, the front air bag ON/OFF switch could turn by using a similar small rigid device. Always check the status of the front air bag ON/OFF switch and passenger's front air bag ON/OFF indicator.

### **\* NOTICE**

- When the passenger's front air bag ON/OFF switch is set to the ON position, the passenger's front air bag is activated and child or infant seat should not be installed on the front passenger seat.
- When the passenger's front air bag ON/OFF switch is set to the OFF position, the passenger's front air bag is deactivated.

### **⚠ CAUTION**

- *If the passenger's front air bag ON/OFF switch is not working properly, the air bag warning light (⊗) on the instrument panel will illuminate.*

*(Continued)*

**(Continued)**

**And, the passenger's front air bag OFF indicator (OFF) will not illuminate (The passenger's front air bag ON indicator comes on and goes off after approximately 60 seconds), the SRS Control Module reactivates the passenger's front air bag and the passenger's front air bag will inflate in frontal impact crashes even if the passenger's front air bag ON/OFF switch is set to the OFF position.**

**If this occurs, we recommend that the system be inspected by an authorized HYUNDAI dealer.**

- **If the SRS air bag warning light blinks or does not illuminate when the ignition switch is turned to the ON position, or if it illuminates while the vehicle is being driven, we recommend that the system be inspected by an authorized HYUNDAI dealer.**

### **⚠ WARNING**

- **The driver is responsible for the proper position of the passenger's front air bag ON/OFF switch.**
- **Deactivate the passenger's front air bag only when the ignition switch is switched off, or the malfunction may occur in the SRS Control Module. And there may be a danger that the driver's and/or front passenger's and/or side and curtain air bag may fail to trigger, or not trigger correctly during a collision.**
- **Never install a rearward facing child seat on the front passenger's seat unless the passenger's front air bag has been deactivated. The infant or child could be severely injured or killed by an air bag deployment in case of an accident.**

**(Continued)**

**(Continued)**

- **Even though your vehicle is equipped with the passenger's front air bag ON/OFF switch, do not install a child restraint system in the front passenger's seat. A child restraint system must never be placed in the front seat. Children who are too large for child restraint systems should always occupy the rear seat and use the available lap/shoulder belts. Children are afforded the most safety in the event of an accident when they are restrained by a proper restraint system in the rear seat.**
- **As soon as the child seat is no longer needed on the front passenger's seat, reactivate the front passenger's air bag.**



### Side impact air bag (if equipped)

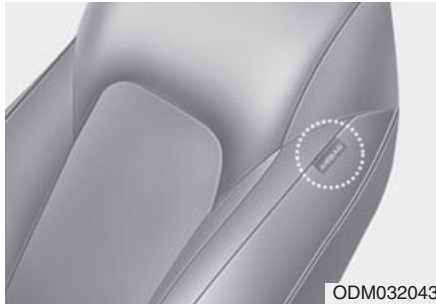

\* The actual air bags in the vehicle may differ from the illustration.

Your vehicle is equipped with a side impact air bag in each front seat.

The purpose of the air bag is to provide the vehicle's driver and/or the front passenger with additional protection than that offered by the seat belt alone.

The side impact air bags are designed to deploy only during certain side-impact collisions, depending on the crash severity, angle, speed and point of impact. The side air bags are not designed to deploy in all side impact situations.

The side impact air bags do not only deploy on the side of the impact but also on the opposite side.

#### **⚠ WARNING**

**Do not allow the passengers to lean their heads or bodies onto doors, put their arms on the doors, stretch their arms out of the window, or place objects between the doors and passengers when they are seated on seats equipped with side and/or curtain air bags.**

#### **⚠ WARNING**

- **The side impact air bag is supplemental to the driver's and the passenger's seat belt systems and is not a substitute for them. Therefore your seat belts must be worn at all times while the vehicle is in motion. The air bags deploy only in certain side impact or rollover\* conditions severe enough to cause significant injury to the vehicle occupants.**
- **For best protection from the side impact air bag system and to avoid being injured by the deploying side impact air bag, both front seat occupants should sit in an upright position with the seat belt properly fastened. The driver's hands should be placed on the steering wheel at the 9:00 and 3:00 positions. The passenger's arms and hands should be placed on their laps.**

**(Continued)**

(Continued)

- Do not use any accessory seat covers.
- Use of seat covers could reduce or prevent the effectiveness of the system.
- Do not install any accessories on the side or near the side impact air bag.
- Do not place any objects over the air bag or between the air bag and yourself.
- Do not place any objects (an umbrella, bag, etc.) between the front door and the front seat. Such objects may become dangerous projectiles and cause injury if the supplemental side impact air bag inflates.
- To prevent unexpected deployment of the side impact air bag that may result in personal injury, avoid impact to the side impact sensor when the ignition key is on.

(Continued)

(Continued)

- If the seat or seat cover is damaged, we recommend that the system be serviced by an authorized HYUNDAI dealer.

\*: Only vehicle is equipped with rollover sensor.

امداد خودرو فارما

تلفن شبانه روزی: ۰۲۱-۸۸۸۶۲۰۸۵

FarmaSOS.com

## Curtain air bag (if equipped)

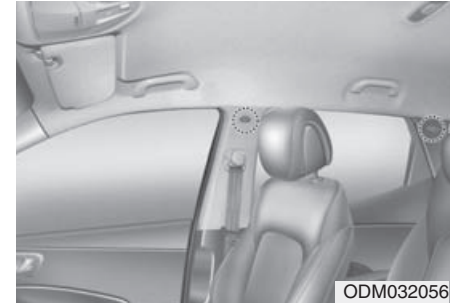

ODM032056



OHM032072

\* The actual air bags in the vehicle may differ from the illustration.

Curtain air bags are located along both sides of the roof rails above the front and rear doors.

They are designed to help protect the heads of the front seat occupants and the rear outboard seat occupants in certain side impact collisions.

The curtain air bags are designed to deploy during certain side impact collisions, depending on the crash severity, angle, speed and point of impact. The curtain air bags do not only deploy on the side of the impact but also on the opposite side.

**\* NOTICE - if equipped with rollover sensor**

Also, both sides of the side impact air bags and curtain air bags deploy in certain rollover situations.

- The curtain air bags are not designed to deploy in all side impacts.

**⚠ WARNING**

- In order for side impact and curtain air bags to provide the best protection, both front seat occupants and both outboard rear occupants should sit in an upright position with the seat belts properly fastened.

Importantly, children should sit in a proper child restraint system in the rear seat.

- When children are seated in the rear outboard seats, they must be seated in the proper child restraint system.

Make sure to put the child restraint system as far away from the door side as possible, and secure the child restraint system in a locked position.

(Continued)

(Continued)

- Do not allow the passengers to lean their heads or bodies onto doors, put their arms on the doors, stretch their arms out of the window, or place objects between the doors and passengers when they are seated on seats equipped with side and/or curtain air bags.
- Never try to open or repair any components of the side curtain air bag system. We recommend that the system be serviced by an authorized HYUNDAI dealer.

Failure to follow the above mentioned instructions can result in injury or death to the vehicle occupants in an accident.

**Why didn't my air bag go off in a collision? (Inflation and non-inflation conditions of the air bag)**

There are many types of accidents in which the air bag would not be expected to provide additional protection.

These include rear impacts, second or third collisions in multiple impact accidents, as well as low speed impacts.

*Air bag collision sensors*

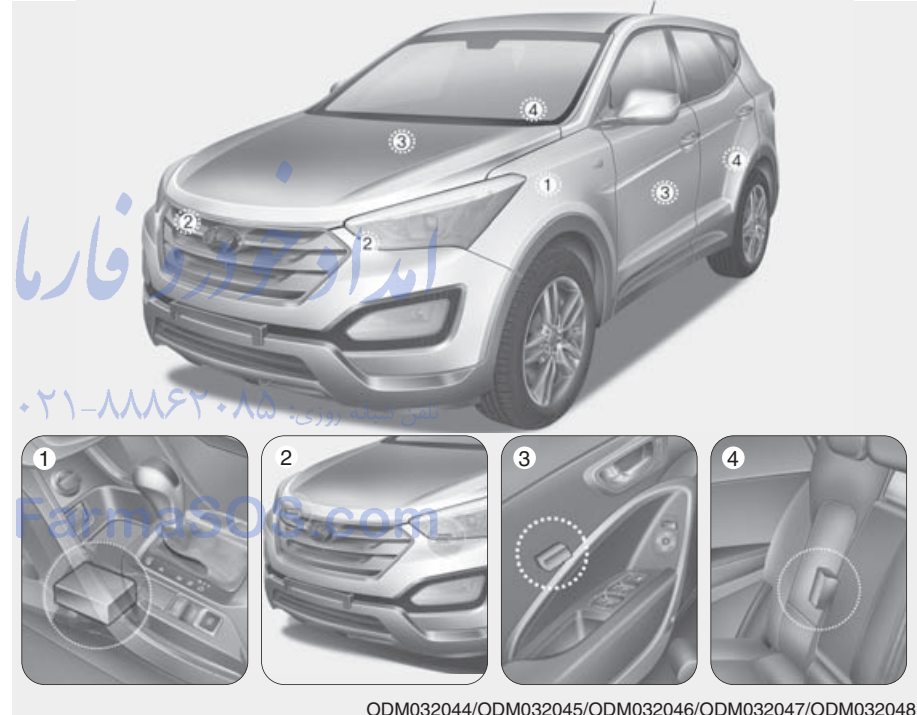

- (1) SRS control module / Rollover sensor (if equipped)
- (2) Front impact sensor

- (3) Side impact sensor (if equipped)
- (4) Side impact sensor (if equipped)

**⚠ WARNING**

- Do not hit or allow any objects to impact the locations where air bag or sensors are installed. This may cause unexpected air bag deployment, which could result in serious personal injury or death.
- If the installation location or angle of the sensors is altered in any way, the air bags may deploy when they should not or they may not deploy when they should, causing severe injury or death. Therefore, do not try to perform maintenance on or around the air bag sensors. We recommend that the system be serviced by an authorized HYUNDAI dealer.
- Problems may arise if the sensor installation angles are changed due to the deformation of the front bumper, body, front door or B pillar and C pillars where side collision sensors are installed.

(Continued)

(Continued)

- We recommend that the system be serviced by an authorized HYUNDAI dealer.
- Your vehicle has been designed to absorb impact and deploy the air bag(s) in certain collisions. Installing bumper guards or replacing a bumper with non-genuine parts may adversely affect your vehicles collision and air bag deployment performance.

**⚠ WARNING - if equipped with rollover sensor**

If your vehicle is equipped with side and curtain air bag, set the ignition switch to OFF or ACC position when the vehicle is being towed.

The side and curtain air bag may deploy when the ignition is ON, and the rollover sensor detects the situation as a rollover.

*Air bag inflation conditions*



**Front air bags**

Front air bags are designed to inflate in a frontal collision depending on the intensity, speed or angles of impact of the front collision.



OVQ036018N



OHM032072

\* The actual air bags in the vehicle may differ from the illustration.

### Side impact and curtain air bags (if equipped)

Side impact and/or curtain air bags are designed to inflate when an impact is detected by side collision sensors depending on the strength, speed or angles of impact resulting from a side impact collision.

Although the front air bags (driver's and front passenger's air bags) are designed to inflate only in frontal collisions, they also may inflate in other types of collisions if the front impact sensors detect a sufficient impact. Side air bags (side impact and/or curtain air bags) are designed to inflate only in side impact collisions, but they may inflate in other collisions if the side impact sensors detect a sufficient impact.

If the vehicle chassis is impacted by bumps or objects on unimproved roads or sidewalks, air bags may deploy. Drive carefully on unimproved roads or on surfaces not designed for vehicle traffic to prevent unintended air bag deployment.

**\* NOTICE - if equipped with rollover sensor**

Also, the side impact and curtain air bags are designed to inflate when a rollover is detected by a rollover sensor.

### Air bag non-inflation conditions



1VQA2086

- In certain low-speed collisions the air bags may not deploy. The air bags are designed not to deploy in such cases because they may not provide benefits beyond the protection of the seat belts in such collisions.



- Air bags are not designed to inflate in rear collisions, because occupants are moved backward by the force of the impact. In this case, inflated air bags would not be able to provide any additional benefit.



- Front air bags may not inflate in side impact collisions, because occupants move to the direction of the collision, and thus in side impacts, frontal air bag deployment would not provide additional occupant protection.
- However, if equipped with side impact and curtain air bags, the air bags may inflate depending on the intensity, vehicle speed and angles of impact.

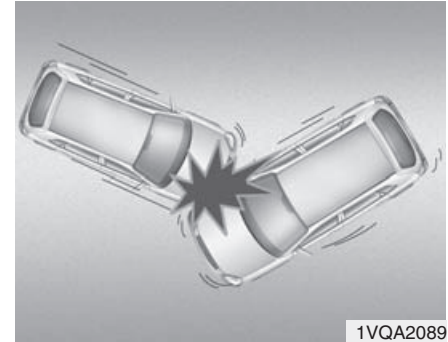

- In an angled collision, the force of impact may direct the occupants in a direction where the air bags would not be able to provide any additional benefit, and thus the sensors may not deploy any air bags.

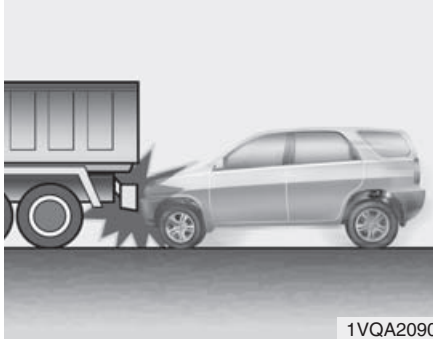

- Just before impact, drivers often brake heavily. Such heavy braking lowers the front portion of the vehicle causing it to “ride” under a vehicle with a higher ground clearance. Air bags may not inflate in this “under-ride” situation because deceleration forces that are detected by sensors may be significantly reduced by such “under-ride” collisions.



- Front air bags may not inflate in rollover accidents because front air bag deployment would not provide additional occupant protection. تلفن

**\* NOTICE - if equipped with rollover sensor**

However, if equipped with side impact and curtain air bags, the air bags may inflate in a rollover, when it is detected by the rollover sensor.

**\* NOTICE - without rollover sensor**

However, side and/or curtain air bags may inflate when the vehicle is rolled over by a side impact collision, if the vehicle is equipped with side impact air bags and curtain air bags.



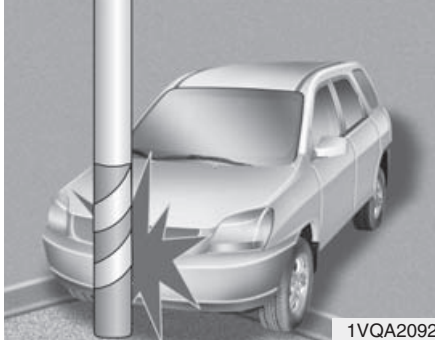

1VQA2092

- Air bags may not inflate if the vehicle collides with objects such as utility poles or trees, where the point of impact is concentrated to one area and the full force of the impact is not delivered to the sensors.

### SRS Care

The SRS is virtually maintenance-free and so there are no parts you can safely service by yourself. If the SRS air bag warning light does not illuminate, or continuously remains on, we recommend that the system be inspected by an authorized HYUNDAI dealer.

#### **⚠ WARNING**

- **Modification to SRS components or wiring, including the addition of any kind of badges to the pad covers or modifications to the body structure, can adversely affect SRS performance and lead to possible injury.**
- **For cleaning the air bag pad covers, use only a soft, dry cloth or one which has been moistened with plain water. Solvents or cleaners could adversely affect the air bag covers and proper deployment of the system.**

(Continued)

(Continued)

- **No objects should be placed over or near the air bag modules on the steering wheel, instrument panel, and the front passenger's panel above the glove box, because any such object could cause harm if the vehicle is in a crash severe enough to cause the air bags to inflate.**
- **If the air bags inflate, we recommend that the system be replaced by an authorized HYUNDAI dealer.**
- **Do not tamper with or disconnect SRS wiring, or other components of the SRS system. Doing so could result in injury, due to accidental inflation of the air bags or by rendering the SRS inoperative.**

(Continued)

**(Continued)**

- If components of the air bag system must be discarded, or if the vehicle must be scrapped, certain safety precautions must be observed. An authorized HYUNDAI dealer knows these precautions and can give you the necessary information. Failure to follow these precautions and procedures could increase the risk of personal injury.
- If your car was flooded and has soaked carpeting or water on flooring, you shouldn't try to start the engine; we recommend that you contact an authorized HYUNDAI dealer.

**Additional safety precautions**

- **Never let passengers ride in the cargo area or on top of a folded-down back seat.** All occupants should sit upright, fully back in their seats with their seat belts on and their feet on the floor.
- **Passengers should not move out of or change seats while the vehicle is moving.** A passenger who is not wearing a seat belt during a crash or emergency stop can be thrown against the inside of the vehicle, against other occupants, or out of the vehicle.
- **Each seat belt is designed to restrain one occupant.** If more than one person uses the same seat belt, they could be seriously injured or killed in a collision.
- **Do not use any accessories on seat belts.** Devices claiming to improve occupant comfort or reposition the seat belt can reduce the protection provided by the seat belt and increase the chance of serious injury in a crash.
- **Passengers should not place hard or sharp objects between themselves and the air bags.** Carrying hard or sharp objects on your lap or in your mouth can result in injuries if an air bag inflates.
- **Keep occupants away from the air bag covers.** All occupants should sit upright, fully back in their seats with their seat belts on and their feet on the floor. If occupants are too close to the air bag covers, they could be injured if the air bags inflate.
- **Do not attach or place objects on or near the air bag covers.** Any object attached to or placed on the front or side impact air bag covers could interfere with the proper operation of the air bags.
- **Do not modify the front seats.** Modification of the front seats could interfere with the operation of the supplemental restraint system sensing components or side air bags.

- **Do not place items under the front seats.** Placing items under the front seats could interfere with the operation of the supplemental restraint system sensing components and wiring harnesses.
- **Never hold an infant or child on your lap.** The infant or child could be seriously injured or killed in the event of a crash. All infants and children should be properly restrained in appropriate child safety seats or seat belts in the rear seat.

### **⚠ WARNING**

- **Sitting improperly or out of position can cause occupants to be shifted too close to a deploying air bag, strike the interior structure or be thrown from the vehicle resulting in serious injury or death.**
- **Always sit upright with the seatback in an upright position, centered on the seat cushion with your seat belt on, legs comfortably extended and your feet on the floor.**

### **Adding equipment to or modifying your air bag-equipped vehicle**

If you modify your vehicle by changing your vehicle's frame, bumper system, front end or side sheet metal or ride height, this may affect the operation of your vehicle's air bag system.

امداد خودرو فارما

تلفن شبانه روزی: ۰۲۱-۸۸۸۶۲۰۸۵

FarmaSOS.com

### **Air bag warning label (if equipped)**

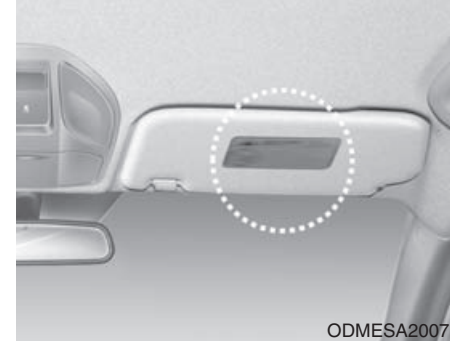

ODMESA2007

Air bag warning labels are attached to alert driver and passengers of potential risk of air bag system.

Note that these government warnings focus on the risk of children. We also want you to be aware of the risks adults are exposed to which have been described in previous pages.

## ACTIVE HOOD LIFT SYSTEM (IF EQUIPPED)

The active hood lift system can reduce a risk of injury to pedestrians by raising the hood in certain accident situations. The active hood lift system has the additional deformation space under the hood, which is made available for the subsequent head impact. When the active hood lift system is activated ;

- The ignition switch is in the on position and the vehicle speed is between about 25km/h (15.5 MPH) and 50 km/h (31 MPH).
- The active hood lift system is designed to work in a frontal collision depending on the intensity, speed or angles of impact of the front collision.

### \* NOTICE - Active hood lift system repair

- If the active hood lift system has been activated, do not place the hood back by yourself. We recommend that the system be repaired by an authorized HYUNDAI dealer.
- If you change or repair the front bumper, we recommend that the system be checked by an authorized HYUNDAI dealer.

### Active hood lift system activation situation



- If the vehicle falls in the gutter or from a high place.

- The active hood lift system may be activated when an impact is detected by frontal collision without pedestrians. If an animal, trash can or other things are struck by your vehicle.
- In certain high-speed frontal or angled collisions, with car or barrier, the active hood lift system may work.

### Active hood lift system non-activation situation

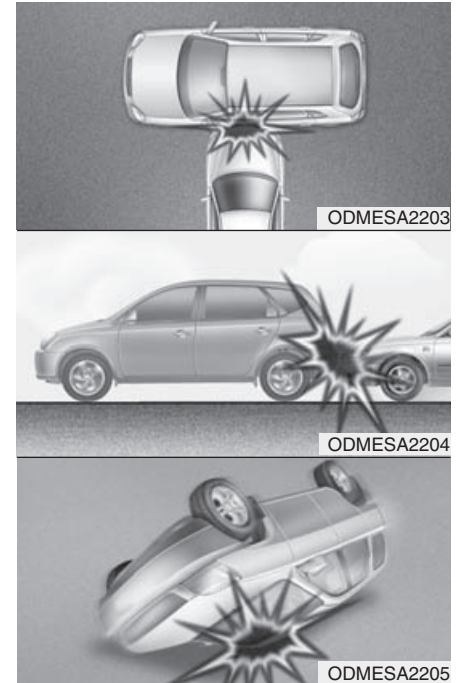

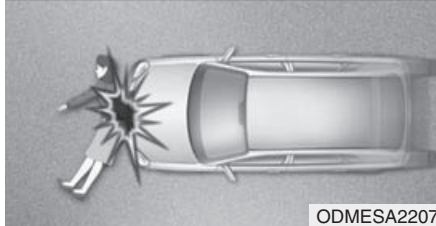

- The active hood lift system is not designed to operate in side, rear collisions and rollover accidents. Because the vehicle can detect only frontal collision.
- If the front bumper is damaged or modified.
- If the vehicle have an angled frontal collision with pedestrians.
- If a pedestrian, lies on the road.
- If the pedestrian have an object to absorb the shock such as a suit case, buggy or cart.

### Active hood lift system malfunction

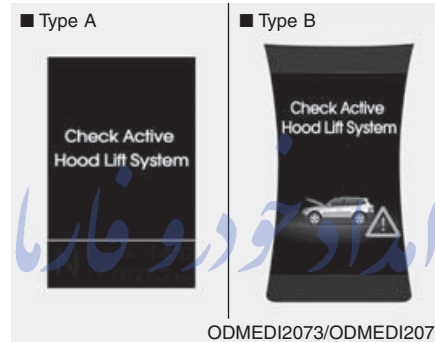

If there is a problem with the system a message will appear in the cluster LCD display.

This warning message means that the protection of pedestrians by the active hood lift system does not work correctly.

If the warning message displayed, we recommend that the system be checked as soon as possible by an authorized HYUNDAI dealer.

### \* NOTICE

- Do not remove or change the components and the wiring of the active hood system.
- Do not change the front bumper or the body structure.
- Do not install or assemble any aftermarket accessory on the front bumper or cover.
- When replacing tires, make sure they are the same size as your original tires. If you drive with different tire or wheel sizes, the active hood lift system may not work normally.

The above situations may cause a malfunction of the active hood lift system.

# Features of your vehicle

<b>Keys</b> .....	4-5	<b>Emergency tailgate safety release</b> .....	4-25
• Record your key number .....	4-5	<b>Windows</b> .....	4-27
• Key operations .....	4-5	• Power windows .....	4-28
• Immobilizer system .....	4-6	<b>Hood</b> .....	4-32
<b>Remote keyless entry</b> .....	4-8	• Opening the hood .....	4-32
• System operation .....	4-8	• Closing the hood .....	4-33
• Transmitter precautions .....	4-10	<b>Fuel filler lid</b> .....	4-34
• Battery replacement .....	4-11	• Opening the fuel filler lid .....	4-34
<b>Smart key</b> .....	4-13	• Closing the fuel filler lid .....	4-34
• Smart key function .....	4-13	• Emergency fuel filler lid release .....	4-36
• Smart key precautions .....	4-14	<b>Panorama sunroof</b> .....	4-37
• Door lock/unlock in an emergency situation .....	4-15	• Sunroof open warning .....	4-37
<b>Theft-alarm system</b> .....	4-16	• Sunshade .....	4-38
• Armed stage .....	4-16	• Sliding the sunroof .....	4-39
• Theft-alarm stage .....	4-18	• Tilting the sunroof .....	4-39
• Disarmed stage .....	4-18	• Closing the sunroof .....	4-40
<b>Door locks</b> .....	4-19	• Resetting the sunroof .....	4-41
• From outside .....	4-19	<b>Steering wheel</b> .....	4-42
• From inside .....	4-20	• Electronic power steering .....	4-42
• Deadlocks .....	4-22	• Power steering .....	4-43
• Door lock/unlock features .....	4-22	• Tilt & telescopic steering .....	4-43
• Child-protector rear door lock .....	4-23	• Heated steering wheel .....	4-44
<b>Tailgate</b> .....	4-24	• Horn .....	4-45
• Opening the tailgate .....	4-24	• Flex steering wheel .....	4-45
• Closing the tailgate .....	4-24		

<b>Mirrors</b> .....	4-48	• Self-diagnosis .....	4-100
• Inside rearview mirror .....	4-48	<b>Parking assist system</b> .....	4-101
• Outside rearview mirror .....	4-52	• Operation .....	4-101
<b>Instrument cluster</b> .....	4-56	• Non-operational conditions .....	4-103
• Instrument Cluster Control .....	4-58	• Self-diagnosis .....	4-105
• LCD Display Control .....	4-59	<b>Smart parking assist system(SPAS)</b> .....	4-106
• Gauges .....	4-59	• Operation .....	4-107
• Transaxle Shift Indicator .....	4-64	• Non-operational conditions .....	4-107
<b>LCD display</b> .....	4-66	• How the system works .....	4-110
• LCD Modes .....	4-66	• Additional instructions .....	4-117
• Service Mode .....	4-67	• System malfunction .....	4-118
• User Settings Mode .....	4-68	<b>Rearview camera</b> .....	4-119
• A/V Mode .....	4-71	<b>Hazard warning flasher</b> .....	4-120
• Turn By Turn Mode .....	4-71	<b>Lighting</b> .....	4-121
• Warning Messages .....	4-72	• Battery saver function .....	4-121
<b>Trip computer</b> .....	4-79	• Headlamp escort function .....	4-121
• Overview .....	4-79	• Smart cornering light .....	4-121
• Trip A/B .....	4-80	• Lighting control .....	4-122
• Fuel Economy .....	4-81	• Traffic change .....	4-124
<b>Warning and indicator lights</b> .....	4-83	• High - beam operation .....	4-125
• Warning lights .....	4-83	• Turn signals and lane change signals .....	4-126
• Indicator Lights .....	4-93	• Front fog light .....	4-127
<b>Rear parking assist system</b> .....	4-98	• Rear fog light .....	4-128
• Operation .....	4-98	• Daytime running light .....	4-128
• Non-operational conditions .....	4-99	• Headlight leveling device .....	4-129

• Adaptive Front Lighting System (AFLS) . . . . .	4-130	• Checking the amount of air conditioner refrigerant and compressor lubricant . . . . .	4-154
<b>Wipers and washers . . . . .</b>	<b>4-131</b>	<b>Automatic climate control system . . . . .</b>	<b>4-155</b>
• Windshield wipers (front) . . . . .	4-132	• Automatic heating and air conditioning . . . . .	4-157
• Windshield washers (front) . . . . .	4-133	• Manual heating and air conditioning . . . . .	4-158
• Rear window wiper and washer switch . . . . .	4-135	• 3rd row air conditioning . . . . .	4-164
<b>Interior light . . . . .</b>	<b>4-136</b>	• System operation . . . . .	4-165
• Interior lamp AUTO cut . . . . .	4-136	• Climate control air filter . . . . .	4-167
• Map lamp . . . . .	4-136	• Air conditioning refrigerant label . . . . .	4-168
• Room lamp . . . . .	4-137	• Checking the amount of air conditioner refrigerant and compressor lubricant . . . . .	4-169
• Vanity mirror lamp . . . . .	4-138	<b>Windshield defrosting and defogging . . . . .</b>	<b>4-170</b>
• Luggage room lamp . . . . .	4-138	• Manual climate control system . . . . .	4-170
• Glove box lamp . . . . .	4-139	• Automatic climate control system . . . . .	4-171
• Door courtesy lamp . . . . .	4-139	<b>Clean air . . . . .</b>	<b>4-173</b>
<b>Welcome system . . . . .</b>	<b>4-140</b>	<b>Storage compartment . . . . .</b>	<b>4-174</b>
• Headlamp welcome . . . . .	4-140	• Center console storage . . . . .	4-174
• Interior light . . . . .	4-140	• Glove box . . . . .	4-174
• Puddle lamp and pocket lamp . . . . .	4-140	• Cool box . . . . .	4-175
<b>Defroster . . . . .</b>	<b>4-141</b>	• Multi box . . . . .	4-176
• Rear window defroster . . . . .	4-141	• Sunglass holder . . . . .	4-176
<b>Manual climate control system . . . . .</b>	<b>4-143</b>	• Luggage tray . . . . .	4-177
• Heating and air conditioning . . . . .	4-144	<b>Interior features . . . . .</b>	<b>4-178</b>
• 3rd row air conditioning . . . . .	4-149	• Cigarette lighter . . . . .	4-178
• System operation . . . . .	4-150	• Ashtray . . . . .	4-178
• Climate control air filter . . . . .	4-152		
• Air conditioning refrigerant label . . . . .	4-153		



- Cup holder ..... 4-179
- Bottle holder ..... 4-180
- Sunvisor ..... 4-180
- Power outlet ..... 4-181
- AC inverter ..... 4-182
- Aux, USB and iPod ..... 4-184
- Clothes hanger ..... 4-185
- Floor mat anchor(s) ..... 4-185
- Luggage net (holder) ..... 4-186
- Cargo security screen ..... 4-186
- Side curtain ..... 4-188
- Exterior features ..... 4-189
  - Roof rack ..... 4-189
- Audio system ..... 4-190
  - Antenna ..... 4-190
  - Audio remote control ..... 4-191

امداد خودرو فارما

تلفن شبانه روزی: ۰۲۱-۸۸۶۲۰۸۵

FarmaSOS.com

## KEYS

### Record your key number



The key code number is stamped on the key code tag attached to the key set. Should you lose

your keys, we recommend that you contact an authorized HYUNDAI dealer. Remove the key code tag and store it in a safe place. Also, record the code number and keep it in a safe and handy place, but not in the vehicle.

### Key operations

- Used to start the engine.
- Used to lock and unlock the doors.
- Used to lock and unlock the glove box.

#### **⚠ WARNING**

We recommend that you use parts for replacement from an authorized HYUNDAI dealer. If an aftermarket key is used, the ignition switch may not return to ON after START. If this happens, the starter will continue to operate causing damage to the starter motor and possible fire due to excessive current in the wiring.

#### **⚠ WARNING**

##### **- Ignition key (Smart key)**

Leaving children unattended in a vehicle with the ignition key (smart key) is dangerous even if the key is not in the ignition switch or the ENGINE START/STOP button is ACC or ON position. Children copy adults and they could place the key in the ignition switch or press the ENGINE START/STOP button.

The ignition key (smart key) would enable children to operate power windows or other controls, or even make the vehicle move, which could result in serious bodily injury or even death. Never leave the keys in your vehicle with unsupervised children, when the engine is running.

### **Immobilizer system**

Your vehicle may be equipped with an electronic engine immobilizer system to reduce the risk of unauthorized vehicle use.

Your immobilizer system is comprised of a small transponder in the key and electronic devices inside the vehicle.

#### ***Vehicles without smart key system***

With the immobilizer system, whenever you insert your ignition key into the ignition switch and turn it to ON, it checks and determines and verifies if the ignition key is valid or not.

If the key is valid, the engine will start.  
If the key is invalid, the engine will not start.

#### **To deactivate the immobilizer system:**

Insert the ignition key into the key cylinder and turn it to the ON position.

#### **To activate the immobilizer system:**

Turn the ignition key to the OFF position. The immobilizer system activates automatically. Without a valid ignition key for your vehicle, the engine will not start.

#### ***Vehicles with smart key system***

Whenever the engine start/stop button is changed to the ON position, the immobilizer system checks and verifies if the key is valid or not.

If the key is valid, the engine will start.

If the key is invalid, the engine will not start.

#### **To deactivate the immobilizer system**

Change the engine start/stop button to the ON position.

#### **To activate the immobilizer system**

Change the engine start/stop button to the OFF position. The immobilizer system activates automatically. Without a valid smart key for your vehicle, the engine will not start.

تلفن شبانه روزی: ۰۲۱-۸۸۸۶۲۰۸۵

**FarmaSOS.com**

**⚠ WARNING**

In order to prevent theft of your vehicle, do not leave spare keys anywhere in your vehicle. Your immobilizer password is a customer unique password and should be kept confidential. Do not leave this number anywhere in your vehicle.

**\* NOTICE**

When starting the engine, do not use the key with other immobilizer keys around. Otherwise the engine may not start or may stop soon after it starts. Keep each key separate in order to avoid a starting malfunction.

**⚠ CAUTION**

*Do not put metal accessories near the ignition switch.  
The engine may not start for the metal accessories may interrupt the transponder signal from normally transmitting.*

**\* NOTICE**

If you need additional keys or lose your keys, we recommend that you consult with an authorized HYUNDAI dealer.

تلفن شبانه روزی: ۰۲۱-۸۸۶۲۰۸۵

FarmaSOS.com

**⚠ CAUTION**

*The transponder in your ignition key is an important part of the immobilizer system. It is designed to give years of trouble-free service, however you should avoid exposure to moisture, static electricity and rough handling. Immobilizer system malfunction could occur.*

**⚠ CAUTION**

*Do not change, alter or adjust the immobilizer system because it could cause the immobilizer system to malfunction and we recommend that the system be serviced by an authorized HYUNDAI dealer.*

*Malfunctions caused by improper alterations, adjustments or modifications to the immobilizer system are not covered by your vehicle manufacturer warranty.*

## REMOTE KEYLESS ENTRY (IF EQUIPPED)

### Remote keyless entry system operations

#### Type A



- To unfold the key, press the release button then the key will unfold automatically.
- To fold the key, fold the key manually while pressing the release button.

#### **CAUTION**

***Do not fold the key without pressing the release button. This may damage the key.***

#### Type B



- To remove the mechanical key, press and hold the release button and remove the mechanical key.
- To reinstall the mechanical key, put the key into the hole and push it until a click sound is heard.

#### Lock (1)

##### ■ Type A

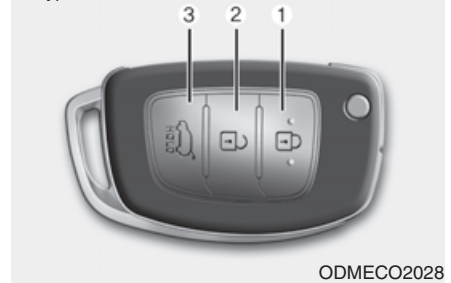

##### ■ Type B

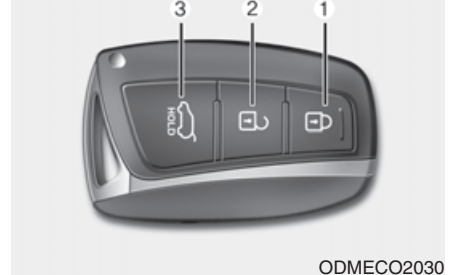

1. Close all doors.
2. Press the lock button.

3. The hazard warning light will blink once to indicate that all doors are locked (the engine hood and tailgate must be closed).

Also, the outside rearview mirror will automatically fold when the outside rearview mirror folding switch is in the AUTO position (if equipped).

#### \* NOTICE

The doors will not lock if any door is opened.

#### **Unlock (2)**

1. Press the unlock button.
2. The hazard warning lights will blink twice to indicate that all doors are unlocked. Also, the outside rearview mirror will automatically unfold when the outside rearview mirror folding switch is in the AUTO position (if equipped).

#### \* NOTICE

After unlocking all doors, the doors will lock automatically unless a door is opened within 30 seconds.

تلفن شبانه روزی: ۰۲۱-۸۸۸۶۲۰۸۵

FarmaSOS.com

#### **Tailgate unlock (3)**

1. Press the tailgate unlock button for more than 1 second.
2. The hazard warning light will blink twice to indicate the tailgate is unlocked.

#### \* NOTICE

- After unlocking the tailgate, the tailgate will lock automatically unless it is opened within 30 seconds.
- Once the tailgate is opened and then closed, the tailgate will lock automatically.
- The word "HOLD" is written on the button to inform you that you must press and hold the button.

### Transmitter precautions

#### \* NOTICE

The transmitter will not work if any of following occur:

- The ignition key is in ignition switch.
  - You exceed the operating distance limit (about 30 m [90 feet]).
  - The battery in the transmitter is weak.
  - Other vehicles or objects may be blocking the signal.
  - The weather is extremely cold.
  - The transmitter is close to a radio transmitter such as a radio station or an airport which can interfere with normal operation of the transmitter.

When the transmitter does not work correctly, open and close the door with the ignition key. If you have a problem with the transmitter, we recommend that you contact an authorized HYUNDAI dealer.

(Continued)

(Continued)

- If the transmitter is in close proximity to your cell phone or smart phone, the signal from the transmitter could be blocked by normal operation of your cell phone or smart phone. This is especially important when the phone is active such as making call, receiving calls, text messaging, and/or sending/ receiving emails. Avoid placing the transmitter and your cell phone or smart phone in the same pants or jacket pocket and maintain adequate distance between the two devices.

#### CAUTION

*Keep the transmitter away from water or any liquid. If the keyless entry system is inoperative due to exposure to water or liquids, it will not be covered by your manufacturer vehicle warranty.*

#### CAUTION

*Changes or modifications not expressly approved by the party responsible for compliance could void the user's authority to operate the equipment. If the keyless entry system is inoperative due to changes or modifications not expressly approved by the party responsible for compliance, it will not be covered by your manufacturer's vehicle warranty.*

#### CAUTION

*Keep the transmitter away from electromagnetic materials that blocks electromagnetic waves to the key surface.*

## Battery replacement

### ■ Type A



### ■ Type B

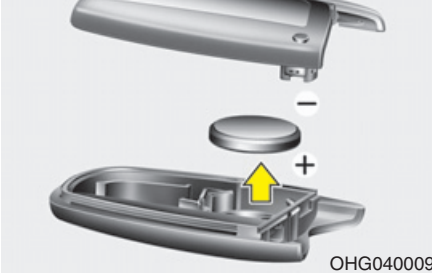

A battery should last for several years, but if the transmitter or smart key is not working properly, try replacing the battery with a new one.

If you are unsure how to use or replace the battery, we recommend that you contact an authorized HYUNDAI dealer.

1. Insert a slim tool into the slot and gently pry open the cover.
2. Replace the battery with a new battery (CR2032). When replacing the battery, make sure the battery position.
3. Install the rear cover.

For transmitter or smart key replacement, we recommend that you see an authorized HYUNDAI dealer for reprogramming.

FarmaSOS.com

### ⚠ CAUTION

- *The transmitter or smart key is designed to give you years of trouble-free use, however it can malfunction if exposed to moisture or static electricity. If you are unsure how to use or replace the battery, we recommend that you contact an authorized HYUNDAI dealer.*
- *Using the wrong battery can cause the transmitter or smart key to malfunction. Be sure to use the correct battery.*
- *To avoid damaging the transmitter or smart key, don't drop it, get it wet, or expose it to heat or sunlight.*



**⚠ CAUTION**

*An inappropriately disposed battery can be harmful to the environment and human health.*

*Dispose the battery according to your local law(s) or regulation.*

امداد خودرو فارما

تلفن شبانه روزی: ۰۲۱-۸۸۸۶۲۰۸۵

FarmaSOS.com

## SMART KEY (IF EQUIPPED)

### Smart key function

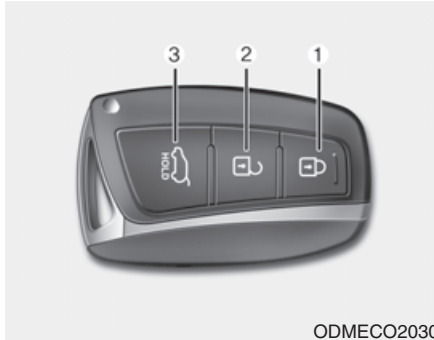

1. Door lock
2. Door unlock
3. Tailgate open

With a smart key, you can lock or unlock a door and tailgate and even start the engine without inserting the key.

The functions of the buttons on a smart key are similar to the remote keyless entry. Refer to the “Remote keyless entry” in this section.



Carrying the smart key, you may lock and unlock the vehicle doors and tailgate.

Also, you may start the engine. Refer to the following, for more details.

[FarmaSOS.com](http://FarmaSOS.com)

### Locking

1. Carry the smart key.
2. Close all doors.
3. Press the button of the outside door handle.
4. The hazard warning lights will blink once (the engine hood and tailgate must be closed). Also, the outside rearview mirror will automatically fold when the outside rearview mirror folding switch is in the AUTO position (if equipped).
5. Make sure that doors are locked by pulling the outside door handle.

### \* NOTICE

- The button will only operate when the smart key is within 0.7 m (28 in.) from the outside door handle.
- Even though you press the outside door handle button, the doors will not lock and the chime will sound for 3 seconds if any of following occur:
  - The smart key is in the vehicle.
  - The engine start/stop button is in ACC or ON position.
  - Any door or the tailgate is opened.

### **Unlocking**

1. Carry the smart key.
2. Press the button of the front outside door handle.
3. All doors will unlock and the hazard warning lights will blink twice. Also, the outside rearview mirror will automatically unfold when the outside rearview mirror folding switch is in the AUTO position (if equipped).

### **\* NOTICE**

- The button will only operate when the smart key is within 0.7 m (28 in.) from the outside door handle.
- When the smart key is recognized in the area of 0.7 m (28 in.) from the front outside door handle, other people can also open the doors.
- After unlocking all doors, the doors will lock automatically unless a door is opened.

### **Tailgate unlocking**

1. Carry the smart key.
2. Press the tailgate handle switch.
3. The tailgate will unlock.

### **\* NOTICE**

- Once the tailgate is opened and then closed, the tailgate will lock automatically.
- The button will only operate when the smart key is within 0.7 m (28 in.) from the tailgate handle.

تلفن شبانه روزی: ۰۲۱-۸۸۸۶۲۰۸۵

FarmaSOS.com

### **Smart key precautions**

#### **\* NOTICE**

- If, for some reason, you happen to lose your smart key, you will not be able to start the engine. Tow the vehicle, if necessary, and we recommend that you contact an authorized HYUNDAI dealer.
- A maximum of 2 smart keys can be registered to a single vehicle. If you lose a smart key, we recommend that you take the vehicle and key to your authorized HYUNDAI dealer to protect it from potential theft.
- The smart key will not work if any of the following occurs:
  - The smart key is close to a radio transmitter such as a radio station or an airport which can interfere with normal operation of the smart key.
  - The smart key is near a mobile two-way radio system or a cellular phone.
  - Another vehicle's smart key is being operated close to your vehicle.

(Continued)

(Continued)

When the smart key does not work properly, open and close the door with the mechanical key. If you have a problem with the smart key, we recommend that you contact an authorized HYUNDAI dealer.

- If the smart key is in close proximity to your cell phone or smart phone, the signal from the smart key could be blocked by normal operation of your cell phone or smart phone. This is especially important when the phone is active such as making call, receiving calls, text messaging, and/or sending/ receiving emails. Avoid placing the smart key and your cell phone or smart phone in the same pants or jacket pocket and maintain adequate distance between the two devices.

**⚠ CAUTION**

**Keep the smart key away from water or any liquid. If the keyless entry system is inoperative due to exposure to water or liquids, it will not be covered by your manufacturer's vehicle warranty.**

**⚠ CAUTION**

**Keep the smart key away from electromagnetic materials that blocks electromagnetic waves to the key surface.**

امداد خودرو فارما

تلفن شبانه روزی: ۰۲۱-۸۸۸۶۲۰۸۵

FarmaSOS.com

**Door lock/unlock in an emergency situation**

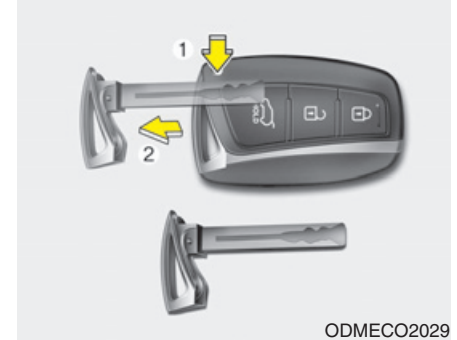

If the smart key does not operate normally, you can lock or unlock the doors by using the mechanical key.

1. Press and hold the release button (1) and remove the mechanical key (2).
2. Insert the key into the hole of the outside door handle. Turn the key toward the rear of the vehicle to unlock and toward the front of the vehicle to lock.
3. To reinstall the mechanical key, put the key into the hole and push it until a click sound is heard.

## THEFT-ALARM SYSTEM (IF EQUIPPED)



Vehicles equipped with a theft alarm system will have a label attached to the vehicle with the following words:

1. WARNING
2. SECURITY SYSTEM

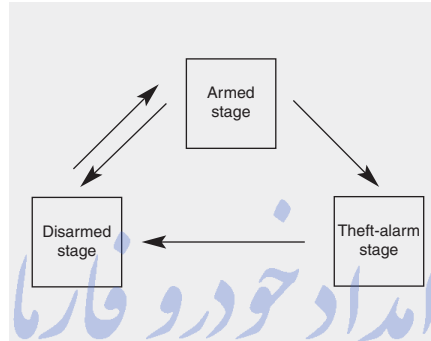

This system is designed to provide protection from unauthorized entry into the vehicle. This system is operated in three stages: the first is the "Armed" stage, the second is the "Theft-alarm" stage, and the third is the "Disarmed" stage. If triggered, the system provides an audible alarm with blinking of the hazard warning lights.

### Armed stage

#### *Using the smart key*

Park the vehicle and stop the engine. Arm the system as described below.

1. Turn off the engine.
2. Make sure that all doors, the engine hood and tailgate/trunk are closed and latched.
3. Lock the doors by pressing the button of the front outside door handle with the smart key in your possession.

After completion of the steps above, the hazard warning lights will operate once to indicate that the system is armed.

If the tailgate/trunk or engine hood remains opened, the hazard warning lights will not operate and theft-alarm will not arm. After this, if the tailgate/ trunk and engine hood are closed, the hazard warning lights will blink once.

- Lock the doors by pressing the lock button on the smart key.

After completion of the steps above, the hazard warning lights will operate once to indicate that the system is armed.

If any door, tailgate/trunk or engine hood remains open, the hazard warning lights won't operate and theft-alarm will not arm. After this, if all doors, tailgate/trunk and engine hood are closed, the hazard warning lights will blink once.

### *Using the transmitter*

Park the vehicle and stop the engine. Arm the system as described below.

1. Turn off the engine and remove the ignition key from the ignition switch.
2. Make sure that all doors, the engine hood and tailgate/trunk are closed and latched.
3. Lock the doors by pressing the lock button on the transmitter.

After completion of the steps above, the hazard warning lights will blink once to indicate that the system is armed.

If any door, tailgate/trunk or engine hood remains opened, the hazard warning lights will not operate and theft-alarm will not arm. After this, if all doors, tailgate/trunk and engine hood are closed, the hazard warning lights will blink once.

- **Do not arm the system until all passengers have left the vehicle. If the system is armed while a passenger(s) remains in the vehicle, the alarm may be activated when the remaining passenger(s) leave the vehicle. If any door, tailgate/trunk lid or engine hood is opened within 30 seconds after entering the armed stage, the system is disarmed to prevent unnecessary alarm.**

### Theft-alarm stage

The alarm will be activated if any of the following occurs while the system is armed.

- A front or rear door is opened without using transmitter or smart key.
- The tailgate/trunk is opened without using transmitter or smart key.
- The engine hood is opened.

The siren will sound and the hazard warning lights will blink continuously for 27 seconds, unless the system is disarmed. To turn off the system, unlock the doors with the transmitter or smart key.

### Disarmed stage

The system will be disarmed when:

#### *Transmitter*

- The door unlock button is pressed.
- The engine is started.
- The ignition switch is in the "ON" position for 30 seconds or more.

#### *Smart key*

- The door unlock button is pressed.
- The button of the front outside door is pressed while carrying the smart key.
- The engine is started.
- The engine start/stop button is turned to the ON position.

After the doors are unlocked, the hazard warning lights will blink twice to indicate that the system is disarmed.

After pressing the unlock button, if any door (or tailgate/trunk) is not opened within 30 seconds, the system will be rearmed.

### \* NOTICE

- **Without smart key system**  
If the system is not disarmed with the transmitter, insert the key into the ignition switch and start the engine. Then the system will be disarmed.
- **With smart key system**  
If the system is not disarmed with the smart key, open the door with the mechanical key and start the engine. Then the system will be disarmed.
- **If you lose your keys, we recommend that you consult with your authorized HYUNDAI dealer.**

### CAUTION

***Do not change, alter or adjust the theft-alarm system because it could cause the theft-alarm system to malfunction and we recommend that the system be serviced by an authorized HYUNDAI dealer.***

***Malfunctions caused by improper alterations, adjustments or modifications to the theft-alarm system are not covered by your vehicle manufacturer warranty.***

## DOOR LOCKS

### Operating door locks from outside the vehicle

#### Mechanical key

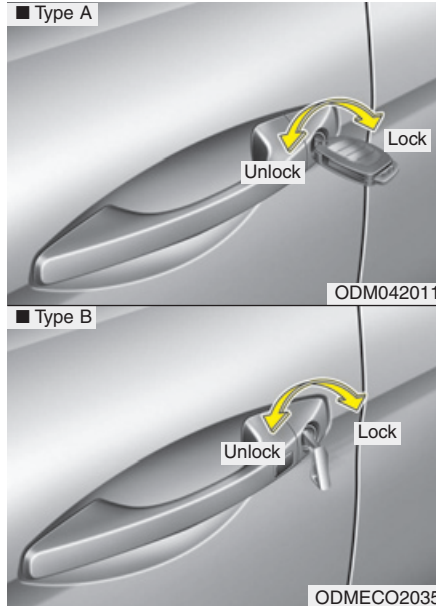

- Turn the key toward the rear of the vehicle to lock and toward the front of the vehicle to unlock.
- If you lock/unlock the driver's door with a key, only the driver's door will lock/unlock.
- Once the door is unlocked, it may be opened by pulling the door handle.
- When closing the door, push the door by hand. Make sure that doors are closed securely.

تلفن شبانه روزی: ۰۲۱-۸۸۸۶۲۰۸۵

FarmaSOS.com

#### Transmitter/Smart key

- Doors can be locked and unlocked with the transmitter or smart key.
- Doors can be locked and unlocked pressing the button of the outside door handle with the smart key in your possession. (vehicles equipped with smart key system)
- Once the doors are unlocked, they may be opened by pulling the door handle.
- When closing the door, push the door by hand. Make sure that doors are closed securely.

#### \* NOTICE

- In cold and wet climates, door lock and door mechanisms may not work properly due to freezing conditions.
- If the door is locked/unlocked multiple times in rapid succession with either the vehicle key or door lock switch, the system may stop operating temporarily in order to protect the circuit and prevent damage to system components.



### **⚠ WARNING**

- If you don't close the door securely, the door may open again.
- Be careful that someone's body and hands are not trapped when closing the door.

### **Operating door locks from inside the vehicle**

*With the door lock button*

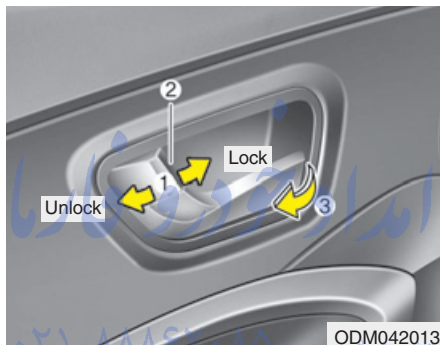

- To unlock a door, push the door lock button (1) to the “Unlock” position. The red mark (2) on the button will be visible.
- To lock a door, push the door lock button (1) to the “Lock” position. If the door is locked properly, the red mark (2) on the door lock button will not be visible.
- To open a door, pull the door handle (3) outward.

- If the inner door handle of the front door is pulled when the door lock button is in lock position, the button is unlocked and door opens. (Except Europe)
- If the inner door handle of any door is pulled when the door lock button is in lock position, the button is unlocked and door opens. (For Europe )
- Front doors cannot be locked if the ignition key is in the ignition switch and any front door is opened. (Except Europe)
- Doors cannot be locked if the ignition key is in the ignition switch and any door is opened. (For Europe)
- Doors cannot be locked if the smart key is in the vehicle and any door is opened.

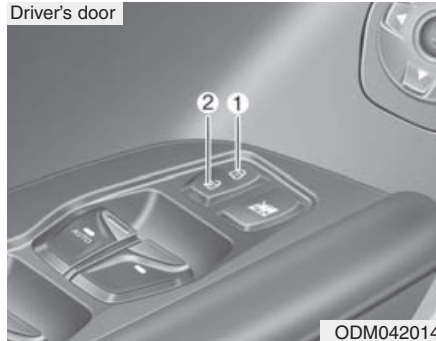
**With central door lock switch**

Operate by depressing the central door lock switch.

- When pushing down on the front portion (1) of the switch, all vehicle doors will lock.
- When pushing down on the rear portion (2) of the switch, all vehicle doors will unlock.
- If the key is in the ignition switch and any front door is open, the doors will not lock when the front portion (1) of central door lock switch is pressed. (Except Europe)

- If the key is in the ignition switch and any door is open, the doors will not lock when the front portion (1) of the central door lock switch is pressed. (For Europe)
- If the smart key is in the vehicle and any door is open the doors will not lock when the front portion (1) of central door lock switch is pressed.

**\* NOTICE**

Once the doors are locked with the transmitter or smart key, the doors cannot be unlocked with the central door lock/unlock switch.

FarmaSOS.com

**⚠ WARNING - Doors**

- The doors should always be fully closed and locked while the vehicle is in motion to prevent accidental opening of the door. Locked doors will also discourage potential intruders when the vehicle stops or slows down.
- Be careful when opening doors and watch for vehicles, motorcycles, bicycles or pedestrians approaching the vehicle in the path of the door. Opening a door when something is approaching can cause damage or injury.

### **⚠ WARNING - Unlocked vehicles**

Leaving your vehicle unlocked can invite theft or possible harm to you or others from someone hiding in your vehicle while you are gone. Always remove the ignition key, engage the parking brake, close all windows and lock all doors when leaving your vehicle unattended.

### **⚠ WARNING - Unattended children**

An enclosed vehicle can become extremely hot, causing death or severe injury to unattended children or animals who cannot escape the vehicle. Furthermore, children might operate features of the vehicle that could injure them, or they could encounter other harm, possibly from someone gaining entry to the vehicle. Never leave children or animals unattended in your vehicle.

### **Deadlocks (if equipped)**

Some vehicles are equipped with a deadlock system. Deadlocks prevent opening of a door from either inside or outside the vehicle once the deadlocks have been activated providing an additional measure of vehicle security.

To lock the vehicle using the deadlock function, the doors must be locked by using the transmitter or smart key. To unlock the vehicle, the transmitter or smart key must be used again.

### **⚠ WARNING**

Do not lock the doors with the transmitter or the smart key with anybody left in the vehicle. The passenger in the vehicle cannot unlock the doors with the door lock button. For example, if the door is locked with the transmitter, the passenger in the vehicle cannot unlock the door without the transmitter.

### **Door lock/unlock features**

#### ***Impact sensing door unlock system***

All doors will automatically unlock when an impact causes the air bags to deploy.

#### ***Speed sensing door lock system (if equipped)***

All doors will automatically lock after the vehicle speed exceeds 15 km/h.

You can activate or deactivate the auto door lock/unlock features in the vehicle. Refer to "User setting" in this section.

## Child-protector rear door lock

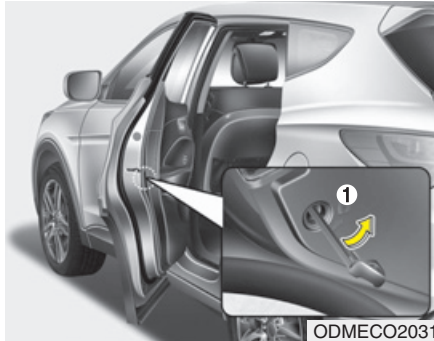

The child safety lock is provided to help prevent children from accidentally opening the rear doors from inside the vehicle. The rear door safety locks should be used whenever children are in the vehicle.

1. Open the rear door.
2. Insert a key (or screwdriver) into the hole (1) and turn it to the “lock (🔒)” position. When the child safety lock is in the lock position, the rear door will not open even though the inner door handle is pulled inside the vehicle.

3. Close the rear door.

To open the rear door, pull the outside door handle.

Even though the doors may be unlocked, the rear door will not open by pulling the inner door handle until rear door child safety lock is unlocked.

### **⚠ WARNING - Rear door locks**

**If children accidentally open the rear doors while the vehicle is in motion, they could fall out and be severely injured or killed. To prevent children from opening the rear doors from the inside, the rear door safety locks should be used whenever children are in the vehicle.**

## TAILGATE

### Opening the tailgate

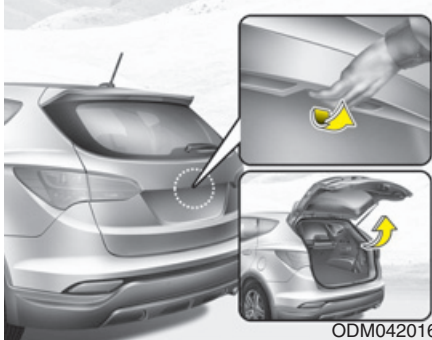

- The tailgate is locked or unlocked when all doors are locked or unlocked with the key, transmitter, smart key or central door lock/unlock switch.
- Only the tailgate is unlocked if the tailgate unlock button on the transmitter or smart key is pressed for approximately 1 second.
- If unlocked, the tailgate can be opened by pressing the handle and pulling it up.
- Once the tailgate is opened and then closed, the tailgate locks automatically. (All doors must be locked.)

### \* NOTICE

In cold and wet climates, door lock and door mechanisms may not work properly due to freezing conditions.

#### ⚠ WARNING

The tailgate swings upward. Make sure no objects or people are near the rear of the vehicle when opening the tailgate.

#### ⚠ CAUTION

*Make certain that you close the tailgate before driving your vehicle. Possible damage may occur to the tailgate lift cylinders and attaching hardware if the tailgate is not closed prior to driving.*

### Closing the tailgate



Lower and push down the tailgate firmly. Make sure that the tailgate is securely latched.

#### ⚠ WARNING

Make sure your hands, feet and other parts of your body are safely out of the way before closing the tailgate.

**⚠ CAUTION**

*Make sure nothing is near the tailgate latch and striker while closing the tailgate. It may damage the tailgate's latch.*

**⚠ WARNING - Exhaust fumes**

If you drive with the tailgate opened, you will draw dangerous exhaust fumes into your vehicle which can cause serious injury or death to vehicle occupants.

If you must drive with the tailgate opened, keep the air vents and all windows open so that additional outside air comes into the vehicle.

**⚠ WARNING - Rear cargo area**

Occupants should never ride in the rear cargo area where no restraints are available. To avoid injury in the event of an accident or sudden stops, occupants should always be properly restrained.

انداز خودرو فارما

تلفن شبانه روزی: ۰۲۱-۸۸۸۶۲۰۸۵

FarmaSOS.com

**Emergency tailgate safety release**

ODM042018

Your vehicle is equipped with the emergency tailgate safety release lever located on the bottom of the tailgate. When someone is inadvertently locked in the luggage compartment. The tailgate can be opened by doing as follows:

1. Remove the cover.
2. Push the release lever to the right.
3. Push up the tailgate.

**⚠ WARNING**

- For emergencies, be fully aware of the location of the emergency tailgate safety release lever in the vehicle and how to open the tailgate if you are accidentally locked in the luggage compartment.
- No one should be allowed to occupy the luggage compartment of the vehicle at any time. The luggage compartment is a very dangerous location in the event of a crash.
- Use the release lever for emergencies only. Use with extreme caution, especially while the vehicle is in motion.

امداد خودرو فارما

تلفن شبانه روزی: ۰۲۱-۸۸۸۶۲۰۸۵

FarmaSOS.com

## WINDOWS

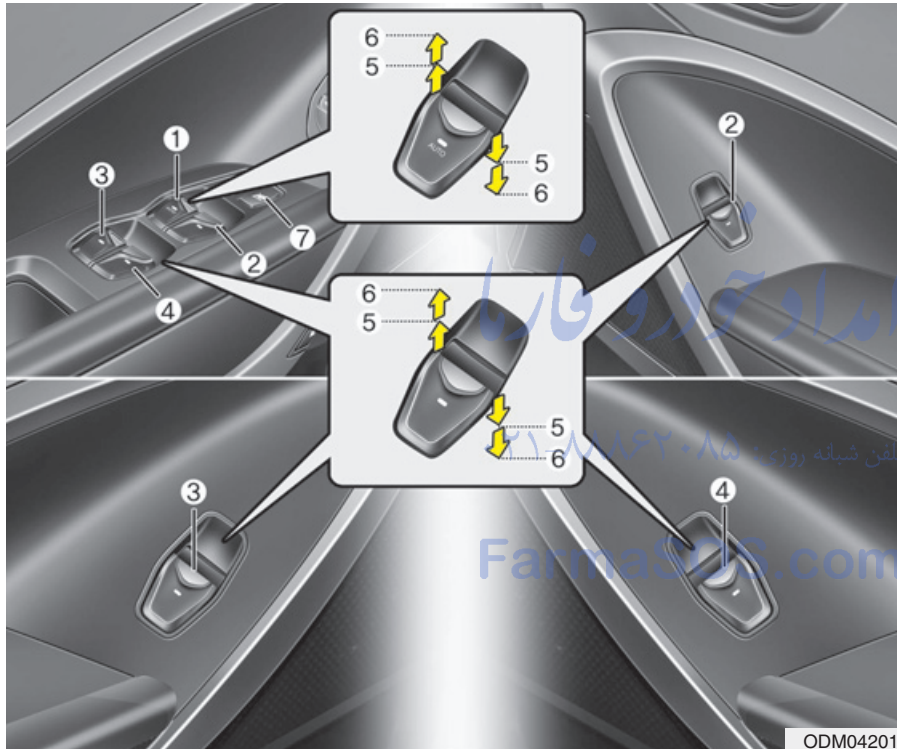

- (1) Driver's door power window switch
- (2) Front passenger's door power window switch
- (3) Rear door (left) power window switch
- (4) Rear door (right) power window switch
- (5) Window opening and closing
- (6) Automatic power window up\*/down\*
- (7) Power window lock switch

\*: if equipped

### \* NOTICE

In cold and wet climates, power windows may not work properly due to freezing conditions.

ODM042019



### Power windows

The ignition switch must be in the ON position for power windows to operate. Each door has a power window switch that controls the door's window. The driver's door has a master power window switch that controls all the windows in the vehicle. Also, the driver has a power window lock switch which can block the operation of rear passenger windows.

The power windows can be operated for approximately 30 seconds after the ignition key is removed or turned to the ACC or LOCK position. However, if the front doors are opened, the power windows cannot be operated even within the 30 seconds period.

### \* NOTICE

While driving with the rear windows down or with the sunroof (if equipped) in an open (or partially open position), your vehicle may demonstrate a wind buffeting or pulsation noise. This noise is a normal occurrence and can be reduced or eliminated by taking the following actions. If the noise occurs with one or both of the rear windows down, partially lower both front windows approximately one inch. If you experience the noise with the sunroof open, slightly reduce the size of the sunroof opening.

FarmaSOS.com

### Window opening and closing

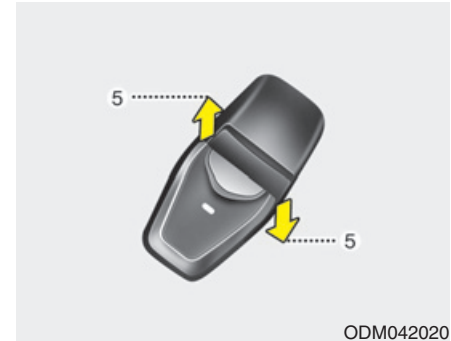

#### Type A

To open or close a window, press down or pull up the front portion of the corresponding switch to the first detent position (5).

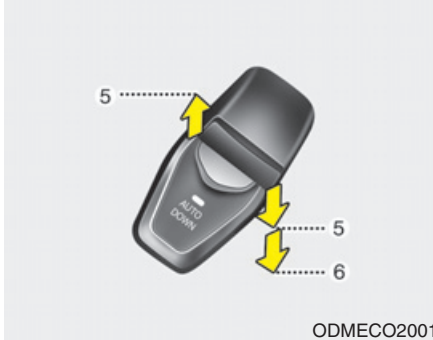

### Type B

#### Auto down window (if equipped)

Pressing the power window switch momentarily to the second detent position (6) completely lowers the window even when the switch is released. To stop the window at the desired position while the window is in operation, pull up the switch momentarily to the opposite direction of the window movement.



### Type C

#### Auto up/down window (if equipped)

Pressing or pulling up the power window switch momentarily to the second detent position (6) completely lowers or lifts the window even when the switch is released. To stop the window at the desired position while the window is in operation, pull up or press down and release the switch.

### \* NOTICE

If the power window does not operate normally, the automatic power window system must be reset as follows:

1. Turn the ignition switch to the ON position.
2. Close the driver's window and continue pulling up the driver's power window switch for at least 1 second after the window is completely closed.

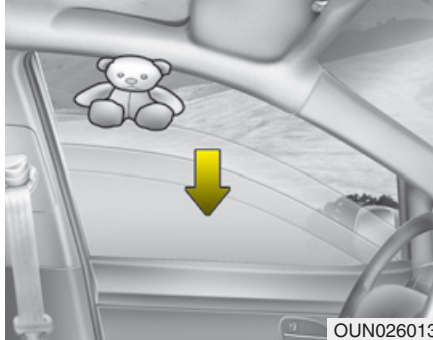

### Automatic reversal

If the upward movement of the window is blocked by an object or part of the body, the window will detect the resistance and will stop upward movement. The window will then lower approximately 30 cm (11.8 in.) to allow the object to be cleared.

If the window detects the resistance while the power window switch is pulled up continuously, the window will stop upward movement then lower approximately 2.5 cm (1 in.).

And if the power window switch is pulled up continuously again within 5 seconds after the window is lowered by the automatic window reversal feature, the automatic window reversal will not operate.

### \* NOTICE

The automatic reverse feature is only active when the “auto up” feature is used by fully pulling up the switch. The automatic reverse feature will not operate if the window is raised using the halfway position on the power window switch.

### **⚠ WARNING**

**Always check for obstructions before raising any window to avoid injuries or vehicle damage. If an object less than 4 mm (0.16 in.) in diameter is caught between the window glass and the upper window channel, the automatic reverse window may not detect the resistance and will not stop and reverse direction.**

### Power window lock button



The driver can disable the power window switches on the rear passengers' doors by pressing the power window lock switch to the lock position (pressed).

When the power window lock switch is pressed :

- The driver's master control can operate all the power windows.
- The front passenger's control can operate the front passenger's power window.
- The rear passenger's control cannot operate the rear passenger's power window.

**⚠ CAUTION**

- *To prevent possible damage to the power window system, do not open or close two windows or more at the same time. This will also ensure the longevity of the fuse.*
- *Never try to operate the main switch on the driver's door and the individual door window switch in opposing directions at the same time. If this is done, the window will stop and cannot be opened or closed.*

**⚠ WARNING - Windows**

- **NEVER** leave the keys in your vehicle with unsupervised children, when the engine is running.
- **NEVER** leave any child unattended in the vehicle. Even very young children may inadvertently cause the vehicle to move, entangle themselves in the windows, or otherwise injure themselves or others.
- Always double check to make sure all arms, hands, head and other obstructions are safely out of the way before closing a window.
- Do not allow children to play with the power windows. Keep the driver's door power window lock switch in the LOCK position (pressed). Serious injury can result from unintentional window operation by the child.
- Do not extend face or arms outside the window while driving.

## HOOD

### Opening the hood

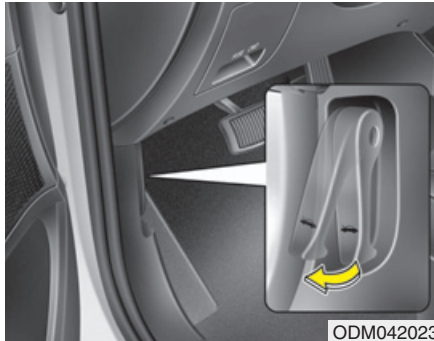

1. Pull the release lever to unlatch the hood. The hood should pop open slightly.

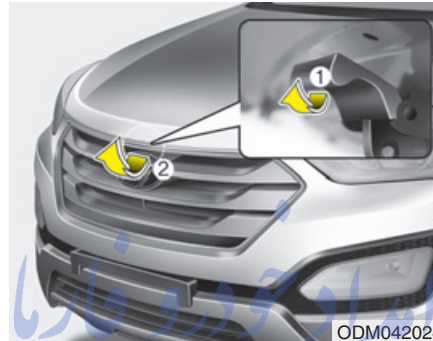

2. Go to the front of the vehicle, raise the hood slightly, push up the secondary latch (1) inside of the hood center and lift the hood (2).  
تلفن شبانه: ۰۲۱-۸۸۸۸۸۸۸۸
3. Raise the hood. It will raise completely by itself after it has been raised halfway.

### **⚠ WARNING**

Open the hood after turning off the engine on a flat surface, shifting the shift lever to the P(Park) position for automatic transaxle and to the 1(First) gear or R(Reverse) for manual transaxle, and setting the parking brake.

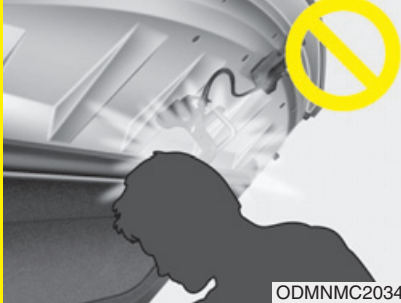
**⚠ WARNING**

When you check the engine compartment, please make sure your head is not injured by the hood safety hook which is located inside of the hood.

**Closing the hood**

1. Before closing the hood, check the following:
  - All filler caps in engine compartment must be correctly installed.
  - Gloves, rags or any other combustible material must be removed from the engine compartment.
2. Lower the hood halfway and push it down. Make sure the hood is locked securely

**⚠ WARNING - Hood**

- Before closing the hood, ensure that all obstructions are removed from the hood opening. Closing the hood with an obstruction present in the hood opening may result in property damage or severe personal injury.
- Do not leave gloves, rags or any other combustible material in the engine compartment. Doing so may cause a heat-induced fire.

**⚠ WARNING**

- Always double check to be sure that the hood is firmly latched before driving away. If it is not latched, the hood could fly open while the vehicle is being driven, causing a total loss of visibility, which might result in an accident.
- Do not move the vehicle with the hood raised. The view will be blocked and the hood could fall or be damaged.

## FUEL FILLER LID

### Opening the fuel filler lid

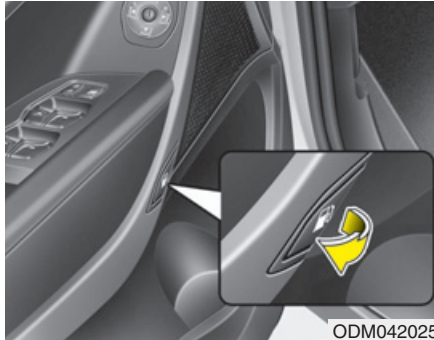

ODM042025

The fuel-filler lid must be opened from inside the vehicle by pulling up on the fuel-filler lid opener located on the driver's door.

#### \* NOTICE

If the fuel-filler lid will not open because ice has formed around it, tap lightly or push on the lid to break the ice and release the lid. Do not pry on the lid. If necessary, spray around the lid with an approved de-icer fluid (do not use radiator anti-freeze) or move the vehicle to a warm place and allow the ice to melt.

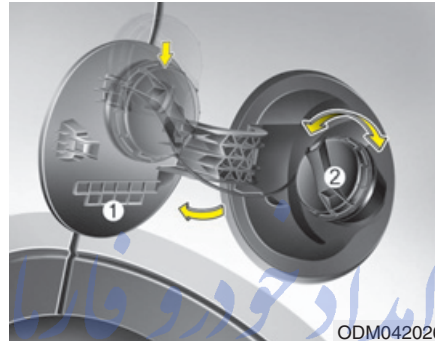

ODM042026

1. Stop the engine.
2. To open the fuel filler lid, pull the fuel filler lid opener up.
3. Pull the fuel filler lid (1) out to fully open.
4. To remove the cap (2), turn the fuel tank cap counterclockwise.
5. Refuel as needed.

### Closing the fuel filler lid

1. To install the cap, turn it clockwise until it "clicks". This indicates that the cap is securely tightened.
2. To close the lid, press the edge of the lid. Make sure it is securely closed.

#### **⚠ WARNING - Refueling**

- If pressurized fuel sprays out, it can cover your clothes or skin and thus subject you to the risk of fire and burns. Always remove the fuel cap carefully and slowly. If the cap is venting fuel or if you hear a hissing sound, wait until the condition stops before completely removing the cap.
- Do not "top off" after the nozzle automatically shuts off when refueling.
- Always check that the fuel cap is installed securely to prevent fuel spillage in the event of an accident.

**⚠ WARNING - Refueling dangers**

Automotive fuels are flammable materials. When refueling, please note the following guidelines carefully. Failure to follow these guidelines may result in severe personal injury, severe burns or death by fire or explosion.

- Read and follow all warning posted at the gas station facility.
- Before refueling note the location of the Emergency Gasoline Shut-Off, if available, at the gas station facility.

(Continued)

(Continued)

- Before touching the fuel nozzle, you should eliminate potentially dangerous static electricity discharge by touching another metal part of the vehicle, a safe distance away from the fuel filler neck, nozzle, or other gas source.
- Do not get back into a vehicle once you have begun refueling since you can generate static electricity by touching, rubbing or sliding against any item or fabric (polyester, satin, nylon, etc.) capable of producing static electricity. Static electricity discharge can ignite fuel vapors resulting in rapid burning. If you must re-enter the vehicle, you should once again eliminate potentially dangerous static electricity discharge by touching a metal part of the vehicle, away from the fuel filler neck, nozzle or other gasoline source.

(Continued)

(Continued)

- When using an approved portable fuel container, be sure to place the container on the ground prior to refueling. Static electricity discharge from the container can ignite fuel vapors causing a fire. Once refueling has begun, contact with the vehicle should be maintained until the filling is complete.

Use only portable plastic fuel containers designed to carry and store gasoline.

- Do not use cellular phones while refueling. Electric current and/or electronic interference from cellular phones can potentially ignite fuel vapors causing a fire.

(Continued)



### (Continued)

- When refueling, always shut the engine off. Sparks produced by electrical components related to the engine can ignite fuel vapors causing a fire. Once refueling is complete, check to make sure the filler cap and filler door are securely closed, before starting the engine.
- DO NOT use matches or a lighter and DO NOT SMOKE or leave a lit cigarette in your vehicle while at a gas station especially during refueling. Automotive fuel is highly flammable and can, when ignited, result in fire.
- If a fire breaks out during refueling, leave the vicinity of the vehicle, and immediately contact the manager of the gas station and then contact the local fire department. Follow any safety instructions they provide.

### CAUTION

- *Make sure to refuel your vehicle according to the "Fuel requirements" suggested in section 1.*
- *If the fuel filler cap requires replacement, please make sure that you use parts designed for replacement in your vehicle. An incorrect fuel filler cap can result in a serious malfunction of the fuel system or emission control system. For more detailed information, we recommend that you contact an authorized HYUNDAI dealer.*
- *Do not spill fuel on the exterior surfaces of the vehicle. Any type of fuel spilled on painted surfaces may damage the paint.*
- *After refueling, make sure the fuel cap is installed securely to prevent fuel spillage in the event of an accident.*

### Emergency fuel filler lid release

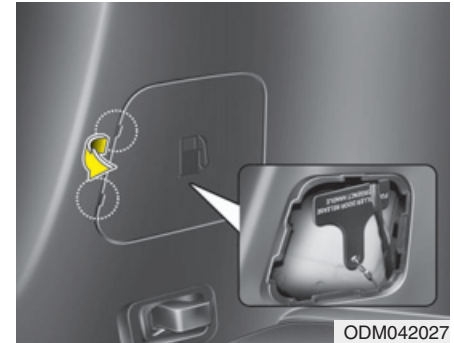

If the fuel filler lid does not open using the remote fuel filler lid release, you can open it manually. Remove the panel in the luggage compartment area. Pull the handle out slightly.

### CAUTION

*Do not pull the handle excessively, otherwise the luggage compartment area trim or release handle may be damaged.*

## PANORAMA SUNROOF (IF EQUIPPED)

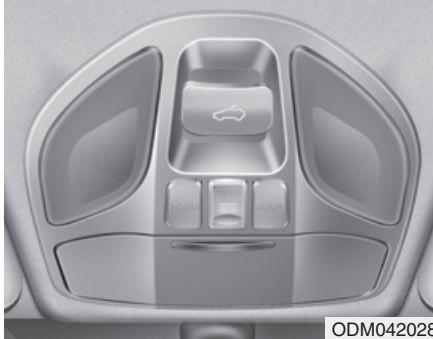

ODM042028

If your vehicle is equipped with a sunroof, you can slide or tilt your sunroof with the sunroof control lever located on the overhead console.

The sunroof can only be opened, closed, or tilted when the ignition switch is in the ON position.

- In cold and wet climates, the sunroof may not work properly due to freezing conditions.
- After the vehicle is washed or in a rainstorm, be sure to wipe off any water that is on the sunroof before operating it.

### **CAUTION - Sunroof control lever**

***Do not continue to move the sunroof control lever after the sunroof is fully opened, closed, or tilted. Damage to the motor or system components could occur.***

### **CAUTION**

***Make sure the sunroof is fully closed when leaving your vehicle. If the sunroof is opened, rain or snow may leak through the sunroof and wet the interior as well as cause theft.***

## Sunroof open warning (if equipped)

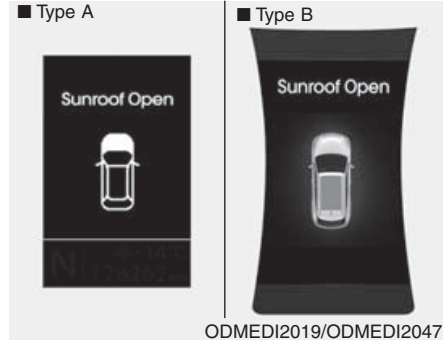

ODMEDI2019/ODMEDI2047

If the driver removes the ignition key (smart key: turns off the engine) and opens the driver-side door when the sunroof is not fully closed, the warning chime will sound for approximately 7 seconds and a message “Sunroof Open” will appear on the LCD display. Close the sunroof securely when leaving your vehicle.

**⚠ WARNING**

- Never adjust the sunroof or sunshade while driving. This could result in loss of control and an accident that may cause death, serious injury, or property damage.
- If you would like to carry items on the roof using a cross bar, do not operate the sunroof.
- When carrying cargo on the roof, do not load heavy items above the sunroof or glass roof.
- Do not allow children to operate the sunroof.

**⚠ CAUTION**

*Do not extend any luggage out side the sunroof while driving.*

**Sunshade**

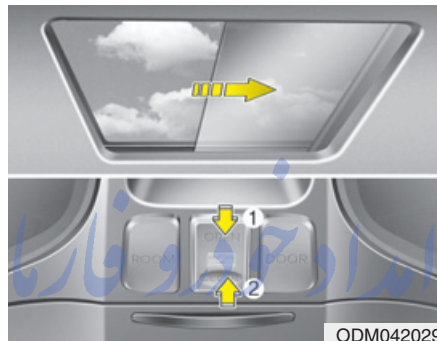

*To open the sunshade*

Press the sunshade open button (1).

*To close the sunshade when the sunroof glass is closed*

- Press the sunshade close button (2).
  - \* When you press the sunshade close button (2) with the sunroof glass opened, the sunshade will be closed halfway.
- Push the sunroof control lever forward or pull it down.

To stop the sliding at any point, press the sunshade control switch momentarily.

**\* NOTICE**

Wrinkles formed on the sunshade as material characteristic are normal.

**⚠ CAUTION**

- Do not pull or push the sunshade by hand. It could cause sunshade failure.
- Close the sunroof when driving through dusty roads. Dust may cause a malfunction of the vehicle system.

## Sliding the sunroof

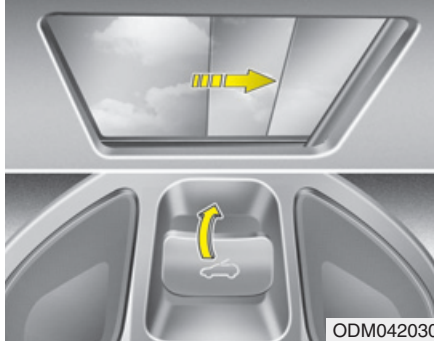

### *When the sunshade is closed*

If you pull the sunroof control lever backward, the sunshade and sunroof glass will slide all the way open. To stop the sunroof movement at any point, pull or push the sunroof control lever momentarily.

### *When the sunshade is opened*

If you pull the sunroof control lever backward, the sunroof glass will slide all the way open. To stop the sunroof movement at any point, pull or push the sunroof control lever momentarily.

\* The front part of the sunroof glass can only be opened and closed.

امداد خودرو فارما

تلفن شبانه روزی: ۰۲۱-۸۸۸۶۲۰۸۵

FarmaSOS.com

## Tilting the sunroof

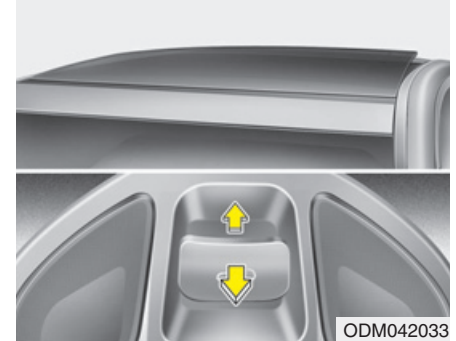

### *When the sunshade is closed*

If you push the sunroof control lever upward, the sunshade will slide halfway open then the sunroof glass will tilt.

To stop the sunroof movement at any point, pull or push the sunroof control lever momentarily.

### *When the sunshade is opened*

If you push the sunroof control lever upward, the sunroof glass will tilt.

To stop the sunroof movement at any point, pull or push the sunroof control lever momentarily.

### Closing the sunroof

#### *To close the sunroof glass with the sunshade*

Push the sunroof control lever forward or downward. The sunroof glass sunshade will close automatically.

To stop the sunroof movement at any point, pull or push the sunroof control lever momentarily.

#### *Automatic reversal*

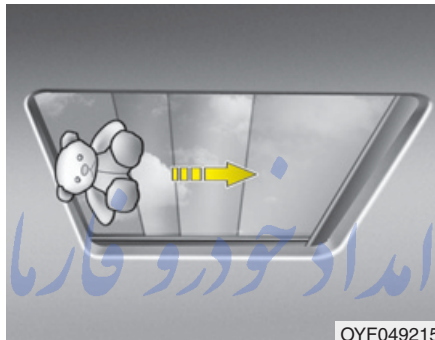

If an object or part of the body is detected while the sunroof glass or sunshade is closing automatically, it will reverse the direction, and then stop.

The auto reverse function does not work if a tiny obstacle is between the sliding glass or sunshade and the sunroof sash. You should always check that all passengers and objects are away from the sunroof before closing it.

#### **⚠ WARNING - Sunroof**

- Be careful that no head, hands and body parts are obstructed by a closing sunroof.
- Do not extend the face, neck, arms or body outside the sunroof while driving.
- Make sure your hands and head are safely out of the way before closing a sunroof.

#### **⚠ CAUTION**

- *Periodically remove any dirt that may accumulate on the guide rail.*
- *If you try to open the sunroof when the temperature is below freezing or when the sunroof is covered with snow or ice, the glass or the motor could be damaged.*

## Resetting the sunroof

Whenever the vehicle battery is disconnected or discharged, you must reset your sunroof system as follows:

1. Turn the ignition switch to the ON position.
2. Close the sunshade and sunroof completely if opened.
3. Release the sunroof control lever.
4. Push the sunroof control lever forward in the direction of close (about 10 seconds) until the sunroof moves a little. Then, release the lever.

5. Push the sunroof control lever forward in the direction of close, until the sunroof operates as follows again:

The sunshade and sunroof glass slide open → The sunroof glass slide close → The sunshade close

Then, release the lever.

When this is complete, the sunroof system has been reset.

تلفن شبانه روزی: ۰۲۱-۸۸۸۶۲۰۸۵  
\* **NOTICE**

**If you do not reset the sunroof, it may not work properly.**

FarmaSOS.com

## STEERING WHEEL

### Electronic power steering (if equipped)

Power steering uses the motor to assist you in steering the vehicle. If the engine is off or if the power steering system becomes inoperative, the vehicle may still be steered, but it will require increased steering effort.

The motor driven power steering is controlled by the power steering control unit which senses the steering wheel torque and vehicle speed to command the motor.

The steering wheel becomes heavier as the vehicle's speed increases and becomes lighter as the vehicle's speed decreases for better control of the steering wheel.

Should you notice any change in the effort required to steer during normal vehicle operation, we recommend that the system be checked by authorized HYUNDAI dealer.

### \* NOTICE

The following symptoms may occur during normal vehicle operation:

- The EPS warning light does not illuminate.
- The steering effort is high immediately after turning the ignition switch on. This happens as the system performs the EPS system diagnostics. When the diagnostics is completed, the steering wheel will return to its normal condition.
- A click noise may be heard from the EPS relay after the ignition switch is turned to the ON or LOCK/OFF position.
- Motor noise may be heard when the vehicle is at a stop or at a low driving speed.
- The steering effort increases if the steering wheel is rotated continuously when the vehicle is not in motion. However, after a few minutes, it will return to its normal conditions.

(Continued)

- If the Electronic Power Steering System does not operate normally, the warning light will illuminate on the instrument cluster. The steering wheel may become difficult to control or operate abnormally. We recommend that you contact an authorized HYUNDAI dealer.
- When you operate the steering wheel in low temperature, abnormal noise could occur. If temperature rises, the noise will disappear. This is a normal condition.

(Continued)

## Power steering (if equipped)

Power steering uses energy from the engine to assist you in steering the vehicle. If the engine is off or if the power steering system becomes inoperative, the vehicle may still be steered, but it will require increased steering effort.

Should you notice any change in the effort required to steer during normal vehicle operation, we recommend that the system be checked by an authorized HYUNDAI dealer.

### CAUTION

***Never hold the steering wheel against a stop (extreme right or left turn) for more than 5 seconds with the engine running. Holding the steering wheel for more than 5 seconds in either position may cause damage to the power steering pump.***

## \* NOTICE

**If the power steering drive belt breaks or if the power steering pump malfunctions, the steering effort will greatly increase.**

## \* NOTICE

**If the vehicle is parked for extended periods outside in cold weather (below -10°C/14°F), the power steering may require increased effort when the engine is first started. This is caused by increased fluid viscosity due to the cold weather and does not indicate a malfunction.**

**When this happens, increase the engine RPM by depressing accelerator until the RPM reaches 1,500 rpm then release or let the engine idle for two or three minutes to warm up the fluid.**

## Tilt steering

A tilt steering wheel allows you to adjust the steering wheel before you drive. You can also raise it to give your legs more room when you exit and enter the vehicle.

The steering wheel should be positioned so that it is comfortable for you to drive, while permitting you to see the instrument panel warning lights and gauges.

### WARNING

- **Never adjust the angle and height of steering wheel while driving. You may lose your steering control and cause severe personal injury or accidents.**
- **After adjusting, push the steering wheel both up and down to be certain it is locked in position.**



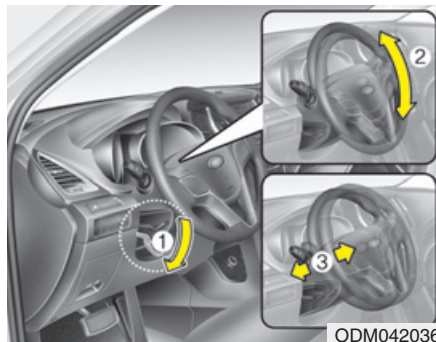

To change the steering wheel angle, pull down the lock release lever (1), adjust the steering wheel to the desired angle (2) and height (3), then pull up the lock-release lever to lock the steering wheel in place. Be sure to adjust the steering wheel to the desired position before driving.

### Heated steering wheel (if equipped)

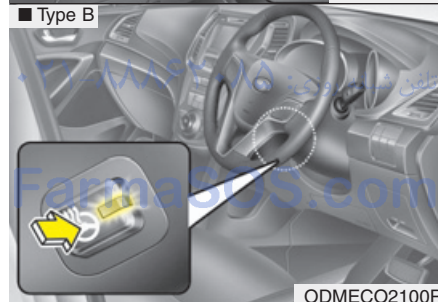
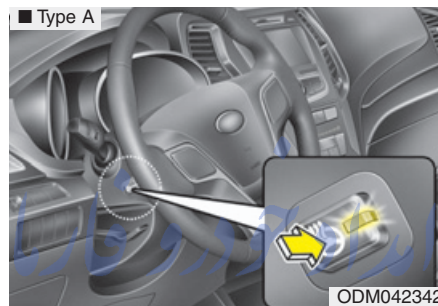

With the ignition switch in the ON position, pressing the heated steering wheel button warms the steering wheel. The indicator on the button will illuminate and notify you on the LCD display.

To turn the heated steering wheel off, press the button once again. The indicator on the button will turn off and notify you on the LCD display.

### \* NOTICE

The heated steering wheel will turn off automatically approximately 30 minutes after the heated steering wheel is turned on.

### ⚠ CAUTION

***Do not install any grip to operate the steering wheel. This causes damage to the heated steering wheel system.***

**Horn**

To sound the horn, press the horn symbol on your steering wheel.  
Check the horn regularly to be sure it operates properly.

**\* NOTICE**

To sound the horn, press the area indicated by the horn symbol on your steering wheel (see illustration). The horn will operate only when this area is pressed.

**⚠ CAUTION**

*Do not strike the horn severely to operate it, or hit it with your fist. Do not press on the horn with a sharp-pointed object.*

امداد خودرو فارما

تلفن شبانه روزی: ۰۲۱-۸۸۸۶۲۰۸۵

FarmaSOS.com

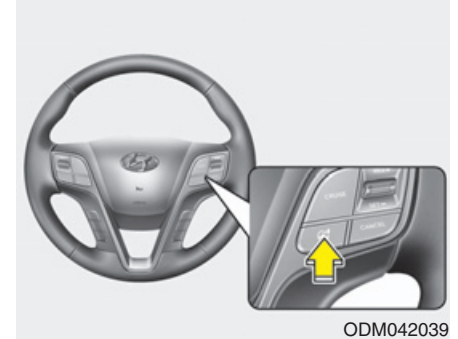
**Flex steering wheel  
(if equipped)**

The flex steering wheel controls steering effort as driver's preference or road condition.

You can select the desired steering mode by pressing the steering mode button.

When the steering mode button is pressed, the selected steering mode will appear on the LCD display.

If the steering mode button is pressed within 4 seconds, the steering mode will change as above pictures.

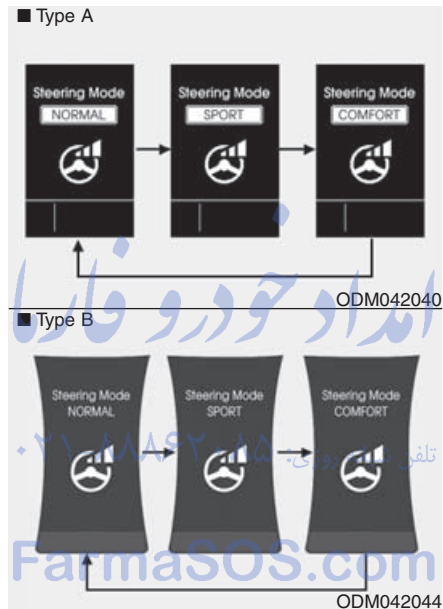

If the steering wheel mode button is not pressed for about 4 seconds, the LCD display will change to the previous screen.

### Normal mode



The normal mode offers medium steering effort.

**Comfort mode**

## ■ Type A



ODM042042

## ■ Type B



ODM042046

The steering wheel becomes lighter. The comfort mode is usually used when driving in downtown or parking the vehicle.

Also, the comfort mode helps weak people to drive easily.

**Sport mode**

## ■ Type A

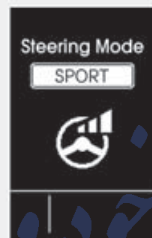

ODM042043

## ■ Type B



ODM042047

The steering wheel becomes heavier. The sport mode is usually used when driving in highway.

**CAUTION**

- For your safety, if you press the steering mode button while operating the steering wheel, the LCD display will change, but the steering effort will not change immediately. After operating the steering wheel, the steering effort will change automatically to the selected mode.
- Be careful when changing the steering mode while driving.
- When the electronic power steering is not working properly, the flex steering wheel will not work.

## MIRRORS

### Inside rearview mirror

Adjust the rearview mirror so that the center view through the rear window is seen. Make this adjustment before you start driving.

**⚠ WARNING - Rear visibility**  
Do not place objects in the rear seat or cargo area which would interfere with your vision out the rear window.

**⚠ WARNING**  
Do not adjust the rearview mirror while the vehicle is moving. This could result in loss of control, and an accident which could cause death, serious injury or property damage.

**⚠ WARNING**  
Do not modify the inside mirror and do not install a wide mirror. It could result in injury, during an accident or deployment of the air bag.

### Day/night rearview mirror (if equipped)

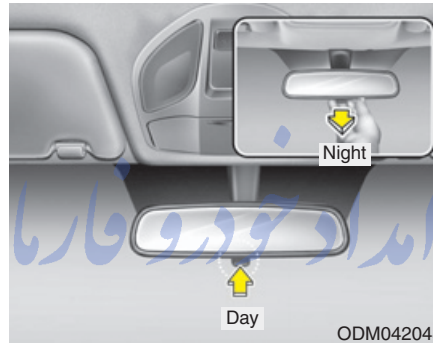

Make this adjustment before you start driving and while the day/night lever is in the day position.

Pull the day/night lever toward you to reduce glare from the headlights of vehicles behind you during night driving.

*Remember that you lose some rearview clarity in the night position.*

### Electric chromic mirror (ECM) (if equipped)

The electric rearview mirror automatically controls the glare from the headlights of the car behind you in nighttime or low light driving conditions. The sensor mounted in the mirror senses the light level around the vehicle, and automatically controls the headlight glare from vehicles behind you.

When the engine is running, the glare is automatically controlled by the sensor mounted in the rearview mirror.

Whenever the shift lever is shifted into R (Reverse), the mirror will automatically go to the brightest setting in order to improve the drivers view behind the vehicle.

**⚠ CAUTION**  
*When cleaning the mirror, use a paper towel or similar material dampened with glass cleaner. Do not spray glass cleaner directly on the mirror as that may cause the liquid cleaner to enter the mirror housing.*

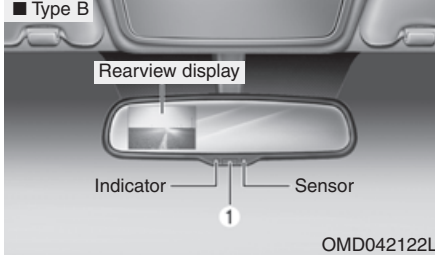
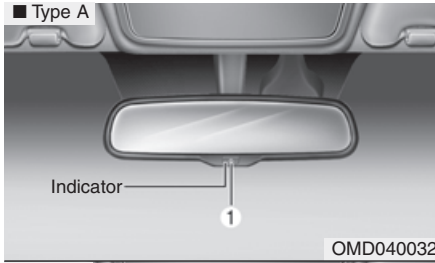

**To operate the electric rearview mirror:**

- Press the on/off button (1) to turn the automatic dimming function on. The mirror indicator light will illuminate.
- Press the on/off button to turn the automatic dimming function off. The mirror indicator light will turn off.
- The mirror defaults to the ON position whenever the ignition switch is turned on.

**Electric chromic mirror (ECM) with compass**



1. Rear light sensor
2. Status indicator LED
3. ECM ON/OFF button
4. Compass button
5. Display window

Automatic dimming rear view mirror controls automatically the glare of headlights of the vehicle behind you when it turned on by pressing the ECM ON/OFF button. It is turned off by pressing the ECM ON/OFF button once more.

**1. To operate Compass feature**

Press and release the compass button, then the vehicle's directional heading will be displayed. Pressing and releasing the button again will turn off the display.

**Heading display**

- E : East
- W : West
- S : South
- N : North
- ex) NE : North East

### 2. Calibration procedure

Press and hold the button for more than 6 but less than 9 seconds. When the compass memory is cleared a "C" will appear in the display.

- Driving the vehicle in a circle at less than 8km/h 2 times or until the compass heading appears.
- Driving in a circle in right-handed direction and opposite direction are possible, and if the calibration is completed, the compass heading will appear.
- Keep driving in a circle until a compass heading appears.

### 3. Setting the compass zone

1. Find your current location and variance zone number on the zone map.

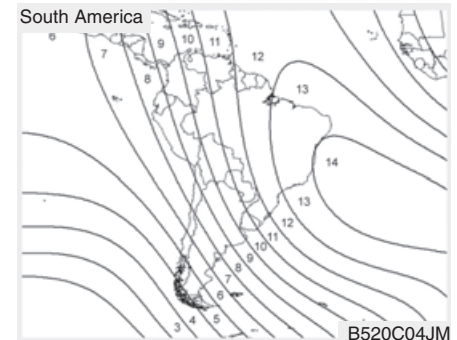
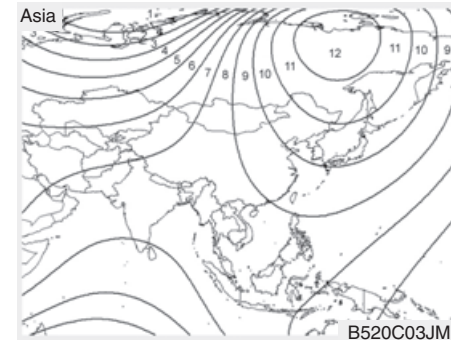
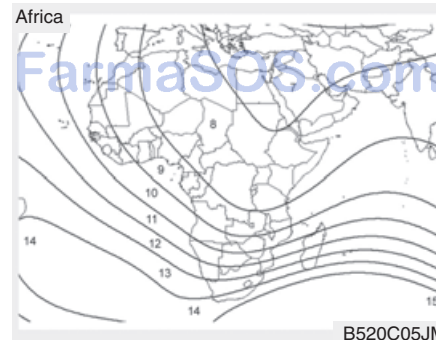
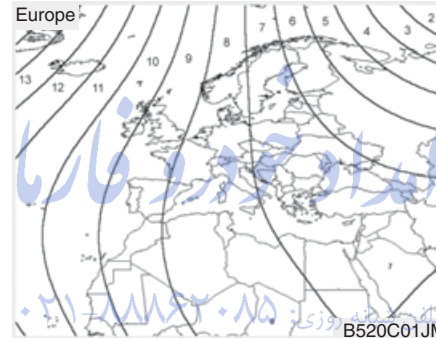

2. Press and hold the button for more than 3 but less than 6 seconds. The current zone number will appear in the display.

3. Press the button until the new zone number appears in the display. After you stop pressing the button in, the display will show a compass direction within a few seconds.

 **CAUTION**

- 1. Do not install the ski rack, antenna, etc. which are attached to the vehicle by means of a magnet. They affect the operation of the compass.*
- 2. If the compass deviates from the correct indication soon after repeated adjustment, we recommend that you have the compass checked at an authorized HYUNDAI dealer.*
- 3. The compass may not indicate the correct compass point in tunnels or while driving up or down a steep hill.  
(The compass returns to the correct compass point when the vehicle moves to an area where the geomagnetism is stabilized.)*

*(Continued)*

*(Continued)*

- 4. When cleaning the mirror, use a paper towel or similar material dampened with glass cleaner. Do not spray glass cleaner directly on the mirror as that may cause the liquid cleaner to enter the mirror housing.*



### Outside rearview mirror

Be sure to adjust mirror angles before driving.

Your vehicle is equipped with both left-hand and right-hand outside rearview mirrors. The mirrors can be adjusted remotely with the remote switch. The mirror heads can be folded back to prevent damage during an automatic car wash or when passing in a narrow street.

#### **⚠ WARNING - Rearview mirrors**

- The outside rearview mirror is convex. Objects seen in the mirror are closer than they appear.
- Use your interior rearview mirror or direct observation to determine the actual distance of following vehicles when changing lanes.

#### **⚠ CAUTION**

*Do not scrape ice off the mirror face; this may damage the surface of the glass. If ice should restrict movement of the mirror, do not force the mirror for adjustment. To remove ice, use a deicer spray, or a sponge or soft cloth with very warm water.*

#### **⚠ CAUTION**

*If the mirror is jammed with ice, do not adjust the mirror by force. Use an approved spray de-icer (not radiator antifreeze) to release the frozen mechanism or move the vehicle to a warm place and allow the ice to melt.*

#### **⚠ WARNING**

**Do not adjust or fold the outside rearview mirrors while the vehicle is moving. This could result in loss of control, and an accident which could cause death, serious injury or property damage.**

**Remote control**

ODM042052

**Electric type**

The electric remote control mirror switch allows you to adjust the position of the left and right outside rearview mirrors. To adjust the position of either mirror, move the lever (1) to R (Right) or L (Left) to select the right side mirror or the left side mirror, then press a corresponding point on the mirror adjustment control to position the selected mirror up, down, left or right.

After adjustment, put the lever into neutral (center) position to prevent inadvertent adjustment.

**⚠ CAUTION**

- The mirrors stop moving when they reach the maximum adjusting angles, but the motor continues to operate while the switch is pressed. Do not press the switch longer than necessary, the motor may be damaged.
- Do not attempt to adjust the outside rearview mirror by hand. Doing so may damage the parts.

تلفن شبانه روزی: ۰۲۱-۸۸۸۶۲۰۸۵

FarmaSOS.com

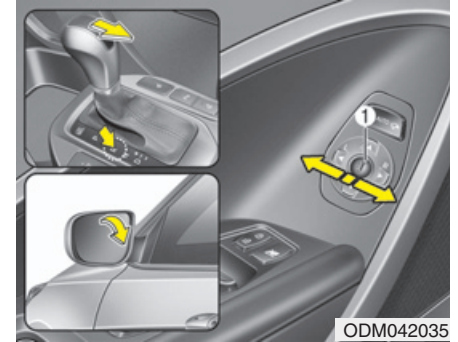
**Reverse parking aid function  
(if equipped)**

ODM042035

When you shift the shift lever to the R (Reverse) position, the outside rearview mirror(s) will move downward to aid reverse parking. According to the position of the outside rearview mirror control switch (1), the outside rearview mirror(s) will operate as follows:

**Left or Right :** When the outside rearview mirror control switch is in the L (Left) or R (Right) position, both outside rearview mirrors will move downward.

**Neutral :** When the outside rearview mirror control switch is in the neutral (center) position, the outside rearview mirrors will not operate.

### \* NOTICE

The outside rearview mirrors will automatically revert to their original positions under the following conditions:

- When the ignition switch or engine start/stop button is set to the ACC or OFF position.
- When the shift lever is moved to any position except the R (Reverse) position.

### Folding the outside rearview mirror

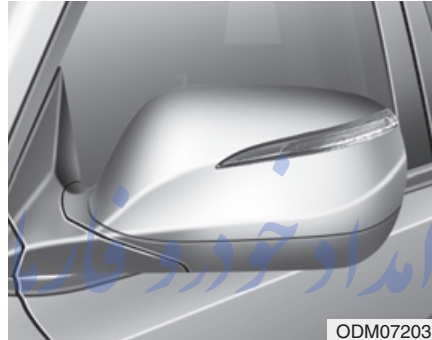

#### Manual type

To fold outside rearview mirror, grasp the housing of mirror and then fold it toward the rear of the vehicle.

FarmaSOS.com



#### Electric type

The outside rearview mirror can be folded or unfolded by pressing the switch as below.

**Left (1) :** The mirror will unfold.

**Right (2) :** The mirror will fold.

**Center (AUTO, 3) :**

The mirror will fold or unfold automatically as follows:

- Without smart key system
  - The mirror will fold or unfold when the door is locked or unlocked by the transmitter.

- With smart key system
  - The mirror will fold or unfold when the door is locked or unlocked by the smart key.
  - The mirror will fold or unfold when the door is locked or unlocked by the button on the outside door handle.
  - The mirror will unfold when you approach the vehicle (all doors closed and locked) with a smart key in possession. (if equipped)

 **CAUTION**

*The electric type outside rearview mirror operates even though the ignition switch is in the OFF position. However, to prevent unnecessary battery discharge, do not adjust the mirrors longer than necessary while the engine is not running.*

 **CAUTION**

*In case it is an electric type outside rearview mirror, don't fold it by hand. It could cause motor failure.*

FarmaSOS.com

## INSTRUMENT CLUSTER

### ■ Type A

- Gasoline engine



1. Tachometer
2. Speedometer
3. Engine coolant temperature gauge
4. Fuel gauge
5. LCD display
6. Warning and indicator lights (if equipped)
7. Turn signal indicator lights

- Diesel engine



\* The actual cluster in the vehicle may differ from the illustration.  
For more details, refer to the "Gauges" in this chapter.

ODMEMM2346/ODMEMM2054

■ Type B  
- Gasoline engine



1. Tachometer
2. Speedometer
3. Engine coolant temperature gauge
4. Fuel gauge
5. LCD display
6. Warning and indicator lights (if equipped)
7. Turn signal indicator lights

- Diesel engine

تلفن شبانه روزی: ۰۲۱-۸۸۶۲۰۸۵



- \* The actual cluster in the vehicle may differ from the illustration.  
For more details, refer to the "Gauges" in this chapter.

ODMEMM2347/ODMEMM2055

## Instrument Cluster Control

### **⚠ WARNING**

Never adjust the instrument cluster while driving. This could result in loss of control and lead to an accident that may cause death, serious injury, or property damage.

### *Adjusting Instrument Cluster Illumination (if equipped)*

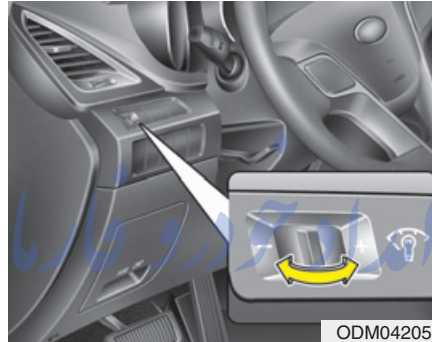

The brightness of the instrument panel illumination is changed by moving the illumination control knob right or left when the ignition switch or Engine Start/Stop button is ON, or the tail lights are turned on.

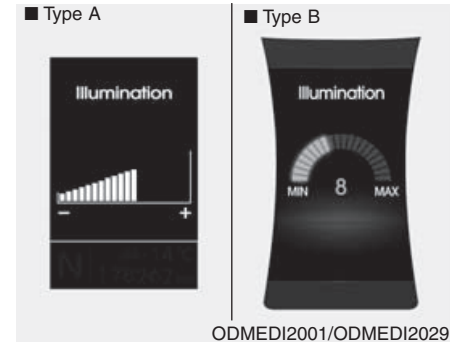

- The brightness has 20 levels : 1 (MIN) ~ 20 (MAX)
- If you hold the illumination control knob on the right end (+) or left end (-), the brightness will be changed continuously.
- If the brightness reaches to the maximum or minimum level, an alarm will sound.

## LCD Display Control



ODM042224

The LCD display modes can be changed by using the control buttons on the steering wheel.

- (1) : MODE button for changing modes
- (2) : MOVE button for changing items
- (3) : SELECT/RESET button for setting or resetting the selected item

\* For the LCD modes, refer to “LCD Display” in this chapter.

## Gauges

### Speedometer

■ Type A (km/h)



■ Type B (km/h)



■ Type A (MPH)



■ Type B (MPH)



ODM042057/ODMNMM2057/ODM042058/ODMNMM2058

The speedometer indicates the speed of the vehicle and is calibrated in miles per hour (mph) and/or kilometers per hour (km/h).



## Tachometer

■ Type A (Gasoline)



■ Type B (Gasoline)



■ Type A (Diesel)



■ Type B (Diesel)



The tachometer indicates the approximate number of engine revolutions per minute (rpm).

Use the tachometer to select the correct shift points and to prevent lugging and/or over-revving the engine.

 **CAUTION**

***Do not operate the engine within the tachometer's RED ZONE. This may cause severe engine damage.***

ODMNMM2059/ODM042059/ODMNMM2221/ODM042221

### Engine Coolant Temperature Gauge

■ Type A

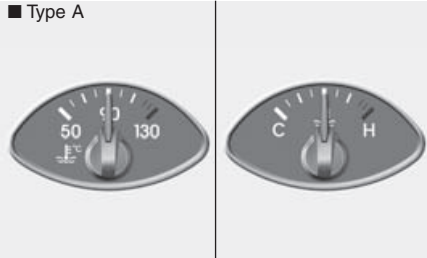

ODMEMM2222/ODMNMM2222

■ Type B

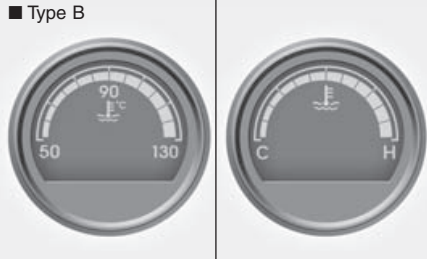

ODMEMM2352/ODMNMM2352

This gauge indicates the temperature of the engine coolant when the ignition switch or Engine Start/Stop button is ON.

### ⚠ CAUTION

*If the gauge pointer moves beyond the normal range area toward the “130 or H” position, it indicates overheating that may damage the engine.*

*Do not continue driving with an overheated engine. If your vehicle overheats, refer to “If the Engine Overheats” in chapter 6.*

### ⚠ WARNING

**Never remove the radiator cap when the engine is hot. The engine coolant is under pressure and could cause severe burns. Wait until the engine is cool before adding coolant to the reservoir.**

### Fuel Gauge

■ Type A



ODMEMM2223/ODMNMM2223

■ Type B

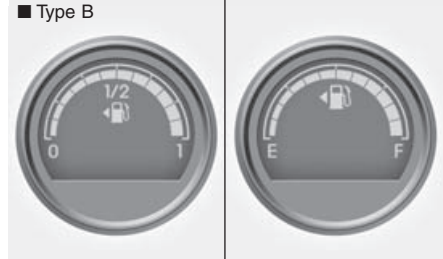

ODMEMM2351/ODMNMM2351

This gauge indicates the approximate amount of fuel remaining in the fuel tank.

### \* NOTICE

- The fuel tank capacity is given in chapter 8.
- The fuel gauge is supplemented by a low fuel warning light, which will illuminate when the fuel tank is nearly empty.
- On inclines or curves, the fuel gauge pointer may fluctuate or the low fuel warning light may come on earlier than usual due to the movement of fuel in the tank.

**⚠ WARNING - Fuel Gauge**  
Running out of fuel can expose vehicle occupants to danger.  
You must stop and obtain additional fuel as soon as possible after the warning light comes on or when the gauge indicator comes close to the "0 or E (Empty)" level.

**⚠ CAUTION**  
*Avoid driving with a extremely low fuel level. Running out of fuel could cause the engine to misfire damaging the catalytic converter.*

FarmaSOS.com

### Odometer

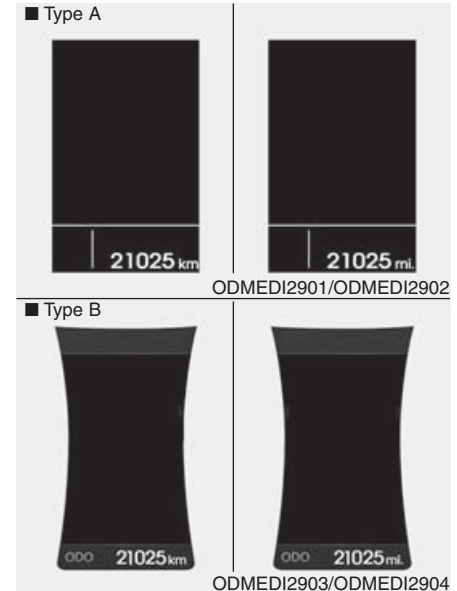

The odometer Indicates the total distance that the vehicle has been driven and should be used to determine when periodic maintenance should be performed.

- Odometer range : 0 ~ 999999 kilometers or miles.

### Outside Temperature Gauge

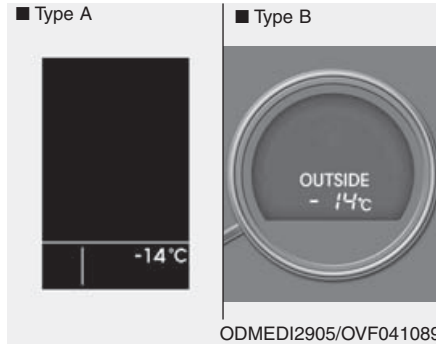

This gauge indicates the current outside air temperatures by 1°C (1°F).

- Temperature range : -40°C ~ 60°C (-40°F ~ 140°F)

The outside temperature on the display may not change immediately like a general thermometer to prevent the driver from being inattentive.

The temperature unit (from °C to °F or from °F to °C) can be changed by using the “User Settings” mode of the LCD display.

\* For more details, refer to “LCD Display” in this chapter.

### Icy Road Warning Light (if equipped)

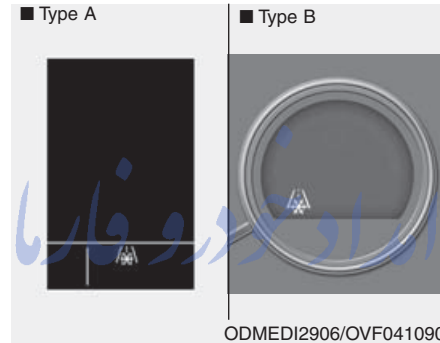

This warning light is to warn the driver the road may be icy.

When the following conditions occur, the warning light (including Outside Temperature Gauge) blinks 10 times and then illuminates, and also warning chime sounds 3 times.

- The temperature on the Outside Temperature Gauge is below approximately 4°C (39.2°F)
- The ignition switch or Engine Start/Stop button is ON

### \* NOTICE

If the icy road warning light appears while driving, you should drive more attentively and safely refraining from over-speeding, rapid acceleration, sudden braking or sharp turning, etc.

## Transaxle Shift Indicator

### Automatic Transaxle Shift Indicator (if equipped)



This indicator displays which automatic transaxle shift lever is selected.

- Park : P
- Reverse : R
- Neutral : N
- Drive : D
- Sports Mode : 1, 2, 3, 4, 5, 6

### Automatic Transaxle Shift Indicator (if equipped, For Europe)



In the Sports Mode, this indicator informs which gear is desired while driving to save fuel.

- Shifting up : ▲2, ▲3, ▲4, ▲5, ▲6
- Shifting down : ▼1, ▼2, ▼3, ▼4, ▼5

For example

- ▲3: Indicates that shifting up to the 3rd gear is desired (currently the shift lever is in the 2nd or 1st gear).
- ▼3: Indicates that shifting down to the 3rd gear is desired (currently the shift lever is in the 4th, 5th, or 6th gear).

When the system is not working properly, the indicator is not displayed.

### Manual Transaxle Shift Indicator (if equipped)

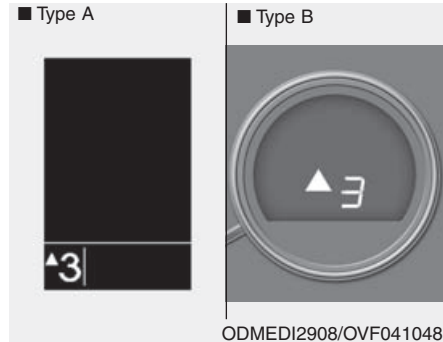

This indicator informs which gear is desired while driving to save fuel.

- Shifting up : ▲2, ▲3, ▲4, ▲5, ▲6
- Shifting down : ▼1, ▼2, ▼3, ▼4, ▼5

For example

- ▲3: Indicates that shifting up to the 3rd gear is desired (currently the shift lever is in the 2nd or 1st gear).
- ▼3: Indicates that shifting down to the 3rd gear is desired (currently the shift lever is in the 4th, 5th, or 6th gear).













When the system is not working properly, the indicator is not displayed.

تلفن شبانه روزی: ۰۲۱-۸۸۸۶۲۰۸۵

FarmaSOS.com

## LCD DISPLAY

### LCD Modes

Modes	Symbol		Explanation
	Type A	Type B	
Trip Computer			This mode displays driving information like the tripmeter, fuel economy, and so on. For more details, refer to "Trip Computer" in this chapter.
Service	 or 	 or 	This mode informs of service interval (mileage or days) and warning messages related to TPMS, washer fluid, or active hood lift system.
User Settings			On this mode, you can change settings of the doors, lamps, and so on.
LDWS (if equipped)	-	 or 	This mode displays the state of the Lane Departure Warning System (LDWS). For more details, refer to "Lane Departure Warning System (LDWS)" in chapter 5.
A/V (if equipped)	-		This mode displays the state of the A/V system.
Turn By Turn (if equipped)	-		This mode displays the state of the navigation.

✳ For controlling the LCD modes, refer to "LCD Display Control" in this chapter.

## Service Mode

### Service Interval

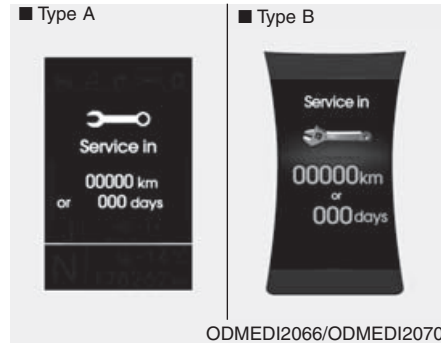

### Service in

It calculates and displays when you need a scheduled maintenance service (mileage or days).



If the remaining mileage or time reaches 1,500 km (900 mi.) or 30 days, "Service in" message is displayed for several seconds each time you set the ignition switch or Engine Start/Stop Button to the ON position.



### Service required

If you do not have your vehicle serviced according to the already inputted service interval, "Service required" message is displayed for several seconds each time you set the ignition switch or Engine Start/Stop Button to the ON position. (The mileage and time changes to "---")

To reset the service interval to the mileage and days you inputted before:

- Activate the reset mode by pressing the SELECT/RESET button  for more than 5 seconds, then press the SELECT/RESET button  again for more than 1 second (Europe).
- Press the SELECT/RESET button  for more than 1 second (Except Europe).

تلفن شبانه روزی: ۰۲۱-۸۸۴۲۰۸۵



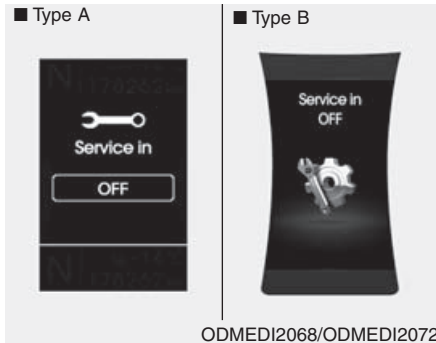

### Service in OFF

If the service interval is not set, "Service in OFF" message is displayed on the LCD display.

### \* NOTICE

If any of the following conditions occurs, the mileage and days may be incorrect.

- The battery cable is disconnected.
- The fuse switch is turned off.
- The battery is discharged.

## User Settings Mode

### Description

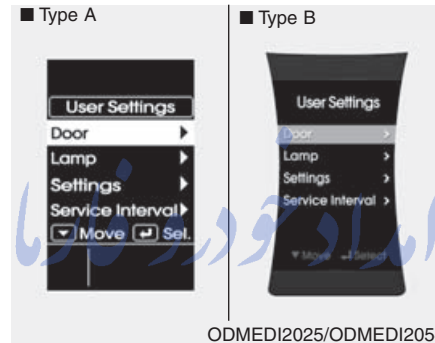

On this mode, you can change setting of the doors, lamps, and so on.

## Door

### Auto Door Lock (if equipped)

- Off:  
The auto door lock operation will be deactivated.
- Speed:  
All doors will be automatically locked when the vehicle speed exceeds 15km/h (9.3mph).
- Shift Lever:  
All doors will be automatically locked if the automatic transaxle shift lever is shifted from the P (Park) position to the R (Reverse), N (Neutral), or D (Drive) position.

FarmaSOS.com

**Auto Door Unlock (if equipped)**

- Off:  
The auto door unlock operation will be canceled.
- Key Out or Power Off:  
All doors will be automatically unlocked when the ignition key is removed from ignition switch or Engine Star/Stop Button is set to the OFF position.
- Driver Door Unlock:  
All doors will be automatically unlocked if the driver's door is unlocked.
- Shift Lever:  
All doors will be automatically unlocked if the automatic transaxle shift lever is shifted to the P (Park) position.

**Horn Feedback (if equipped)**

If this item is checked, the horn feedback operation will be activated. After locking the door by pressing the lock button on the transmitter, if you press the lock button again within 4 seconds, the warning sound will operate once to indicate that all doors are locked.

امداد خودرو فارما

تلفن شبانه روزی: ۰۲۱-۸۸۸۶۲۰۸۵

FarmaSOS.com

**Lamp****Head Lamp Delay (if equipped)**

If this item is checked, the headlamp delay and headlamp welcome function will be activated.

**Welcome Light (if equipped)**

If this item is checked, the welcome light function of the puddle lamp will be activated.

**Auto Triple Turn (One-touch triple turn signal) (if equipped)**

If this item is checked, the lane change signals will blink 3 times when the turn signal lever is moved slightly.

**Travel Mode (if equipped)**

If this item is checked, the traffic change function will be activated.

For more details, refer to "Lighting" in this chapter.

### Settings

#### Language (if equipped)

Choose the language you prefer within the LCD display.

#### Temperature Unit

Convert the temperature unit from °C to °F or from °F to °C.

#### Welcome Sound

If this item is checked, the welcome sound function will be activated.

#### Shift Indicator (if equipped)

If this item is checked, the shift indicator function will be activated.

For more details, refer to “Instrument Cluster” in this chapter.

#### Seat Easy Access (if equipped)

If this item is checked, the driver's seat will automatically move forward or rearward for the driver to enter or exit the vehicle comfortably.

#### AVG Fuel Eco Reset

- Auto Reset:  
The average fuel economy will reset automatically when refueling.
- Manual Reset:  
The average fuel economy will not reset automatically whenever refueling.

For more details, refer to “Trip Computer” in this chapter.

آراد خودرو ساز

تلفن شبانه روزی: ۰۲۱-۸۸۸۶۲۰۸۵

FarmaSOS.com

#### Service Interval (Except Europe)

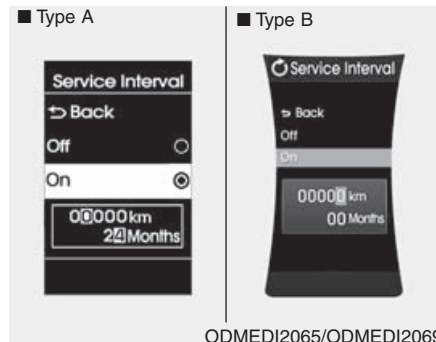

On this mode, you can activate the service interval function with mileage (km or mi.) and period (months).

#### \* NOTICE

If it is not available to set service interval on your vehicle, we recommend that you consult an authorized HYUNDAI dealer.

### A/V Mode (if equipped)

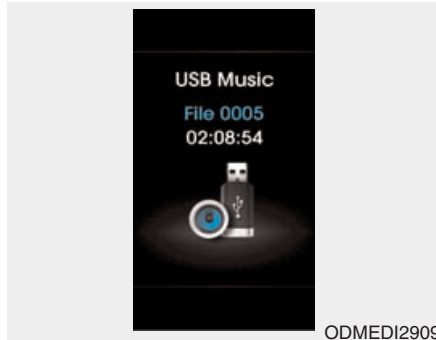

This mode displays the state of the A/V system.

### Turn By Turn Mode (if equipped)



This mode displays the state of the navigation. [www.farmasos.com](http://www.farmasos.com) تلفن شبانه روزی: ۰۸۵+۸۶۲

[FarmaSOS.com](http://www.farmasos.com)

## Warning Messages

**Shift to "P" position (for smart key system and automatic transaxle)**

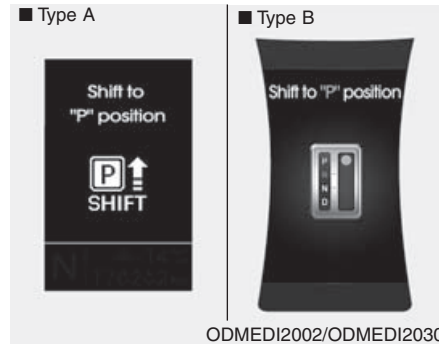

- This warning message illuminates if you try to turn off the engine without the shift lever in P (Park) position.
- At this time, the Engine Start/Stop Button turns to the ACC position (If you press the Engine Start/Stop Button once more, it will turn to the ON position).

**Low Key Battery (for smart key system)**

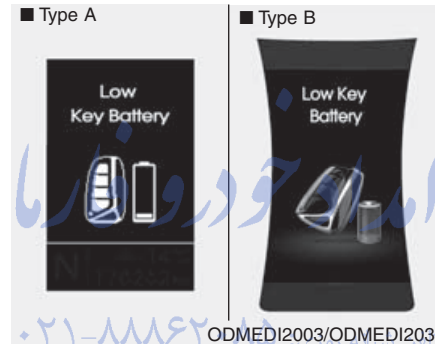

- This warning message illuminates if the battery of the smart key is discharged when the Engine Start/Stop Button changes to the OFF position.

**Press start button while turn steering (for smart key system)**

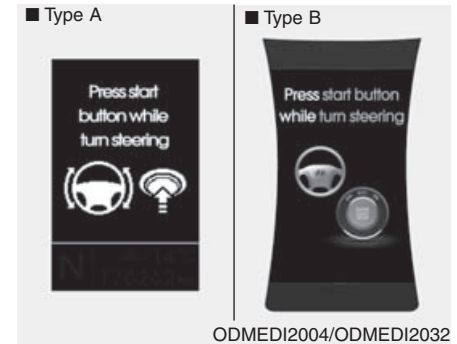

- This warning message illuminates if the steering wheel does not unlock normally when the Engine Start/Stop Button is pressed.
- It means that you should press the Engine Start/Stop Button while turning the steering wheel right and left.

**Steering wheel unlocked  
(for smart key system)**

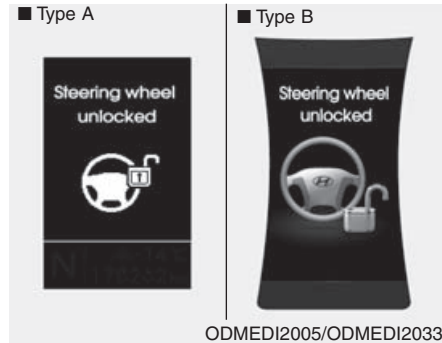

- This warning message illuminates if the steering wheel does not lock when the Engine Start/Stop Button changes to the OFF position.

**Check steering wheel lock  
system (for smart key system)**

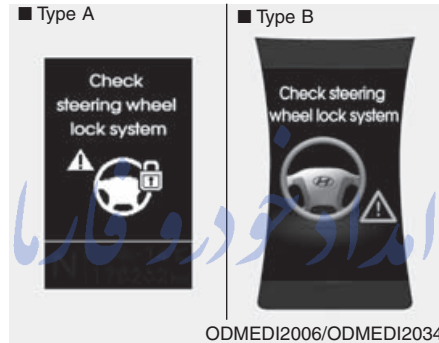

- This warning message illuminates if the steering wheel does not lock normally when the Engine Start/Stop Button changes to the OFF position.

**Press brake pedal to start engine  
(for smart key system and auto-  
matic transaxle)**

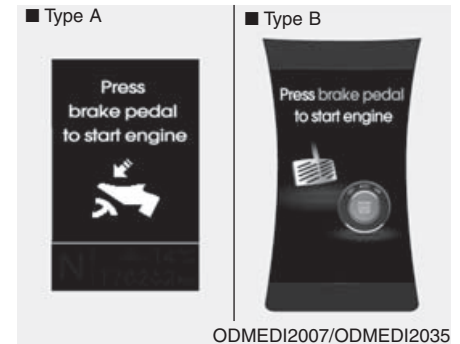

- This warning message illuminates if the Engine Start/Stop Button changes to the ACC position twice by pressing the button repeatedly without depressing the brake pedal.
- It means that you should depress the brake pedal to start the engine.

### **Press clutch pedal to start engine (for smart key system and manual transaxle)**

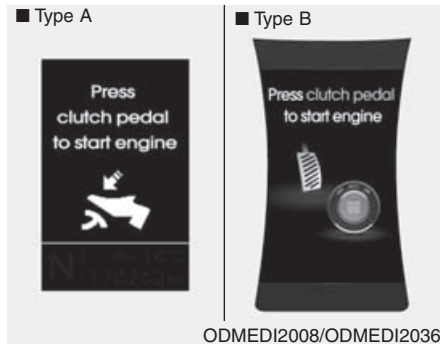

- This warning message illuminates if the Engine Start/Stop Button changes to the ACC position twice by pressing the button repeatedly without depressing the clutch pedal.
- It means that you should depress the clutch pedal to start the engine.

### **Key not in vehicle (for smart key system)**

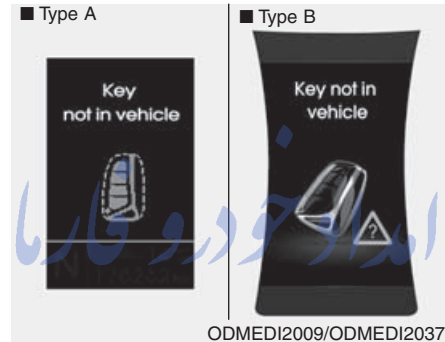

- This warning message illuminates if the smart key is not in the vehicle when you press the Engine Start/Stop Button.
- It means that you always have the smart key with you.

### **Key not detected (for smart key system)**

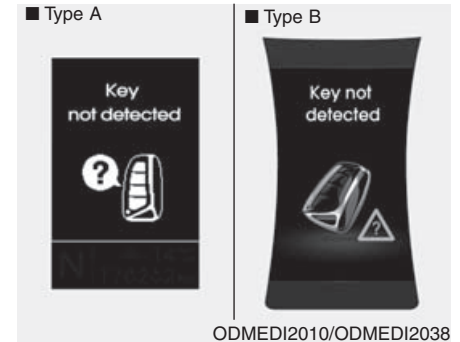

- This warning message illuminates if the smart key is not detected when you press the Engine Start/Stop Button.

**Press start button again  
(for smart key system)**

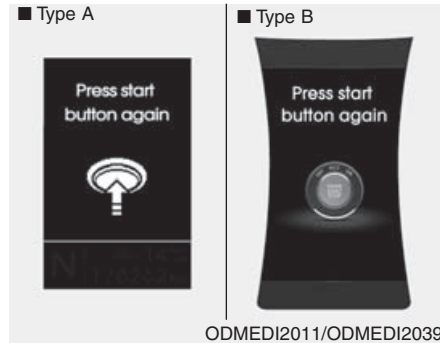

ODMEDI2011/ODMEDI2039

- This warning message illuminates if you can not operate the Engine Start/Stop Button when there is a problem with the Engine Start/Stop Button system.
- It means that you could start the engine by pressing the Engine Start/ Stop Button once more.
- If the warning illuminates each time you press the Engine Start/Stop Button, we recommend that you have the vehicle inspected by an authorized HYUNDAI dealer.

**Press start button with smart key  
(for smart key system)**

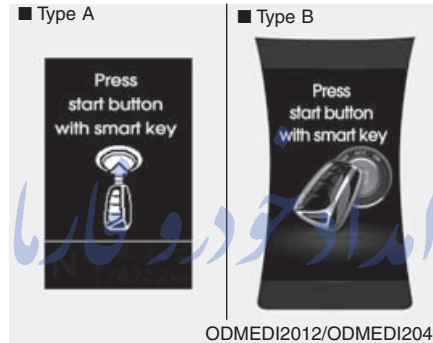

ODMEDI2012/ODMEDI2040

- This warning message illuminates if you press the Engine Start/Stop Button while the warning message "Key not detected" is illuminating.
- At this time, the immobilizer indicator light blinks.

**Check fuse "BRAKE SWITCH"  
(for smart key system and auto-  
matic transaxle)**

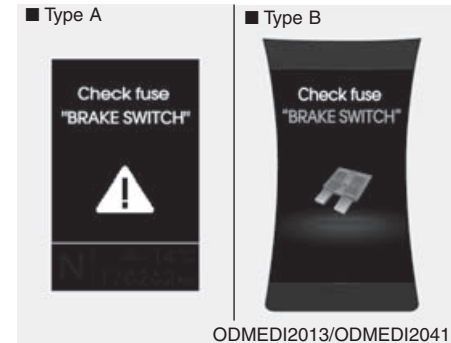

ODMEDI2013/ODMEDI2041

- This warning message illuminates if the brake switch fuse is disconnected.
- It means that you should replace the fuse with a new one. If that is not possible, you can start the engine by pressing the Engine Start/Stop Button for 10 seconds in the ACC position.



### *Shift to "P" or "N" to start engine (for smart key system and auto- matic transaxle)*

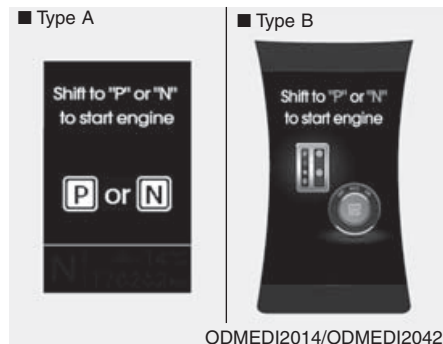

- This warning message illuminates if you try to start the engine with the shift lever not in the P (Park) or N (Neutral) position.

### \* NOTICE

You can start the engine with the shift lever in the N (Neutral) position. But, for your safety, we recommend that you start the engine with the shift lever in the P (Park) position.

### *Door Open*

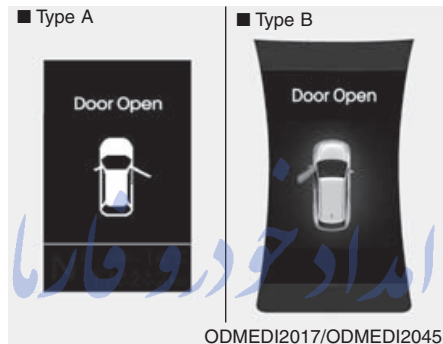

- It means that any door is open.

### *Tailgate Open*

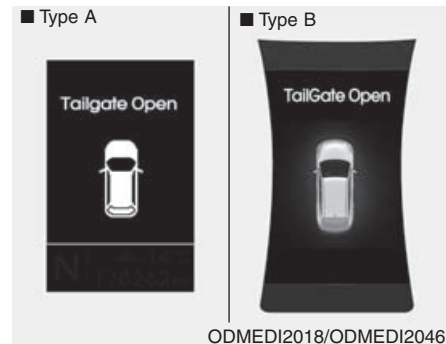

- It means that the tailgate is open.

FarmaSOS.com

**Sunroof Open (if equipped)**

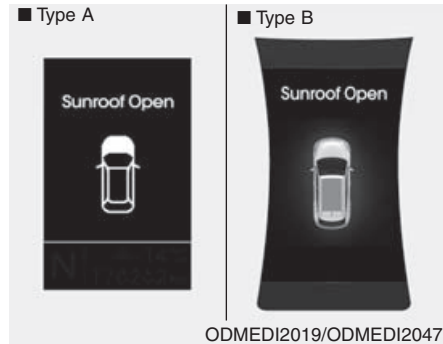

- It means that the sunroof is open.

**Align steering wheel (if equipped)**

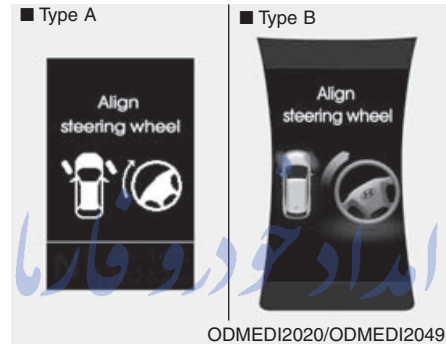

- This warning message illuminates if you start the engine when the steering wheel is turned to more than 90 degrees to the left or right.
- It means that you should turn the steering wheel and make the angle of the steering wheel be less than 30 degrees.

**Low Washer Fluid (if equipped)**

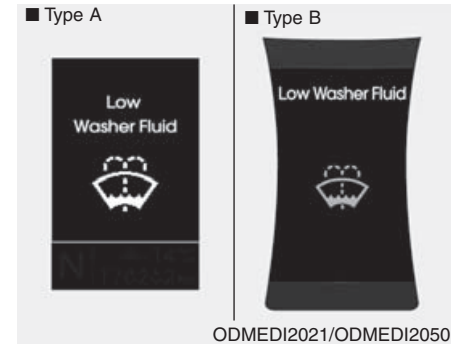

- This warning message illuminates on the service reminder mode if the washer fluid level in the reservoir is nearly empty.
- It means that you should refill the washer fluid.

### **Turn on "FUSE SWITCH" (if equipped)**

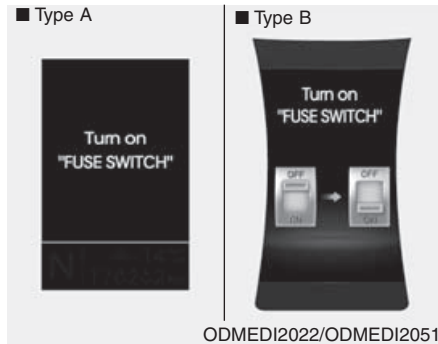

- This warning message illuminates if the fuse switch under the steering wheel is OFF.
- It means that you should turn the fuse switch on.

For more details, refer to "Fuses" in chapter 7.

### **Check Active Hood Lift System (if equipped)**

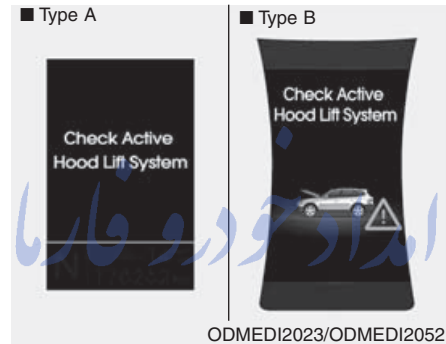

- This warning message illuminates if the active hood lift system has a malfunction.
- In this case, we recommend that you have the vehicle inspected by an authorized HYUNDAI dealer.

## TRIP COMPUTER

### Overview

#### Description

The trip computer is a microcomputer-controlled driver information system that displays information related to driving.

#### \* NOTICE

Some driving information stored in the trip computer (for example Average Vehicle Speed) resets if the battery is disconnected.

#### Trip Modes

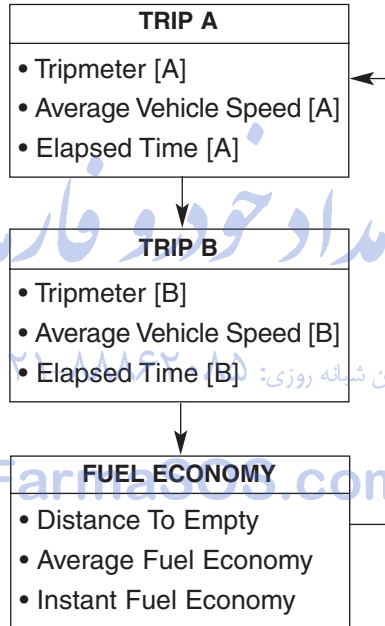

## Trip A/B

### ■ Type A

- Trip A (km, km/h)



- Trip A (mi., MPH)

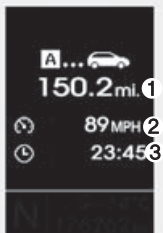

- Trip B (km, km/h)

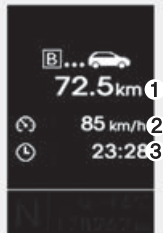

- Trip B (mi., MPH)

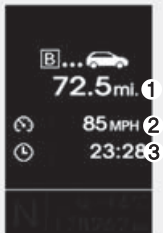

### ■ Type B

- Trip A (km, km/h)



- Trip A (mi., MPH)

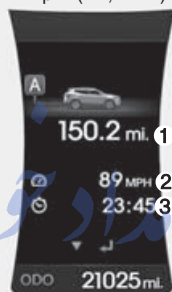

- Trip B (km, km/h)



- Trip B (mi., MPH)

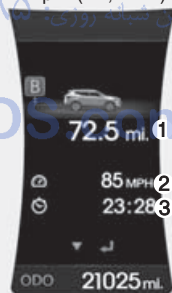

## Tripmeter (1)

- The tripmeter is the total driving distance since the last tripmeter reset.
  - Distance range: 0.0 ~ 9999.9 km or mi.
- To reset the tripmeter, press the SELECT/RESET button  on the steering wheel for more than 1 second when the tripmeter is displayed.

## Average Vehicle Speed (2)

- The average vehicle speed is calculated by the total driving distance and driving time since the last average vehicle speed reset.
  - Speed range: 0 ~ 999 km/h or MPH
- To reset the average vehicle speed, press the SELECT/RESET button  on the steering wheel for more than 1 second when the average vehicle speed is displayed.

ODMEDI2027/ODMEDI2062/ODMEDI2028/ODMEDI2063/ODMEDI2057/ODMEDI2058/ODMEDI2059/ODMEDI2060

**\* NOTICE**

- The average vehicle speed is not displayed if the driving distance is less than 50 meters (0.03 miles) or the driving time is less than 10 seconds since the ignition switch or Engine Start/Stop button is turned ON.
- Even if the vehicle is not in motion, the average vehicle speed keeps going while the engine is running.

**Elapsed Time (3)**

- The elapsed time is the total driving time since the last elapsed time reset.
  - Time range (hh:mm): 00:00 ~ 99:59
- To reset the elapsed time, press the SELECT/RESET button  on the steering wheel for more than 1 second when the elapsed time is displayed.

**\* NOTICE**

Even if the vehicle is not in motion, the elapsed time keeps going while the engine is running.

**Fuel Economy**



**Distance To Empty (1)**

- The distance to empty is the estimated distance the vehicle can be driven with the remaining fuel.
  - Distance range: 50 ~ 9999 km or 30 ~ 9999 mi.
- If the estimated distance is below 50 km (30 mi.), the trip computer will display “---” as distance to empty.

**\* NOTICE**

- If the vehicle is not on level ground or the battery power has been interrupted, the distance to empty function may not operate correctly.
- The distance to empty may differ from the actual driving distance as it is an estimate of the available driving distance.
- The trip computer may not register additional fuel if less than 6 liters (1.6 gallons) of fuel are added to the vehicle.
- The fuel economy and distance to empty may vary significantly based on driving conditions, driving habits, and condition of the vehicle.

### **Average Fuel Economy (2)**

- The average fuel economy is calculated by the total driving distance and fuel consumption since the last average fuel economy reset.
  - Fuel economy range: 0.0 ~ 99.9 L/100km or MPG
- The average fuel economy can be reset both manually and automatically.

#### **Manual reset**

To clear the average fuel economy manually, press the SELECT/RESET button  on the steering wheel for more than 1 second when the average fuel economy is displayed.

#### **Automatic reset**

To make the average fuel economy be reset automatically whenever refueling, select the “Auto Reset” mode in User Setting menu of the LCD display (Refer to “LCD Display”).

Under “Auto Reset” mode, the average fuel economy will be cleared to zero (---) when the vehicle speed exceeds 1 km/h after refueling more than 6 liters (1.6 gallons).

#### **\* NOTICE**

**The average fuel economy is not displayed for more accurate calculation if the vehicle does not drive more than 10 seconds or 50 meters (0.03 miles) since the ignition switch or Engine Start/Stop button is turned to ON.**

### **Instant Fuel Economy (3)**

- This mode displays the instant fuel economy during the last few seconds when the vehicle speed is more than 10 km/h (6.2 MPH).
  - Fuel economy range: 0 ~ 30 L/100km or 0 ~ 50 MPG

## WARNING AND INDICATOR LIGHTS

### Warning lights

#### \* NOTICE - Warning lights

Make sure that all warning lights are OFF after starting the engine. If any light is still ON, this indicates a situation that needs attention.

#### *Air bag Warning Light*



**This warning light illuminates:**

- Once you set the ignition switch or Engine Start/Stop Button to the ON position.
  - It illuminates for approximately 6 seconds and then goes off.
- When there is a malfunction with the SRS.

In this case, we recommend that you have the vehicle inspected by an authorized HYUNDAI dealer.

تلفن سینه روزی: ۰۲۱-۸۸۸۸۸۸۸۸

FarmaSOS.com

#### *Seat Belt Warning Light*



This warning light informs the driver that the seat belt is not fastened.

For more details, refer to the “Seat Belts” in chapter 3.



### ***Parking Brake & Brake Fluid Warning Light***



#### **This warning light illuminates:**

- Once you set the ignition switch or Engine Start/Stop Button to the ON position.
  - It illuminates for approximately 3 seconds
  - It remains on if the parking brake is applied.
- When the parking brake is applied.
- When the brake fluid level in the reservoir is low.
  - If the warning light illuminates with the parking brake released, it indicates the brake fluid level in reservoir is low.

#### **If the brake fluid level in the reservoir is low:**

1. Drive carefully to the nearest safe location and stop your vehicle.
2. With the engine stopped, check the brake fluid level immediately and add fluid as required (For more details, refer to “Brake Fluid” in chapter 7). Then check all brake components for fluid leaks. If any leak on brake system is still found, the warning light remains on, or the brakes do not operate properly, do not drive the vehicle.

In this case, we recommend that you have the vehicle towed to an authorized HYUNDAI dealer and inspected.

[FarmaSOS.com](http://FarmaSOS.com)

#### **Dual-diagonal braking system**

Your vehicle is equipped with dual-diagonal braking systems. This means you still have braking on two wheels even if one of the dual systems should fail.

With only one of the dual systems working, more than normal pedal travel and greater pedal pressure are required to stop the vehicle.

Also, the vehicle will not stop in as short a distance with only a portion of the brake system working.

If the brakes fail while you are driving, shift to a lower gear for additional engine braking and stop the vehicle as soon as it is safe to do so.

**⚠ WARNING - Parking Brake & Brake Fluid Warning Light**

Driving the vehicle with a warning light ON is dangerous. If the Parking Brake & Brake Fluid Warning Light illuminates with the parking brake released, it indicates that the brake fluid level is low.

In this case, we recommend that you have the vehicle inspected by an authorized HYUNDAI dealer.

**Anti-lock Brake System (ABS) Warning Light**



**This warning light illuminates:**

- Once you set the ignition switch or Engine Start/Stop Button to the ON position.
  - It illuminates for approximately 3 seconds and then goes off.
- When there is a malfunction with the ABS (The normal braking system will still be operational without the assistance of the anti-lock brake system).

In this case, we recommend that you have the vehicle inspected by an authorized HYUNDAI dealer.

FarmaSOS.com

**Electronic Brake force Distribution (EBD) System Warning Light**



**These two warning lights illuminate at the same time while driving:**

- When the ABS and regular brake system may not work normally. In this case, we recommend that you have the vehicle inspected by an authorized HYUNDAI dealer.

**⚠ WARNING - Electronic Brake force Distribution (EBD) System Warning Light**

When both ABS and Parking Brake & Brake Fluid Warning Lights are on, the brake system will not work normally and you may experience an unexpected and dangerous situation during sudden braking.

In this case, avoid high speed driving and abrupt braking.

We recommend you have the vehicle inspected by an authorized HYUNDAI dealer as soon as possible.

**\* NOTICE - Electronic Brake force Distribution (EBD) System Warning Light**

When the ABS Warning Light is on or both ABS and Parking Brake & Brake Fluid Warning Lights are on, the speedometer, odometer, or trip-meter may not work. Also, the EPS Warning Light may illuminate and the steering effort may increase or decrease.

In this case, we recommend you have the vehicle inspected by an authorized HYUNDAI dealer as soon as possible.

**Electric Parking Brake (EPB) Warning Light (if equipped)**



**This warning light illuminates:**

- Once you set the ignition switch or Engine Start/Stop Button to the ON position.
  - It illuminates for approximately 3 seconds and then goes off.
- When there is a malfunction with the EPB.

In this case, we recommend that you have the vehicle inspected by an authorized HYUNDAI dealer.

**Electronic Power Steering (EPS) Warning Light (if equipped)**



**This warning light illuminates:**

- Once you set the ignition switch or Engine Start/Stop Button to the ON position.
  - It remains on until the engine is started.
- When there is a malfunction with the EPS.

In this case, we recommend that you have the vehicle inspected by an authorized HYUNDAI dealer.

**\* NOTICE - Electric Parking Brake (EPB) Warning Light**

The Electric Parking Brake (EPB) Warning Light may illuminate when the Electronic Stability control (ESC) Indicator Light comes on to indicate that the ESC is not working properly (This does not indicate malfunction of the EPB).

**Malfunction Indicator Lamp (MIL)**



This warning light illuminates:

- Once you set the ignition switch or Engine Start/Stop Button to the ON position.
  - It remains on until the engine is started.
- When there is a malfunction with the emission control system.

In this case, we recommend that you have the vehicle inspected by an authorized HYUNDAI dealer.

**CAUTION - Malfunction Indicator Lamp (MIL)**

*Driving with the Malfunction Indicator Lamp (MIL) on may cause damage to the emission control systems which could effect drivability and/or fuel economy.*

**CAUTION - Gasoline Engine**

*If the Malfunction Indicator Lamp (MIL) illuminates, potential catalytic converter damage is possible which could result in loss of engine power.*

*In this case, we recommend that you have the vehicle inspected by an authorized HYUNDAI dealer as soon as possible.*

تلفن شبانه روزی: ۰۲۱-۸۸۸۶۲۰۸۵

FarmaSOS.com

**CAUTION - Diesel Engine with DPF (if equipped)**

*When the Malfunction Indicator Lamp (MIL) blinks, it may stop blinking after driving the vehicle:*

- at more than 60km/h (37 mph), or
- at more than 2nd gear with 1500 ~ 2000 engine rpm for a certain time (for about 25 minutes).

*If the Malfunction Indicator Lamp (MIL) continues to blink in spite of the procedure, we recommend that you have the DPF system checked by an authorized HYUNDAI dealer.*

*If you continue to drive with the Malfunction Indicator Lamp (MIL) blinking for a long time, the DPF system can be damaged and fuel consumption can worsen.*

**⚠ CAUTION - Diesel Engine**  
*If the Malfunction Indicator Lamp (MIL) blinks, some error related to the injection quantity adjustment occurs which could result in loss of engine power, combustion noise and poor emission.*  
*In this case, we recommend that you have the engine control system inspected by an authorized HYUNDAI dealer.*

### Charging System Warning Light



**This warning light illuminates:**

- Once you set the ignition switch or Engine Start/Stop Button to the ON position.
  - It remains on until the engine is started.
- When there is a malfunction with either the alternator or electrical charging system.

**If there is a malfunction with either the alternator or electrical charging system:**

1. Drive carefully to the nearest safe location and stop your vehicle.
2. Turn the engine off and check the alternator drive belt for looseness or breakage.

If the belt is adjusted properly, there may be a problem in the electrical charging system.

In this case, we recommend that you have the vehicle inspected by an authorized HYUNDAI dealer as soon as possible.

### Engine Coolant Temperature Warning Light (if equipped)



**This warning light illuminates:**

- When the engine coolant temperature is above 120°C (248°F). This means that the engine is overheated and may be damaged.  
If your vehicle is overheated, refer to “Overheating” in chapter 6.

**⚠ CAUTION - Engine  
Overheating**

*Do not continue driving with the engine overheated. Otherwise engine may be damaged.*

### Engine Oil Pressure Warning Light



This warning light illuminates:

- Once you set the ignition switch or Engine Start/Stop Button to the ON position.
  - It remains on until the engine is started.
- When the engine oil pressure is low.

If the engine oil pressure is low:

1. Drive carefully to the nearest safe location and stop your vehicle.
2. Turn the engine off and check the engine oil level (For more details, refer to “Engine Oil” in section 7). If the level is low, add oil as required.

If the warning light remains on after adding oil or if oil is not available, we recommend that you have the vehicle inspected by an authorized HYUNDAI dealer as soon as possible.



### CAUTION - Engine Oil Pressure Warning Light

- ***If the engine does not stop immediately after the Engine Oil Pressure Warning Light is illuminated, severe damage could result.***
- ***If the warning light stays on while the engine is running, it indicates that there may be serious engine damage or malfunction. In this case,***
  1. ***Stop the vehicle as soon as it is safe to do so.*** تلفن شبانه روز
  2. ***Turn off the engine and check the oil level. If the oil level is low, fill the engine oil to the proper level.***
  3. ***Start the engine again. If the warning light stays on after the engine is started, turn the engine off immediately. In this case, we recommend that you have the vehicle inspected by an authorized HYUNDAI dealer.***

### Engine Oil Level Warning Light (if equipped)



This warning light illuminates:

- Once you set the ignition switch or Engine Start/Stop Button to the ON position
  - It remains on until the engine is started.
- When the engine oil level should be checked.

If the engine oil level is low:

1. Drive carefully to the nearest safe location and stop your vehicle.
2. Turn the engine off and check the engine oil level (For more details, refer to “Engine Oil” in chapter 7). If the level is low, add oil as required.

If the warning light remains on after adding oil or if oil is not available, we recommend that you have the vehicle inspected by an authorized HYUNDAI dealer as soon as possible.

### Low Fuel Level Warning Light



**This warning light illuminates:**  
When the fuel tank is nearly empty.

**If the fuel tank is nearly empty:**  
Add fuel as soon as possible.

 **CAUTION - Low Fuel Level**

*Driving with the Low Fuel Level warning light on or with the fuel level below “0 or E” can cause the engine to misfire and damage the catalytic converter (if equipped).*

### Low Tire Pressure Warning Light (if equipped)



**This warning light illuminates:**

- Once you set the ignition switch or Engine Start/Stop Button to the ON position.
  - It illuminates for approximately 3 seconds and then goes off.
- When one or more of your tires are significantly underinflated (The location of the underinflated tires are displayed on the LCD display).  
For more details, refer to “Tire Pressure Monitoring System (TPMS)” in chapter 6.

FarmaSOS.com

**This warning light remains on after blinking for approximately 60 seconds or repeats blinking and off at the intervals of approximately 3 seconds:**

- When there is a malfunction with the TPMS.

In this case, we recommend that you have the vehicle inspected by an authorized HYUNDAI dealer as soon as possible.

For more details, refer to “Tire Pressure Monitoring System (TPMS)” in chapter 6.

 **WARNING - Safe Stopping**

- **The TPMS cannot alert you to severe and sudden tire damage caused by external factors.**
- **If you notice any vehicle instability, immediately take your foot off the accelerator pedal, apply the brakes gradually with light force, and slowly move to a safe position off the road.**

**Door Ajar Warning Light**



**This warning light illuminates:**  
When a door is not close securely.

**Tailgate Open Warning Light**



**This warning light illuminates:**  
When the tailgate is not close securely.

**Fuel Filter Warning Light (Diesel Engine)**



**This warning light illuminates:**

- Once you set the ignition switch or Engine Start/Stop Button to the ON position.
  - It illuminates for approximately 3 seconds and then goes off.
- When water has accumulated inside the fuel filter.
  - In this case, remove the water from the fuel filter.

For more details, refer to “Fuel Filter” in chapter 7. تلفن شبانه روزی: ۰۲۱-۸۸۸۸۸۸۸۸

**⚠ CAUTION - Fuel Filter Warning Light**

- *When the Fuel Filter Warning Light illuminates, engine power (vehicle speed & idle speed) may decrease.*
- *If you keep driving with the warning light on, engine parts (injector, common rail, high pressure fuel pump) may be damaged. If this occurs, we recommend that you have the vehicle inspected by an authorized HYUNDAI dealer as soon as possible.*



### **4 Wheel Drive (4WD) Warning Light (if equipped)**

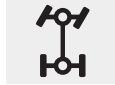

#### **This warning light illuminates:**

- Once you set the ignition switch or Engine Start/Stop Button to the ON position.
  - It illuminates for approximately 3 seconds and then goes off.
- When there is a malfunction with the 4WD system.

In this case, we recommend that you have the vehicle inspected by an authorized HYUNDAI dealer.

### **Overspeed Warning Light (if equipped)**

**120  
km/h**

#### **This warning light blinks:**

- When you drive the vehicle more than 120 km/h.
  - This is to prevent you from driving your vehicle with overspeed.
  - The overspeed warning chime also sound for approximately 5 seconds.

تلفن شبانه روزی: ۰۲۱-۸۸۸۶۲۰۸۵

**FarmaSOS.com**

### **Adaptive Front Lighting System (AFLS) Warning Light (if equipped)**

**AFLS**

#### **This warning light blinks:**

- When there is a malfunction with the AFLS.

#### **If there is a malfunction with the AFLS:**

1. Drive carefully to the nearest safe location and stop your vehicle.
2. Turn the engine off and restart the engine. If the warning light remains on, we recommend that you have the vehicle inspected by an authorized HYUNDAI dealer.

## Indicator Lights

### *Electronic Stability Control (ESC) Indicator Light (if equipped)*



#### **This indicator light illuminates:**

- Once you set the ignition switch or Engine Start/Stop Button to the ON position.
  - It illuminates for approximately 3 seconds and then goes off.
- When there is a malfunction with the ESC system.

In this case, we recommend that you have the vehicle inspected by an authorized HYUNDAI dealer.

#### **This indicator light blinks:**

While the ESC is operating.

For more details, refer to “Electronic Stability Control (ESC)” in chapter 5.

### *Electronic Stability Control (ESC) OFF Indicator Light (if equipped)*



#### **This indicator light illuminates:**

- Once you set the ignition switch or Engine Start/Stop Button to the ON position.
  - It illuminates for approximately 3 seconds and then goes off.
- When you deactivate the ESC system by pressing the ESC OFF button.

For more details, refer to “Electronic Stability Control (ESC)” in chapter 5.

[FarmaSOS.com](http://FarmaSOS.com)

### *ECO Indicator Light (if equipped)*

**ECO**

#### **This indicator light illuminates:**

When you activate the active ECO system by pressing the ACTIVE ECO button.

For more details, refer to “Active ECO System” in chapter 5.

### **Immobilizer Indicator Light (Without Smart Key) (if equipped)**



#### **This indicator light illuminates:**

- When the vehicle detects the immobilizer in your key properly while the ignition switch is ON.
  - At this time, you can start the engine.
  - The indicator light goes off after starting the engine.

#### **This indicator light blinks:**

- When there is a malfunction with the immobilizer system.

In this case, we recommend that you have the vehicle inspected by an authorized HYUNDAI dealer.

### **Immobilizer Indicator Light (With Smart Key) (if equipped)**



#### **This indicator light illuminates for up to 30 seconds:**

- When the vehicle detects the smart key in the vehicle properly while the Engine Start/Stop Button is ACC or ON.
  - At this time, you can start the engine.
  - The indicator light goes off after starting the engine.

#### **This indicator light blinks for a few seconds:**

- When the smart key is not in the vehicle.
  - At this time, you can not start the engine.

#### **This indicator light illuminates for 2 seconds and goes off:**

- When the vehicle can not detect the smart key which is in the vehicle while the Engine Start/Stop Button is ON.

In this case, we recommend that you have the vehicle inspected by an authorized HYUNDAI dealer.

#### **This indicator light blinks:**

- When the battery of the smart key is weak.
  - At this time, you can not start the engine. However, you can start the engine if you press the Engine Start/Stop Button with the smart key. (For more details, refer to “Starting the Engine” in section 5).
- When there is a malfunction with the immobilizer system.

In this case, we recommend that you have the vehicle inspected by an authorized HYUNDAI dealer.

**Turn Signal Indicator Light**

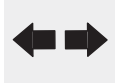

**This indicator light blinks:**

- When you turn the turn signal light on.

If any of the following occurs, there may a malfunction with the turn signal system. In this case, we recommend that you have the vehicle inspected by an authorized HYUNDAI dealer.

- The indicator light does not blink but illuminates.
- The indicator light blinks more rapidly.
- The indicator light does not illuminate at all.

**Low Beam Indicator Light (if equipped)**



**This indicator light illuminates:**

- When the headlights are on.

**High Beam Indicator Light**



**This indicator light illuminates:**

- When the headlights are on and in the high beam position
- When the turn signal lever is pulled into the Flash-to-Pass position. تلفن

**Light ON Indicator Light**



**This indicator light illuminates:**

- When the tail lights or headlights are on.

**Front Fog Indicator Light (if equipped)**



**This indicator light illuminates:**

- When the front fog lights are on.

**Rear Fog Indicator Light (if equipped)**



**This indicator light illuminates:**

- When the rear fog lights are on.

### **AUTO HOLD Indicator Light (if equipped)**

**AUTO HOLD**

#### **This indicator light illuminates:**

- [White] When you activate the auto hold system by pressing the AUTO HOLD button.
- [Green] When you stop the vehicle completely by depressing the brake pedal with the auto hold system activated.
- [Yellow] When there is a malfunction with the auto hold system.  
In this case, we recommend that you have the vehicle inspected by an authorized HYUNDAI dealer.

For more details, refer to “Auto Hold” in chapter 5.

### **Glow Indicator Light (Diesel Engine)**



#### **This indicator light illuminates:**

- When the engine is being preheated with the ignition switch or Engine Start/Stop Button in the ON position.
  - The engine can be started after the glow indicator light goes off.
  - The illumination time varies with the engine coolant temperature, air temperature, and battery condition.

If the indicator light remains on or blinks after the engine has warmed up or while driving, there may be a malfunction with the engine preheating system.

In this case, we recommend that you have the vehicle inspected by an authorized HYUNDAI dealer.

### **\* NOTICE - Engine Preheating**

If the engine does not start within 10 seconds after the preheating is completed, set the ignition switch or Engine Start/Stop Button to the **LOCK** or **OFF** position for 10 seconds and then to the **ON** position in order to preheat the engine again.

**4 Wheel Drive (4WD)  
LOCK Indicator Light  
(if equipped)**



**This indicator light illuminates:**

- Once you set the ignition switch or Engine Start/Stop Button to the ON position.
  - It illuminates for approximately 3 seconds and then goes off.
- When you select 4WD Lock mode by pressing the 4WD LOCK button.
  - The 4WD LOCK mode is to increase the drive power when driving on wet pavement, snow covered roads and/or off-road.

**⚠ CAUTION - 4WD Lock Mode**

***Do not use 4WD LOCK mode on dry paved roads or highway, it can cause noise, vibration or damage of 4WD related parts.***

**Cruise Indicator Light  
(if equipped)**



**CRUISE**

**This indicator light illuminates:**

- When the cruise control system is enabled.

For more details, refer to “Cruise Control System” in chapter 5.

**Cruise SET Indicator Light  
(if equipped)**

**SET**

**This indicator light illuminates:**

- When the cruise control speed is set.

For more details, refer to “Cruise Control System” in chapter 5.

**Downhill Brake Control  
(DBC) Indicator Light  
(if equipped)**



**This warning light illuminates:**

- Once you set the ignition switch or Engine Start/Stop Button to the ON position.
  - It illuminates for approximately 3 seconds and then goes off.
- When you activate the DBC system by pressing the DBC button.

**This warning light blinks:**

- When the DBC is operating.

**This warning light illuminates yellow:**

- When there is a malfunction with the DBC system.

In this case, we recommend that you have the vehicle inspected by an authorized HYUNDAI dealer.

For more details, refer to “Downhill Brake Control (DBC) System” in chapter 5.

## REAR PARKING ASSIST SYSTEM (IF EQUIPPED)

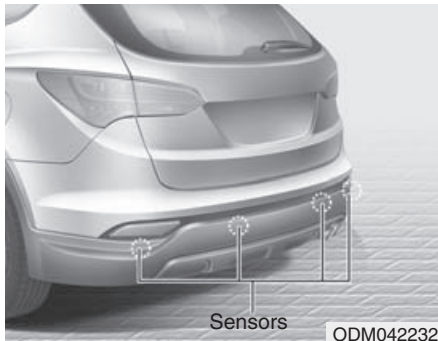

The rear parking assist system assists the driver during backward movement of the vehicle by chiming if any object is sensed within a distance of 120 cm (47 in.) behind the vehicle. This system is a supplemental system and it is not intended to nor does it replace the need for extreme care and attention of the driver. The sensing range and objects detectable by the back sensors are limited. Whenever backing-up, pay as much attention to what is behind you as you would in a vehicle without a rear parking assist system.

**⚠ WARNING**

The rear parking assist system is a supplementary function only. The operation of the rear parking assist system can be affected by several factors (including environmental conditions). It is the responsibility of the driver to always check the area behind the vehicle before and while backing up.

تلفن شبانه روزی: ۰۲۱-۸۸۸۶۲۰۸۵

FarmaSOS.com

## Operation of the rear parking assist system

### Operating condition

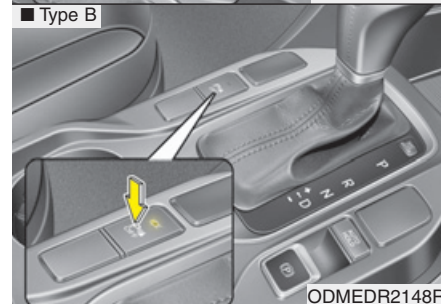
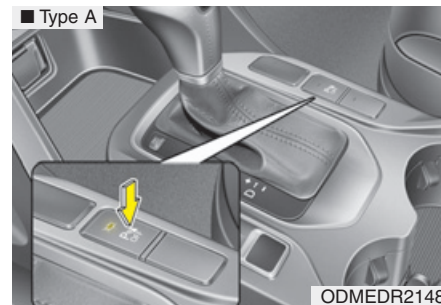

- This system will activate when the indicator on the rear parking assist OFF button is not illuminated.

If you desire to deactivate the rear parking assist system, press the rear parking assist OFF button again. (The indicator on the button will illuminate.) (if equipped)

- This system will activate when backing up with the ignition switch ON. If the vehicle is moving at a speed over 10 km/h (6 mph), the system may not be activated correctly.
- The sensing distance while the rear parking assist system is in operation is approximately 120 cm (47 in.).
- When more than two objects are sensed at the same time, the closest one will be recognized first.

#### **Types of warning sound**

- When an object is 120 cm to 61 cm (47 in. to 24 in.) from the rear bumper: Buzzer beeps intermittently.
- When an object is 60 cm to 31 cm (23 in. to 12 in.) from the rear bumper: Buzzer beeps more frequently.
- When an object is within 30 cm (11 in.) of the rear bumper: Buzzer sounds continuously.

#### **Non-operational conditions of rear parking assist system**

##### **The rear parking assist system may not operate properly when:**

1. Moisture is frozen to the sensor. (It will operate normally when the moisture has been cleared.)
2. The sensor is covered with foreign matter, such as snow or water, or the sensor cover is blocked. (It will operate normally when the material is removed or the sensor is no longer blocked.)
3. Driving on uneven road surfaces (unpaved roads, gravel, bumps, gradient).
4. Objects generating excessive noise (vehicle horns, loud motorcycle engines, or truck air brakes) are within range of the sensor.
5. Heavy rain or water spray exists.
6. Wireless transmitters or mobile phones are within range of the sensor.
7. The sensor is covered with snow.
8. Trailer towing

##### **The detecting range may decrease when:**

1. The sensor is stained with foreign matter such as snow or water. (The sensing range will return to normal when removed.)
2. Outside air temperature is extremely hot or cold.

##### **The following objects may not be recognized by the sensor:**

1. Sharp or slim objects such as ropes, chains or small poles.
2. Objects which tend to absorb the sensor frequency such as clothes, spongy material or snow.
3. Undetectable objects smaller than 1 m (40 in.) in height and narrower than 14 cm (6 in.) in diameter.



### Rear parking assist system precautions

- The rear parking assist system may not sound sequentially depending on the speed and shapes of the objects detected.
- The rear parking assist system may malfunction if the vehicle bumper height or sensor installation has been modified or damaged. Any non-factory installed equipment or accessories may also interfere with the sensor performance.
- The sensor may not recognize objects less than 30 cm (11 in.) from the sensor, or it may sense an incorrect distance. Use caution.
- When the sensor is frozen or stained with snow, dirt, or water, the sensor may be inoperative until the stains are removed using a soft cloth.
- Do not push, scratch or strike the sensor. Sensor damage could occur.

### \* NOTICE

This system can only sense objects within the range and location of the sensors; It can not detect objects in other areas where sensors are not installed. Also, small or slim objects, such as poles or objects located between sensors may not be detected by the sensors. Always visually check behind the vehicle when backing up. Be sure to inform any drivers of the vehicle that may be unfamiliar with the system regarding the systems capabilities and limitations.

#### **WARNING** تلفن شماره روزی: ۸۵

Pay close attention when the vehicle is driven close to objects on the road, particularly pedestrians, and especially children. Be aware that some objects may not be detected by the sensors, due to the object's distance, size or material, all of which can limit the effectiveness of the sensor. Always perform a visual inspection to make sure the vehicle is clear of all obstructions before moving the vehicle in any direction.

### Self-diagnosis

If you don't hear an audible warning sound or if the buzzer sounds intermittently when shifting the gear to the R (Reverse) position, this may indicate a malfunction in the rear parking assist system. If this occurs, we recommend that the system be checked by an authorized HYUNDAI dealer.

#### **WARNING**

Your new vehicle warranty does not cover any accidents or damage to the vehicle or injuries to its occupants due to a rear parking assist system malfunction. Always drive safely and cautiously.

## PARKING ASSIST SYSTEM (IF EQUIPPED)

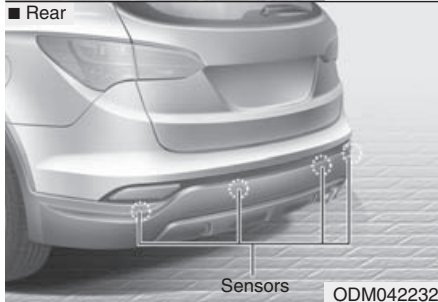
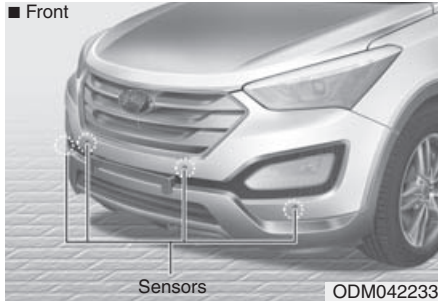

The parking assist system assists the driver during movement of the vehicle by chiming if any object is sensed within the distance of 60 cm (24 in.) (Type A) or 100 cm (39.4 in.) (Type B) in front and 120 cm (47 in.) behind the vehicle.

This system is a supplemental system and it is not intended to nor does it replace the need for extreme care and attention of the driver.

The sensing range and objects detectable by the sensors are limited. Whenever moving pay as much attention to what is in front and behind of you as you would in a vehicle without a parking assist system.

### **⚠ WARNING**

The parking assist system should only be considered as a supplementary function. The driver must check the front and rear view. The operational function of the parking assist system can be affected by many factors and conditions of the surroundings, so the responsibility rests always with the driver.

## Operation of the parking assist system

### Operating condition

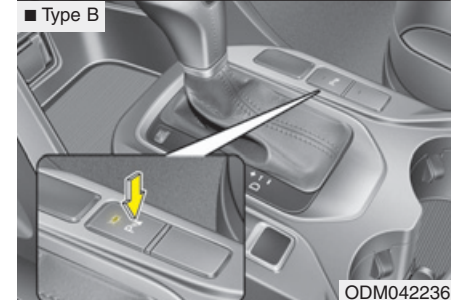
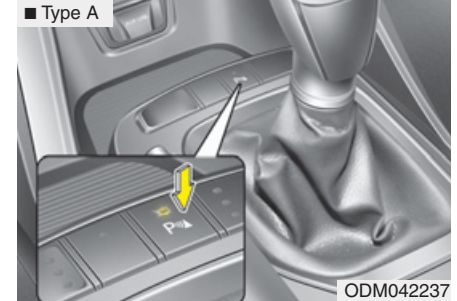

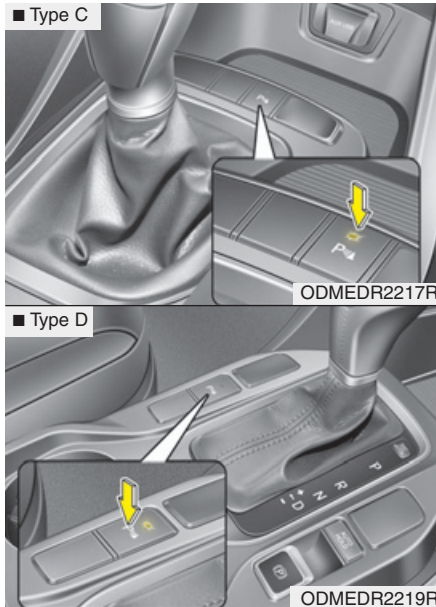

- This system activates when the parking assist system button is pressed with the ignition switch ON.

- The indicator of the parking assist system button turns on automatically and activates the parking assist system when you shift the gear to the R (Reverse) position or press the SPAS button. It will turn off automatically when you drive above 40 km/h (24.8 mph). (If equipped with SPAS)
- If the vehicle speed is above 10km/h (6.2 mph), the parking assist system will not operate.
- The sensing distance while backing up is approximately 120 cm (47 in.) when you are driving less than 10 km/h (6.2 mph).  
تلفن شبانه روزی: ۰۲۱-۸۸۸۸۸۸۸۸
- The side sensors are activated when you shift the gear to the R (Reverse) position.
- The sensing distance while moving forward is approximately 60 cm (24 in.) (Type A) or 100 cm (39.4 in.) (Type B) when you are driving less than 10 km/h (6.2 mph).
- When more than two objects are sensed at the same time, the closest one will be recognized first.

### \* NOTICE

**It may not operate if it's distance from the object is already less than approximately 25 cm when the system is ON.**

**Type of warning indicator and sound**

■ : with Warning sound  
 ■ : without Warning sound

Distance from object		Warning indicator				Warning sound
		When driving forward		When driving rearward		
		Type A	Type B	Type A	Type B	
100cm~61cm	Front			-	-	Buzzer beeps intermittently (Type B)
120cm~61cm	Rear	-	-			Buzzer beeps intermittently
60cm~31cm	Front					Buzzer beeps frequently
	Rear	-	-			Buzzer beeps frequently
30cm	Front					Buzzer sounds continuously
	Rear	-	-			Buzzer sounds continuously

**CAUTION**

- **This system can only sense objects within the range and location of the sensors; It can not detect objects in other areas where sensors are not installed. Also, small or slim objects, such as poles or objects located between sensors may not be detected by the sensors.**
- **Always visually check behind the vehicle when backing up.**
- **Be sure to inform any drivers of the vehicle that may be unfamiliar with the system regarding the systems capabilities and limitations.**

**\* NOTICE**

- The actual warning sound and indicator may differ from the illustration according to objects or sensor status.
- Do not wash the vehicle's sensor with high pressure water.

### **Non-operational conditions of parking assist system**

#### ***Parking assist system may not operate normally when:***

1. Moisture is frozen to the sensor. (It will operate normally when moisture melts.)
2. Sensor is covered with foreign matter, such as snow or water, or the sensor cover is blocked. (It will operate normally when the material is removed or the sensor is no longer blocked.)
3. Sensor is stained with foreign matter such as snow or water. (Sensing range will return to normal when removed.)
4. The parking assist button is off.

#### ***There is a possibility of parking assist system malfunction when:***

1. Driving on uneven road surfaces such as unpaved roads, gravel, bumps, or gradient.
2. Objects generating excessive noise such as vehicle horns, loud motorcycle engines, or truck air brakes can interfere with the sensor.
3. Heavy rain or water spray.
4. Wireless transmitters or mobile phones present near the sensor.
5. Sensor is covered with snow.

#### ***Detecting range may decrease when:***

1. Outside air temperature is extremely hot or cold.
2. Undetectable objects smaller than 1 m and narrower than 14 cm in diameter.

#### ***The following objects may not be recognized by the sensor:***

1. Sharp or slim objects such as ropes, chains or small poles.
2. Objects, which tend to absorb sensor frequency such as clothes, spongy material or snow.

**\* NOTICE**

1. The warning may not sound sequentially depending on the speed and shapes of the objects detected.
2. The parking assist system may malfunction if the vehicle bumper height or sensor installation has been modified. Any non-factory installed equipment or accessories may also interfere with the sensor performance.
3. Sensor may not recognize objects less than 30 cm from the sensor, or it may sense an incorrect distance. Use with caution.
4. When the sensor is frozen or stained with snow or water, the sensor may be inoperative until the stains are removed using a soft cloth.
5. Do not push, scratch or strike the sensor with any hard objects that could damage the surface of the sensor. Sensor damage could occur.

**\* NOTICE**

This system can only sense objects within the range and location of the sensors, it can not detect objects in other areas where sensors are not installed. Also, small or slim objects, or objects located between sensors may not be detected. Always visually check in front and behind the vehicle when driving. Be sure to inform any drivers in the vehicle that may be unfamiliar with the system regarding the systems capabilities and limitations.

**⚠ WARNING**

Pay close attention when the vehicle is driven close to objects on the road, particularly pedestrians, and especially children. Be aware that some objects may not be detected by the sensors, due to the objects distance, size or material, all of which can limit the effectiveness of the sensor. Always perform a visual inspection to make sure the vehicle is clear of all obstructions before moving the vehicle in any direction.

**Self-diagnosis**

When you shift the gear to the R (Reverse) position and if one or more of the below occurs you may have a malfunction in the rear parking assist system.

- You don't hear an audible warning sound or if the buzzer sounds intermittently.



(blinks)

-  is displayed. (if equipped)

If this occurs, we recommend that the system be checked by an authorized HYUNDAI dealer.

**⚠ WARNING**

Your new vehicle warranty does not cover any accidents or damage to the vehicle or injuries to its occupants related to a parking assist system. Always drive safely and cautiously.

## SMART PARKING ASSIST SYSTEM (SPAS) (IF EQUIPPED)

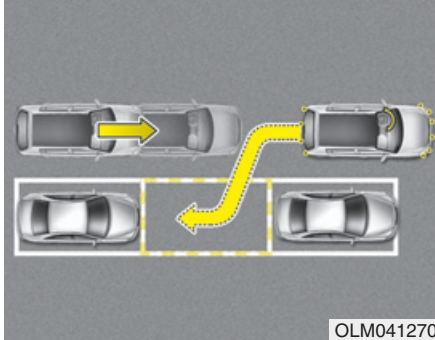

The Smart Parking Assist System helps drivers park their vehicle by using sensors to measure parallel parking spaces, control the steering wheel to semi-automatically park the car and provide instruction on the LCD display to help through parking.

### \* NOTICE

- The vehicle will not stop for pedestrians or objects that may be in its path, so the driver must monitor the maneuver.
- Use the system only in parking lots and places used for parking.
- The system does not work if there is no car parked in front of the parking space you are planning to park or if it is a diagonal parking space.
- After parking your vehicle using the system, the vehicle may not be parked at the exact spot you have wished. For example, the space between your vehicle and wall may not be the distance you have desired.
- Deactivate the system and park your vehicle manually, when the situation requires parking manually.
- The Parking Assist System's front and rear warning sound activates when the Smart Parking Assist System is activated.
- After searching for a parking space is completed, the Smart Parking Assist System will be canceled if the Parking Assist System is cancelled by pressing the button to the OFF position.

### ⚠ WARNING

- The Smart Parking Assist System should only be considered as a supplementary function. The driver must check the front and rear view for objects. The operational function of the Smart Parking Assist System can be affected by many factors and conditions of the surroundings, so the responsibility rests always with the driver.
- The system may not operate normally if the vehicle needs wheel alignment adjustment. We recommend that the system be checked by an authorized HYUNDAI dealer.
- If you use a different tire or wheel size rather than the size recommended by the HYUNDAI dealer, the system may not work properly. Always use the same size tire and wheel.

## Operating condition

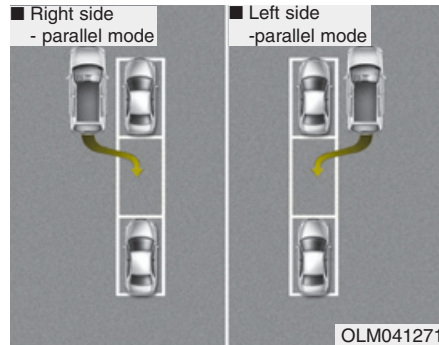

The system will help park the vehicle in the middle or back of a parked vehicle. Use the system when all the below conditions are met.

- When the parking space is a straight line
- When parallel parking is required
- When there is a parked vehicle
- When there is enough space to move the vehicle

## Non-operating condition

Never use the Smart Parking Assist System in the below conditions.

- Curved parking space
- Inclined roads
- A vehicle loaded with longer or wider cargo compared to the vehicle
- Diagonal parking space
- Parking space with trash, grass or barriers
- Heavy snow or rain
- A pole close to the parking line
- Bumpy roads
- A vehicle equipped with a snow chain or spare tire
- Tire pressure lower or higher than the standard tire pressure
- A trailer connected to the vehicle
- Slippery or uneven road
- Big vehicles such as buses or trucks parked
- Sensor covered with foreign matter, such as snow or water
- Moisture frozen on the sensor.
- A motorcycle or bicycle parked

- A trash can or obstacle near
- Heavy wind
- Wheel changed to an unauthorized size
- A problem with the wheel alignment
- Next to a garden or bush



**⚠ WARNING**

Do not use the Smart Parking Assist System in the following conditions for unexpected results may occur and cause a serious accident.

**1. Parking on inclines**



The driver must apply the accelerator and brake pedal when parking on inclines. If the driver is unfamiliar with applying the accelerator and brake pedal, a car accident may occur.

**(Continued)**

**(Continued)**

**2. Parking in snow**



Snow may interfere with sensor operation or the system may cancel if the road is slippery while parking. Also, if the driver is unfamiliar with applying the accelerator and brake pedal, a car accident may occur.

**(Continued)**

**(Continued)**

**3. Parking in narrow space**



The system may not search for parking spaces if the space is too narrow. Even if it operates always be careful.

**(Continued)**

(Continued)  
4. Parking diagonal

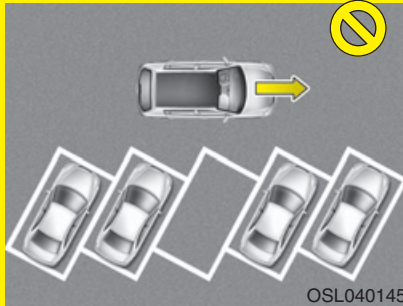

The system is a supplemental for parallel parking. Diagonal line parking is not available. Even if the vehicle is able to enter the space, do not operate the Smart Parking Assist System. The system will attempt parallel parking.

(Continued)

(Continued)  
5. Parking in uneven road



Parking in uneven roads, the driver needs to properly apply the pedal (clutch, accelerator or brake). If not, the system may cancel when the vehicle slips or an accident may occur.

(Continued)

(Continued)  
6. Parking behind a truck



An accident may occur when parking behind a vehicle higher than yours. For example, bus, truck, etc.

(Continued)

(Continued)

### 7. Obstacle in parking space

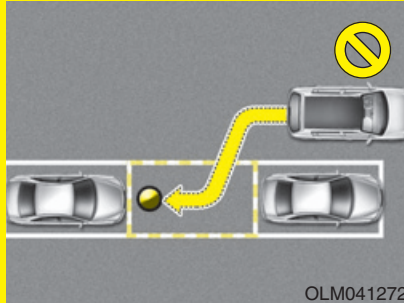

The system may search for a parking space even though an obstacle is in the parking space. An accident may occur if you continue to park the vehicle with the system.

**Do not solely rely on the Smart Parking Assist System.**

### How the system works

1. Activate the Smart Parking Assist System
2. Select parking assist mode
3. Search for parking space (slowly move forward.)
4. Search complete (automatic search by sensor.)
5. Steering wheel control
  - (1) Shift according to the instruction on the LCD display.
  - (2) Drive slowly with the brake pedal applied.
6. Smart Parking Assist System complete
7. If necessary, manually adjust position of vehicle.

### \* NOTICE

- Before activating the system check if the conditions are possible to use the system.
- For your safety, always apply the brake pedal except for when driving.

### 1. Activate Smart Parking Assist System

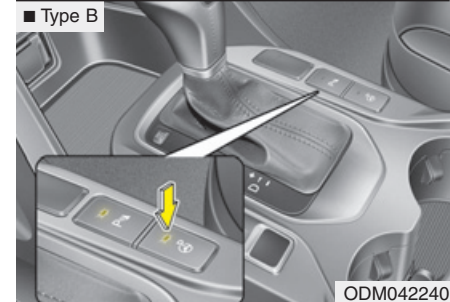
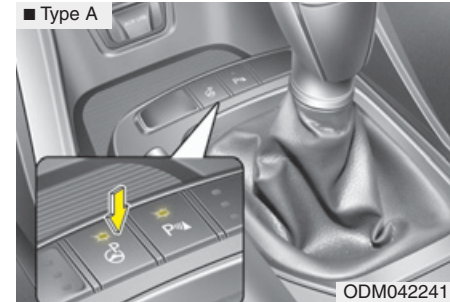

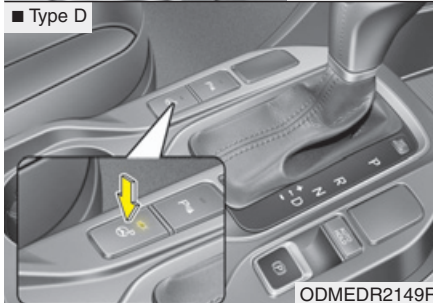
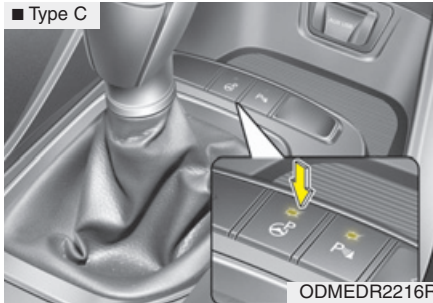

- Press the Smart Parking Assist System button again for more than 2 seconds to turn off the system.
- The Smart Parking Assist System defaults to the OFF position whenever the ignition switch is turned on.

امداد خودرو فارما

تلفن شبانه روزی: ۰۲۱-۸۸۸۶۲۰۸۵

FarmaSOS.com

## 2. Select parking assist mode



- Select the parking assist mode by pressing the Smart Parking Assist System button with the shift lever in N (Neutral) or D(Drive) and the brake pedal depressed.

- Press the Smart Parking Assist System button (the button indicator will illuminate).
- The Parking Assist System will be activated (the button indicator will illuminate).

A warning sound will be heard if an obstacle is detected.

- The right side parallel mode is selected automatically when the Smart Parking Assist System is activated.
- To select the left side parallel mode press the Smart Parking Assist System button once more.
- If the button is pressed again, the system will turn off.

### 3. Search for parking space



- Slowly drive forward maintaining the distance of approximately 50cm ~ 150cm (19.6in.~59.0in.) with the parked vehicles. The side sensors will search for a parking space.

- If the vehicle speed is over 30km/h (18.6mph), a message will appear to notify to reduce speed.
- If the vehicle speed is over 40km/h (24.8mph), the system will cancel.

### \* NOTICE

- Turn on the hazard warning flasher if it is crowded with other vehicles.
- If the parking lot is small, slowly drive more nearer to the parking space.
- The search for a parking space will be completed only when there is enough space for the vehicle to move to park.

**\* NOTICE**

- When searching for a parking space, the system may not be able to find a parking space if there is no vehicle parked, a parking space is available after driving by or a parking space is available before driving by.
- The system may not operate normally in the following conditions:
  - (1) When the sensors are frozen
  - (2) When the sensors are dirty
  - (3) When it snows or rains heavily
  - (4) When a pillar or object is near

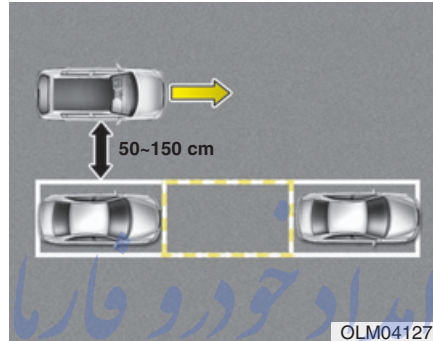

**\* NOTICE**

Slowly drive forward maintaining the distance of approximately 50cm ~ 150cm (19.6in.~59.0in.) with the parked vehicles. If not within the distance, the system may not be able to search for a parking space.

**⚠ CAUTION**

*After searching for a parking space is completed, continue using the system after checking the surrounding area.*

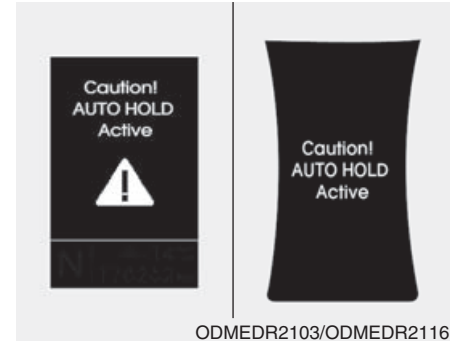

**⚠ CAUTION**

*While using the Smart Parking Assist System if the Auto Hold activates the above message will appear. Turn the Auto Hold operation off. When you cancel the Auto Hold operation by depressing the accelerator pedal, always check the surrounding area near your vehicle.*

### 4. Search complete

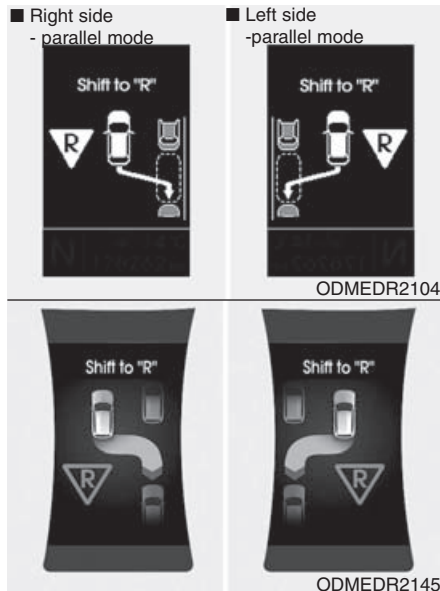

While driving forward to search for a parking space, the above message will appear with a beep sound if the search is complete. Stop the vehicle and shift to the R (Reverse) position.

### ⚠ CAUTION

- Always drive slowly with the brake pedal applied.
- If the parking space is too small the system may be cancelled at the Steering wheel control stage. Do not park your vehicle if the space is too small.

امداد خودرو فارما

تلفن شبانه روزی: ۰۲۱-۸۸۸۶۲۰۸۵

FarmaSOS.com

### 5. Steering wheel control

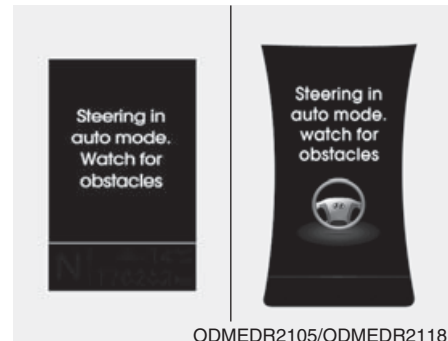

- The above message will appear if the shift lever is in R (Reverse). The steering wheel will be controlled automatically.
- The system will be cancelled if you firmly hold the steering wheel while it is controlled automatically.
- The system will be cancelled if vehicle speed is over 7km/h(4.3mph).

**⚠ WARNING**

Do not put your hands between the steering wheel while it is being automatically controlled.

**⚠ CAUTION**

- *Always drive slowly with the brake pedal applied.*
- *Always check for objects around your vehicle before driving.*
- *If the vehicle does not move even though the brake pedal is not depressed, check the surrounding before depressing the accelerator pedal. Be sure not to speed over 7km/h (4.3mph).*

**\* NOTICE**

- If you do not follow the instructions provided, you may fail to park your vehicle. However, if the Parking Assist System warning sound (distance from object is within 30cm: continuous beep) occurs, slowly drive the vehicle to the reverse direction of the detected object after checking the surrounding.
- Always check the surrounding before driving your vehicle if the Parking Assist System warning sound (distance from object is within 30cm: continuous beep) is heard for the object is close to your vehicle.

FarmaSOS.com

**To cancel the system while parking**

Press the Smart Parking Assist System button or turn the steering wheel to the left or right.



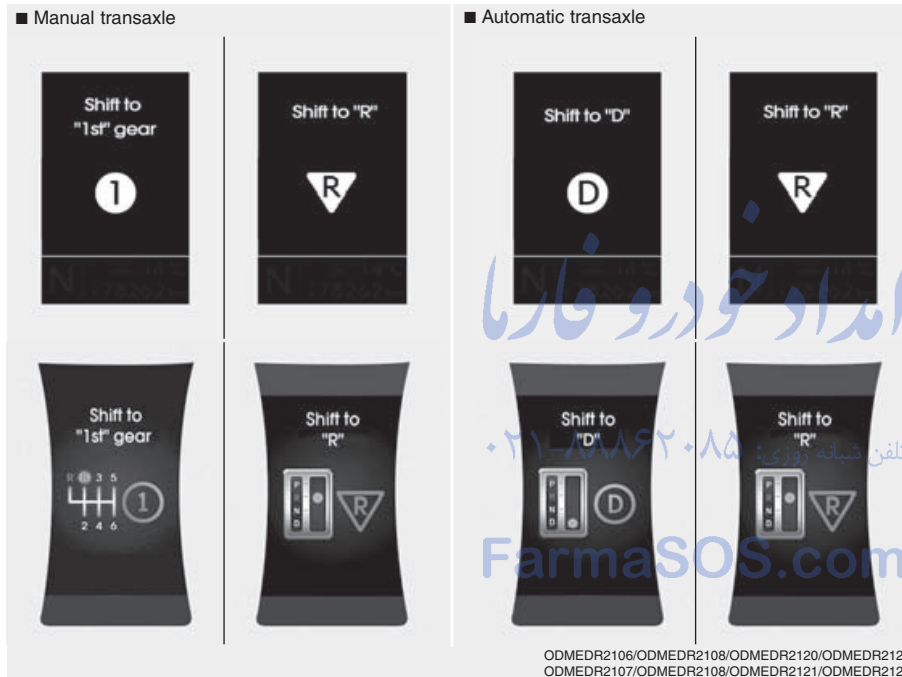

**CAUTION**  
Always check the surrounding before releasing the brake pedal.

**WARNING**  
Always be careful while parking for other vehicles or pedestrians.

### Gear shift while steering wheel control

When the above message appears with a beep sound, shift the gear and drive the vehicle with the brake pedal depressed.

## 6. Smart Parking Assist System completed

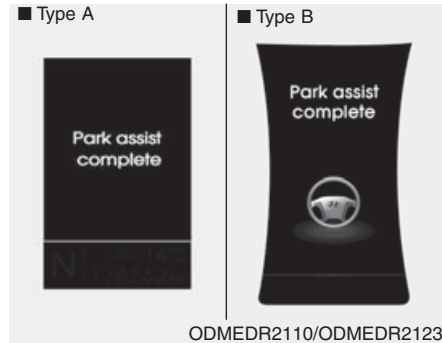

Complete parking your vehicle according to the instructions on the LCD display. If required, manually control the steering wheel and complete parking your vehicle.

### \* NOTICE

The brake pedal must be depressed by the driver while parking your vehicle.

The system may be cancelled in the below conditions:

- Ignoring the gear shift message and drive the vehicle approximately 150cm (59in).
- The front and rear Parking Assist System warning sound (distance from object is within 30cm: continuous beep) is heard at the same time.
- 6 minutes have passed since the vehicle has been controlled by the Smart Parking Assist System.
- The shift lever is changed to the P (Park) or R (Reverse) position while searching for parking space.

FarmaSOS.com

## Additional instructions (messages)



When the Smart Parking Assist System is operating, a message may appear regardless of the parking order.

The messages will appear according to the circumstances. Follow the instructions provided while parking your vehicle with the Smart Parking Assist System.

### \* NOTICE

In the below conditions the system will be cancelled. Park your vehicle manually.

#### 1. Search for parking space

- When the ABS/ESC is activated
- When the vehicle speed is over 40km/h (24.8mph)
- When you press the Smart Parking Assist System button (the front and rear Parking Assist System operates)
- When you shift the shift lever to R (Reverse)

#### 2. Steering wheel control

- When the ABS/ESC is activated
- When the vehicle speed is over 7km/h (4.3 mph)
- When you press the Smart Parking Assist System button (the front and rear Parking Assist System operates)
- When you shift the shift lever to D (Drive) before entering the parking space
- When you hold the steering wheel firmly

### System malfunction



- If there is a problem with the system, when the system is turned on, the above message will appear. Also, the indicator on the button will not light up and a beep sound will be heard 3 times.
- If there is a problem with only the Smart Parking Assist System, the Parking Assist System will operate after 2 seconds.

If you notice any problem, we recommend that the system be checked by an authorized HYUNDAI dealer.

## REARVIEW CAMERA (IF EQUIPPED)

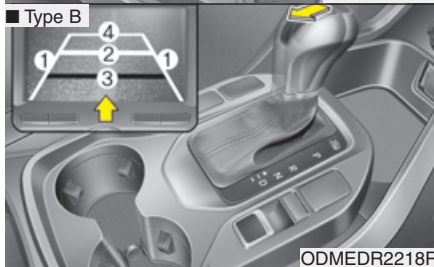
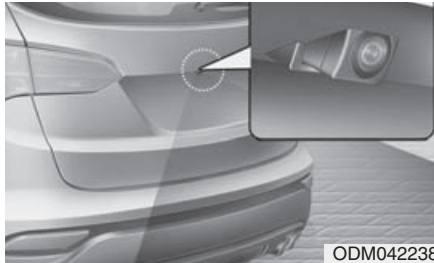

The rearview camera will activate when the back-up light is ON with the ignition switch ON and the shift lever in the R (Reverse) position.

1. Vehicle width
2. 100 cm from the rear bumper
3. 50 cm from the rear bumper
4. 300 cm from the rear bumper

### \* NOTICE

The warning "Warning ! Check surroundings for safety " will appear on the rearview display when the rearview camera is activated.

### ⚠ WARNING

- This system is a supplementary function only. It is the responsibility of the driver to always check the inside/outside rearview mirror and the area behind the vehicle before and while backing up because there is a dead zone that cannot be seen through the camera.
- Always keep the camera lens clean. If the lens is covered with foreign matter, the camera may not operate normally.

FarmaSOS.com

## HAZARD WARNING FLASHER



The hazard warning lights are turned on by pushing in the hazard switch. This causes all turn signal lights to blink. The hazard warning lights will operate even though the key is not in the ignition switch.

To turn the hazard warning lights off, push the switch a second time.

امداد خودرو فارما

تلفن شبانه روزی: ۰۲۱-۸۸۸۶۲۰۸۵

FarmaSOS.com

The hazard warning flasher should be used whenever you find it necessary to stop the car in a hazardous location. When you must make such an emergency stop, always pull off the road as far as possible.

## LIGHTING

### Battery saver function

- The purpose of this feature is to prevent the battery from being discharged. The system automatically turns off the parking lights when the driver removes the ignition key and opens the driver- side door.
- With this feature, the parking lights will be turned off automatically if the driver parks on the side of road at night.

If necessary, to keep the lights on when the ignition key is removed, perform the following :

- 1) Open the driver-side door.
- 2) Turn the parking lights OFF and ON again using the light switch on the steering column.

### CAUTION

***If the driver gets out of the vehicle through other doors (except driver's door), the battery saver function does not operate. Therefore, it causes the battery to be discharged. In this case, make sure to turn off the lamp before getting out of the vehicle.***

### Headlight (Headlamp) escort function (if equipped)

The headlights (and/or taillights) remain on for approximately 5 minutes after the ignition key is removed or turned to the ACC or LOCK position. However, if the driver's door is opened and closed, the headlights are turned off after 15 seconds.

The headlights can be turned off by pressing the lock button on the transmitter or smart key twice or turning off the light switch from the headlight or Auto light position.

تلفن شبانه روزی: ۰۲۱-۸۸۸۶۲۰۸۵

FarmaSOS.com

### Smart cornering light (if equipped)

While driving the corner, for your sight and safety, the smart cornering light turns on when all the below conditions are satisfied:

- Headlights are turned on.
- Vehicle speed is under 40km/h.
- The turn signal light is turned on to the direction that you try to turn.

## Lighting control

■ Type A

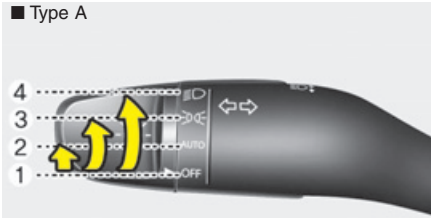

ODMECO2004

■ Type B



ODMECO2005

The light switch has a Headlight and a Parking light position.

To operate the lights, turn the knob at the end of the control lever to one of the following positions:

■ Type C

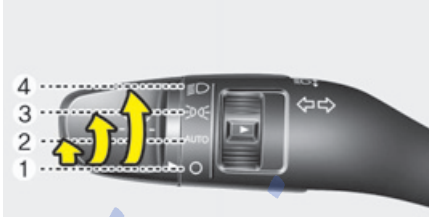

ODMECO2006

■ Type D



ODMECO2007

- (1) OFF position
- (2) Auto light position (if equipped)
- (3) Parking light position
- (4) Headlight position

## Parking light position ( ٤٠٤ )

■ Type A

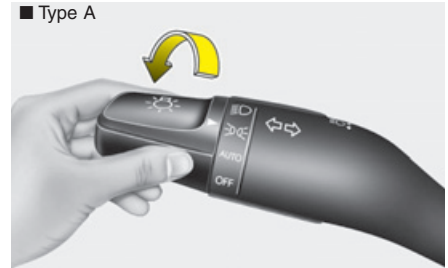

ODMECO2008

■ Type B



ODMECO2009

When the light switch is in the parking light position, the tail, position, license and instrument panel lights are ON.

### Headlight position (☺)

■ Type A



■ Type B



When the light switch is in the headlight position the head, tail, position, license and instrument panel lights are ON.

### \* NOTICE

The ignition switch must be in the ON position to turn on the headlights.

امداد خودرو فارما

تلفن شبانه روزی: ۰۲۱-۸۸۸۶۲۰۸۵

FarmaSOS.com

### Auto light/AFLS position (if equipped)

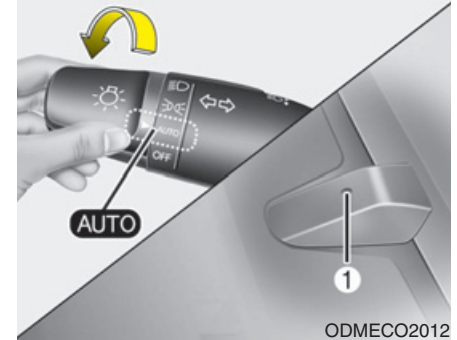

When the light switch is in the AUTO light position, the taillights and headlights will be turned ON or OFF automatically depending on the amount of light outside the vehicle.

If your vehicle is equipped with the adaptive front lighting system (AFLS), it will also operate when the headlamp is ON.



### ⚠ CAUTION

- **Never place anything over the sensor (1) located on the instrument panel, this will ensure better auto-light system control.**
- **Don't clean the sensor using a window cleaner, the cleaner may leave a light film which could interfere with sensor operation.**
- **If your vehicle has window tint or other types of coating on the front windshield, the Auto light system may not work properly.**

### Traffic change (for Europe)

Use this function when you visit a country with opposite traffic direction. If the traffic change is activated when you visit a country with opposite traffic direction, it will decrease the dazzle on oncoming vehicle drivers.

Follow the below procedure.

امداد خودرو فارما

تلفن شبانه روزی: ۰۲۱-۸۸۸۶۲۰۸۵

FarmaSOS.com

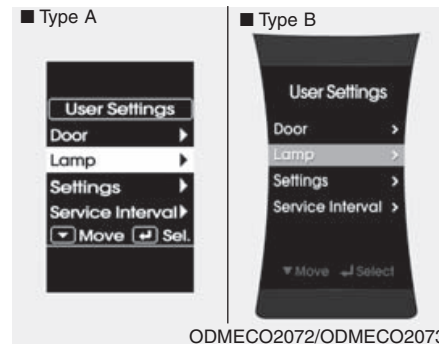

1. Select "User Settings" by pressing the mode button (⏏) on the steering wheel.
2. Select "Lamp" by pressing the move button (▼) and select button (↵) on the steering wheel.

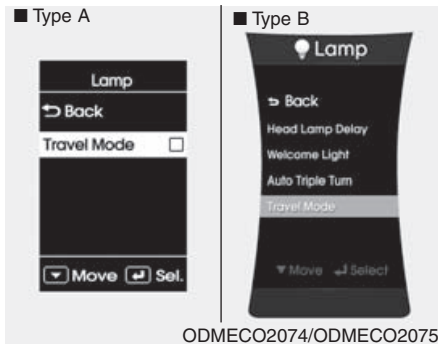

3. Check “Travel Mode” by pressing the move button (▼) and select button (↶) on the steering wheel.

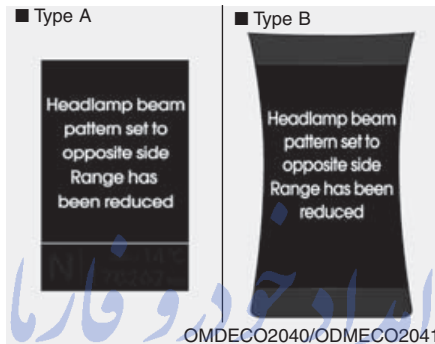

**\* NOTICE**

If the engine is turned off with the traffic change function activated, and the engine turned on again, the above message will appear. It is to notify the driver the function is activated.

4. To cancel the change, follow the steps 1 to 3 from the previous page.

**High - beam operation**

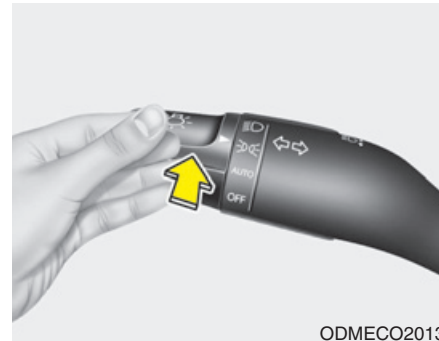

1. Turn the light switch to the headlight position.
2. Push the lever away from you.

### \* NOTICE

- The high-beam indicator will light when the headlight high beams are switched on.
- To prevent the battery from being discharged, do not leave the lights on for a prolonged time while the engine is not running.

### ⚠ WARNING

Do not use high beam when there are other vehicles. Using high beam could obstruct the other driver's vision.

### Flashing headlights

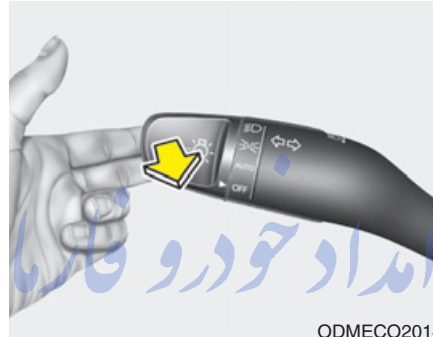

Pull the lever towards you. It will return to the normal position when released. The headlight switch does not need to be on to use this flashing feature.

FarmaSOS.com

### Turn signals and lane change signals

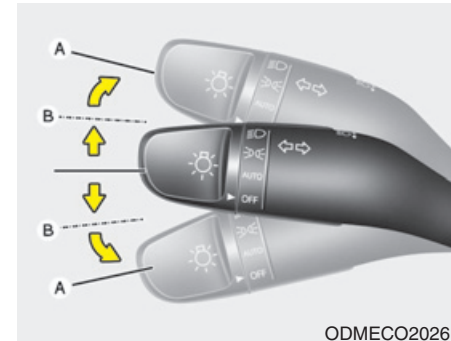

The ignition switch must be on for the turn signals to function. To turn on the turn signals, move the lever up or down (A). Green arrow indicators on the instrument panel indicate which turn signal is operating.

They will self-cancel after a turn is completed. If the indicator continues to flash after a turn, manually return the lever to the OFF position.

To signal a lane change, move the turn signal lever slightly and hold it in position (B). The lever will return to the OFF position when released.

If an indicator stays on and does not flash or if it flashes abnormally, one of the turn signal bulbs may be burned out and will require replacement.

### ***One-touch lane change function (if equipped)***

To activate an one-touch lane change function, move the turn signal lever slightly and then release it. The lane change signals will blink 3 times.

### **\* NOTICE**

**If an indicator flash is abnormally quick or slow, bulb may be burned out or have a poor electrical connection in the circuit.**

### **Front fog light (if equipped)**



Fog lights are used to provide improved visibility when visibility is poor due to fog, rain or snow, etc.

1. Turn on the park light.
2. Turn the light switch (1) to the front fog light position.
3. To turn off the front fog light, turn the light switch to the front fog light position again or turn off the park light.

### **⚠ CAUTION**

***When in operation, the fog lights consume large amounts of vehicle electrical power. Only use the fog lights when visibility is poor.***

### Rear fog light (if equipped)



To turn on the rear fog lights, do one of the following:

- Position the light switch in the headlight position and then turn the light switch (1) to the rear fog light position.
- Position the light switch in the park light, turn the light switch to the front fog light (if equipped) position, and then turn the light switch (1) to the rear fog light position.

To turn the rear fog lights off, do one of the following:

- Turn off the headlight switch.
- Turn the light switch to the rear fog light position again.
- When the light switch in the park light, if you turn off the front fog light, the rear fog light will also turn off.

امداد خودرو فارما

تلفن شبانه روزی: ۰۲۱-۸۸۸۶۲۰۸۵

FarmaSOS.com

### Daytime running light (if equipped)

Daytime Running Lights (DRL) can make it easier for others to see the front of your vehicle during the day. DRL can be helpful in many different driving conditions, and it is especially helpful after dawn and before sunset.

The DRL system will turn off the dedicated lamp when:

1. The front fog light or headlight (low beam) switch is ON.
2. The engine is OFF.

## Headlight leveling device (if equipped)

### Manual type

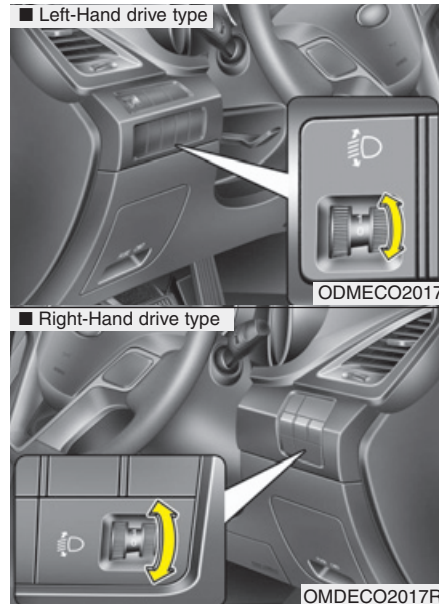

To adjust the headlight beam level according to the number of the passengers and the loading weight in the luggage area, turn the beam leveling switch.

The higher the number of the switch is positioned, the lower the headlight beam level. Always keep the headlight beam at the proper leveling position, or headlights may dazzle other road users.

Listed below are the examples of proper switch settings. For loading conditions other than those listed below, adjust the switch position so that the beam level may be the nearest as the condition obtained according to the list.

Loading condition	Switch position
Driver only	0
Driver + Front passenger	0
Full passengers (including driver)	1
Full passengers (including driver) + Maximum permissible loading	2
Driver + Maximum permissible loading	3

### Automatic type

It automatically adjusts the headlight beam level according to the number of passengers and loading weight in the luggage area.

And it offers proper headlight beam under various conditions.

### **⚠ WARNING**

**If it does not work properly even though your car is inclined backward according to passenger's posture, or the headlight beam is irradiated to the high or low position, we recommend that you have your vehicle inspected by an authorized HYUNDAI dealer.**

**Do not attempt to inspect or replace the wiring yourself.**

### Adaptive Front Lighting System (AFLS) (if equipped)

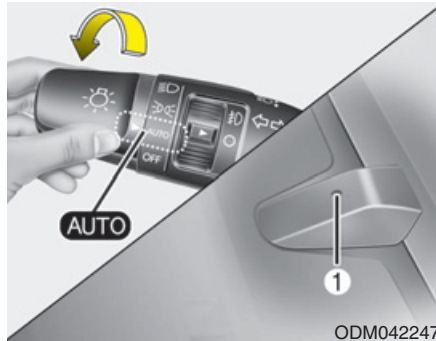

Adaptive front lighting system uses the steering angle and vehicle speed, to keep your field of vision wide by swiveling and leveling the headlamp.

Change the switch to the AUTO position when the engine is running. The adaptive front lighting system will operate when the headlamp is ON. To turn off the AFLS, change the switch to other positions. After turning the AFLS off, headlamp swiveling no longer occurs, but leveling operates continuously.



If the AFLS malfunction indicator comes on, the AFLS is not working properly. Drive to the nearest safe location and restart the engine. If the indicator continuously remains on, we recommend that you take your vehicle to an authorized HYUNDAI dealer and have the system checked.

## WIPERS AND WASHERS

### Windshield wiper/washer

■ Type A

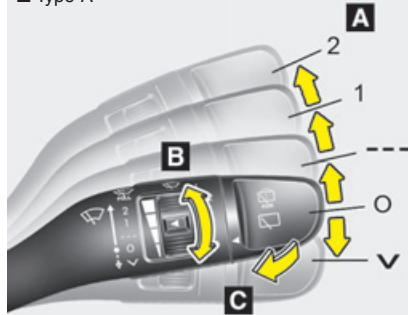

■ Type B

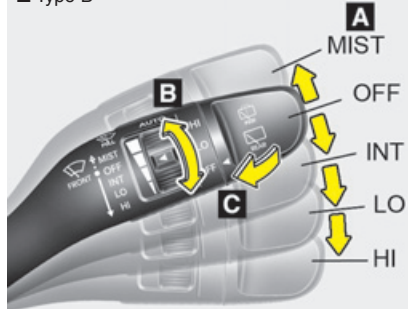

### Rear window wiper/washer

■ Type A

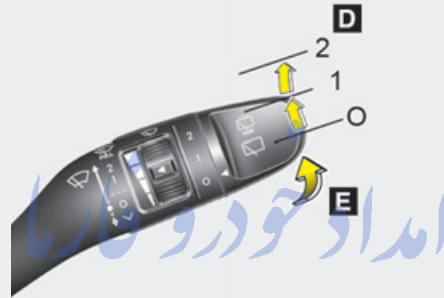

■ Type B

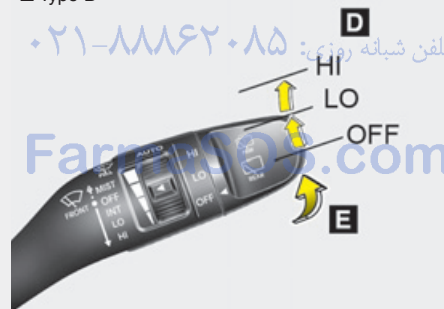

ODMECO2019/ODM042252/ODMECO2020/ODM042253

#### A : Wiper speed control (front)

- √ / MIST – Single wipe
- O / OFF – Off
- --- / INT – Intermittent wipe
- AUTO\* – Auto control wipe
- 1 / LO – Low wiper speed
- 2 / HI – High wiper speed

#### B : Intermittent control wipe time adjustment

#### C : Wash with brief wipes (front)\*

#### D : Rear wiper/washer control\*

- HI / 2 – High wiper speed
- LO / 1 – Low wiper speed
- OFF / O – Off

#### E : Wash with brief wipes (rear)

\* : if equipped



### Windshield wipers

Operates as follows when the ignition switch is turned ON.

✓/MIST : For a single wiping cycle, move the lever to this (✓/MIST) position and release it. The wipers will operate continuously if the lever is held in this position.

O/OFF : Wiper is not in operation

---/INT : Wiper operates intermittently at the same wiping intervals. Use this mode in light rain or mist. To vary the speed setting, turn the speed control knob.

1/LO : Normal wiper speed

2/HI : Fast wiper speed

### \* NOTICE

If there is heavy accumulation of snow or ice on the windshield, defrost the windshield for about 10 minutes, or until the snow and/or ice is removed before using the windshield wipers to ensure proper operation.

If you do not remove the snow and/or ice before using the wiper and washer, it may damage the wiper and washer system.

### Auto control (if equipped)

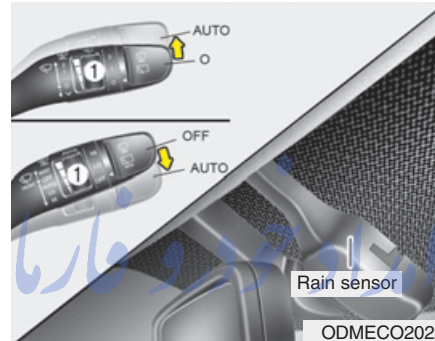

The rain sensor located on the upper end of the windshield glass senses the amount of rainfall and controls the wiping cycle for the proper interval. The more it rains, the faster the wiper operates.

When the rain stops, the wiper stops.

To vary the speed setting, turn the speed control knob (1).

If the wiper switch is set in AUTO mode when the ignition switch is ON, the wiper will operate once to perform a self-check of the system. Set the wiper to OFF position when the wiper is not in use.

### ⚠ CAUTION

When the ignition switch is ON and the windshield wiper switch is placed in the AUTO mode, use caution in the following situations to avoid any injury to the hands or other parts of the body:

- Do not touch the upper end of the windshield glass facing the rain sensor.
- Do not wipe the upper end of the windshield glass with a damp or wet cloth.
- Do not put pressure on the windshield glass.

**⚠ CAUTION**

*When washing the vehicle, set the wiper switch in the OFF position to stop the auto wiper operation.*

*The wiper may operate and be damaged if the switch is set in the AUTO mode while washing the vehicle.*

*Do not remove the sensor cover located on the upper end of the passenger side windshield glass. Damage to system parts could occur and may not be covered by your vehicle warranty.*

*When starting the vehicle in winter, set the wiper switch in the OFF position. Otherwise, wipers may operate and ice may damage the windshield wiper blades. Always remove all snow and ice and defrost the windshield properly prior to operating the windshield wipers.*

**Windshield washers  
(if equipped)**

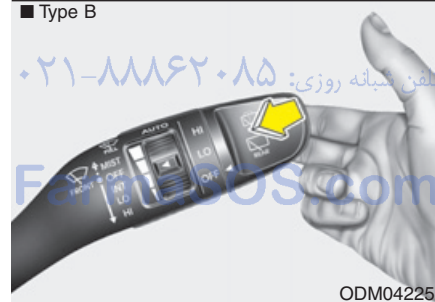
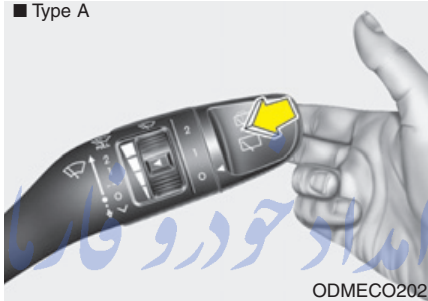

In the OFF position, pull the lever gently toward you to spray washer fluid on the windshield and to run the wipers 1-3 cycles.

Use this function when the windshield is dirty.

The spray and wiper operation will continue until you release the lever.

If the washer does not work, check the washer fluid level. If the fluid level is not sufficient, you will need to add appropriate non-abrasive windshield washer fluid to the washer reservoir.

The reservoir filler neck is located in the front of the engine compartment on the passenger side.

**⚠ CAUTION**

*To prevent possible damage to the washer pump, do not operate the washer when the fluid reservoir is empty.*

**⚠ WARNING**

Do not use the washer in freezing temperatures without first warming the windshield with the defrosters; the washer solution could freeze on the windshield and obscure your vision.

**⚠ CAUTION**

- *To prevent possible damage to the wipers or windshield, do not operate the wipers when the windshield is dry.*
- *To prevent damage to the wiper blades, do not use gasoline, kerosene, paint thinner, or other solvents on or near them.*
- *To prevent damage to the wiper arms and other components, do not attempt to move the wipers manually.*
- *To prevent possible damage to the wipers and washer system, use anti-freezing washer fluids in the winter season or cold weather.*

**Headlight washer (if equipped)**

If your vehicle is equipped with the headlight washer it will operate at the same time when you operate the windshield washer. It will operate when the headlight low beam is turned on and the ignition switch or engine start/stop button is in the ON position.

The washer fluid will be sprayed on to the headlights.

**\* NOTICE**

- Check the headlight washers periodically to confirm that the washer fluid is being sprayed properly onto the headlight lenses.
- The headlight washer can be operated 15 minutes after being operated last time.

## Rear window wiper and washer switch (if equipped)

■ Type A

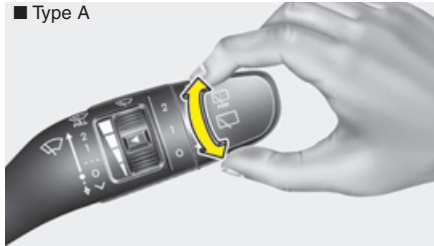

ODMECO2023

■ Type B

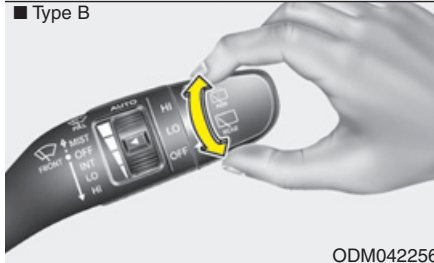

ODM042256

The rear window wiper and washer switch is located at the end of the wiper and washer switch lever. Turn the switch to the desired position to operate the rear wiper and washer.

HI / 2 – High wiper speed  
LO / 1– Low wiper speed  
OFF / O – Off

امداد خودرو فارما

تلفن شبانه روزی: ۰۲۱-۸۸۸۶۲۰۸۵

FarmaSOS.com

■ Type A

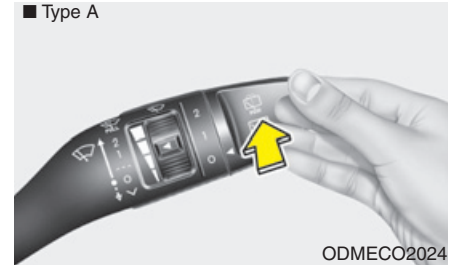

ODMECO2024

■ Type B



ODM042338

Push the lever away from you to spray rear washer fluid and to run the rear wipers 1~3 cycles. The spray and wiper operation will continue until you release the lever. (if equipped)

## INTERIOR LIGHT

### ⚠ CAUTION

*Do not use the interior lights for extended periods when the engine is not running. It may cause battery discharge.*

### ⚠ WARNING

Do not use the interior lights when driving in the dark. Accidents could happen because the view may be obscured by interior lights.

### Interior lamp AUTO cut

- When all entrances are closed, if you lock the vehicle by using the transmitter or the smart key, all interior lamp will be off within 5 seconds.
- If you do not operate anything in the vehicle after turning off the engine, the lights will turn off after 20 minutes.

امداد خودرو فارما

تلفن شبانه روزی: ۰۲۱-۸۸۸۶۲۰۸۵

FarmaSOS.com

### Map lamp

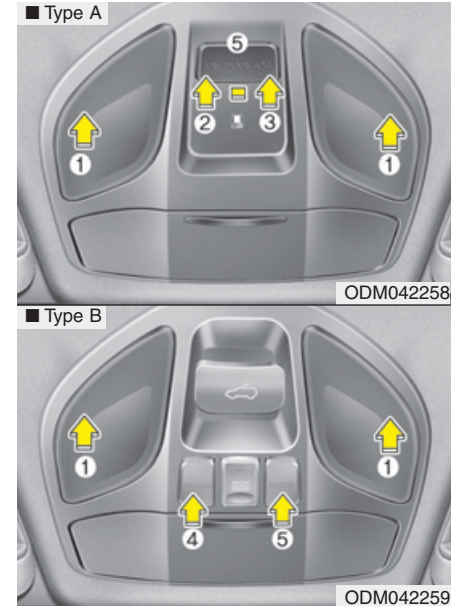

Press the lens (1) to turn the map lamp on or off

- ON (2): The map lamp and room lamp stays on at all times.
- OFF (3): The lamps are off even if a door is opened.

- ROOM (4): The map lamp and room lamp stays on at all times.
- DOOR (5):
  - The map lamp and room lamp comes on when door are unlocked with a transmitter or smart key as long as the doors are closed. The lamps go out after approximately 30 seconds.
  - The map lamp and room lamp comes on for approximately 30 seconds when doors are unlocked with a transmitter or smart key as long as the doors are not opened.
  - The map lamp and room lamp will stay on for approximately 20 minutes if a door is opened with the ignition switch in the ACC or LOCK/OFF position.
  - The map lamp and room lamp will stay on continuously if the door is opened with the ignition switch in the ON position.
  - The map lamp and room lamp will go out immediately if the ignition switch is changed to the ON position or all doors are locked.

**\* NOTICE**

When the lamp is turned on by pressing the lens (1), the lamp does not turn off even if the switch is in the OFF position (3).

امداد خودرو فارما

تلفن شبانه روزی: ۰۲۱-۸۸۸۶۲۰۸۵

FarmaSOS.com

**Room lamp**

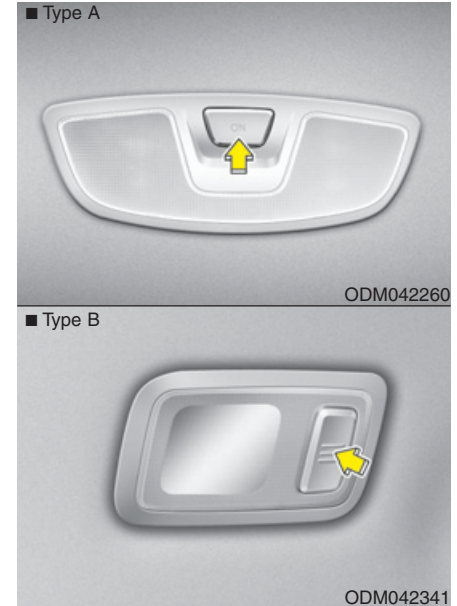

Press the button to turn the light on or off.

### Vanity mirror lamp



Push the switch to turn the light on or off.

- ☀️ : The lamp will turn on if this button is pressed.
- ○ : The lamp will turn off if this button is pressed.



### CAUTION - Vanity mirror lamp

*Always have the switch in the off position when the vanity mirror lamp is not in use. If the sunvisor is closed without the lamp off, it may discharge the battery or damage the sunvisor.*

امداد خودرو فارما

تلفن شبانه روزی: ۰۲۱-۸۸۸۶۲۰۸۵

FarmaSOS.com

### Luggage room lamp

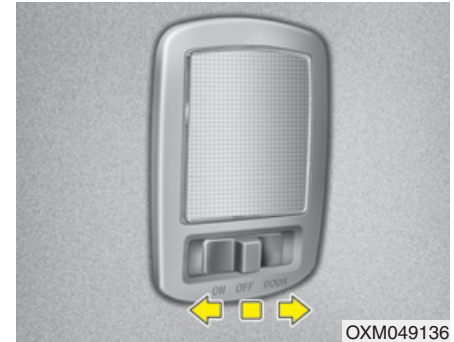

- ON : The luggage room lamp stays on at all times.
- DOOR : The luggage room lamp comes on when the tailgate is opened.
- OFF : The luggage room lamp is off.

### Glove box lamp

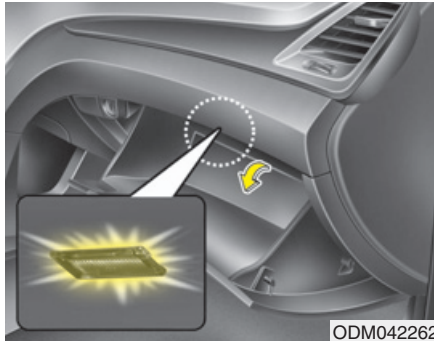

ODM042262

The glove box lamp comes on when the light switch is in the parking light position or headlight position and the glove box is opened.

### Door courtesy lamp (if equipped)

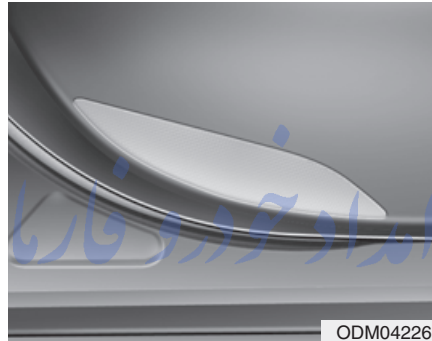

ODM042261

The door courtesy lamp comes ON when the door is opened to assist entering or exiting the vehicle. It also serves as a warning to passing vehicles that the vehicle door is open.



## WELCOME SYSTEM (IF EQUIPPED)

### Headlamp welcome

When the headlight(light switch in the headlight or AUTO position) is on and all doors (and tailgate) are locked and closed, the headlight, position light and tail light will come on for 15 seconds if any of the below is performed.

- Without smart key system
  - When the door unlock button is pressed on the transmitter.
- With the smart key system
  - When the door unlock button is pressed on the smart key.

At this time, if you press the door lock button (on the transmitter or smart key), the lights will turn off immediately.

### Interior light

When the interior light switch is in the DOOR position and all doors (and tailgate) are locked and closed, the room lamp will come on for 30 seconds if any of the below is performed.

- Without smart key system
  - When the door unlock button is pressed on the transmitter.
- With the smart key system
  - When the door unlock button is pressed on the smart key.
  - When the button of the outside door handle is pressed.

At this time, if you press the door lock button, the lamps will turn off immediately.

### Puddle lamp and pocket lamp (if equipped)

When all doors are locked and closed, the puddle lamp and pocket lamp will come on for 15 seconds if any of the below is performed.

- Without smart key system
  - When the door unlock button is pressed on the transmitter.
- With the smart key system
  - When the door unlock button is pressed on the smart key.
  - When the button of the outside door handle is pressed.
  - When the vehicle is approached with the smart key in possession.

At this time, if you press the door lock button, the lamps will turn off immediately.

### \* NOTICE

The puddle lamp and pocket lamp do not operate when the outside rearview mirror folding switch is in the fold position.

## DEFROSTER

### ⚠ CAUTION

*To prevent damage to the conductors bonded to the inside surface of the rear window, never use sharp instruments or window cleaners containing abrasives to clean the window.*

### \* NOTICE

If you want to defrost and defog the front windshield, refer to “Windshield Defrosting and Defogging” in this section.

### Rear window defroster

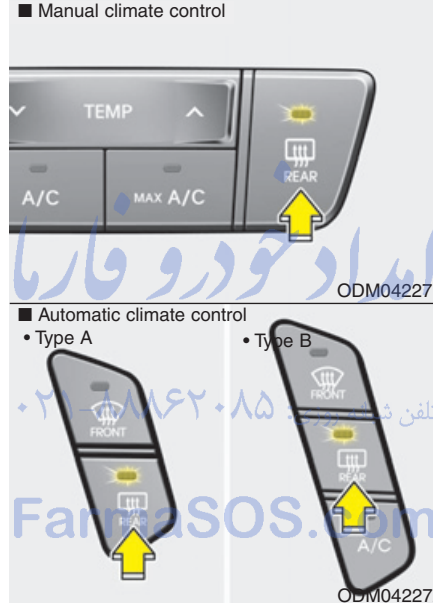

The defroster heats the window to remove frost, fog and thin ice from the interior and exterior of the rear window, while engine is running.

- To activate the rear window defroster, press the rear window defroster button located in the center facia switch panel. The indicator on the rear window defroster button illuminates when the defroster is ON.
- To turn off the defroster, press the rear window defroster button again.

### \* NOTICE

- If there is heavy accumulation of snow on the rear window, brush it off before operating the rear defroster.
- The rear window defroster automatically turns off after approximately 20 minutes or when the ignition switch is turned off.

### ***Outside mirror defroster (if equipped)***

The outside mirror defroster will operate at the same time you turn on the rear window defroster.

### ***Front wiper deicer (if equipped)***

The front wiper deicer will operate at the same time you turn on the front windshield defroster.

امداد خودرو فارما

تلفن شبانه روزی: ۰۲۱-۸۸۸۶۲۰۸۵

FarmaSOS.com

## MANUAL CLIMATE CONTROL SYSTEM (IF EQUIPPED)

### ■ Type A



### ■ Type B



1. Fan speed control knob
2. Mode selection button
3. Air intake control button
4. Air conditioning button\*
5. Temperature control switch
6. Front windshield defroster button
7. Rear window defroster button
8. MAX A/C (Max air conditioning) button\*
9. 3rd row seat Air conditioning button\*
10. 3rd row seat Air conditioning Fan speed control lever\*

تلفن شبانه روزی: ۰۲۱-۸۸۶۲۰۸۵

\*: if equipped

### ■ 3rd row air conditioning control (for Type B climate control)

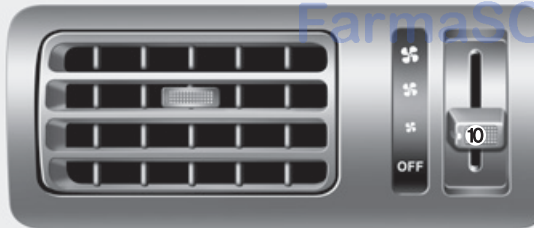



### CAUTION

*Operating the blower when the ignition switch is in the ON position could cause the battery to discharge. Operate the blower when the engine is running.*

ODM042273/ODM042274/OXM049141

### Heating and air conditioning

1. Start the engine.
2. Set the mode to the desired position.  
For improving the effectiveness of heating and cooling;
  - Heating: 
  - Cooling: 
3. Set the temperature control to the desired position.
4. Set the air intake control to the outside (fresh) air position.
5. Set the fan speed control to the desired speed.
6. If air conditioning is desired, turn the air conditioning system (if equipped) on.

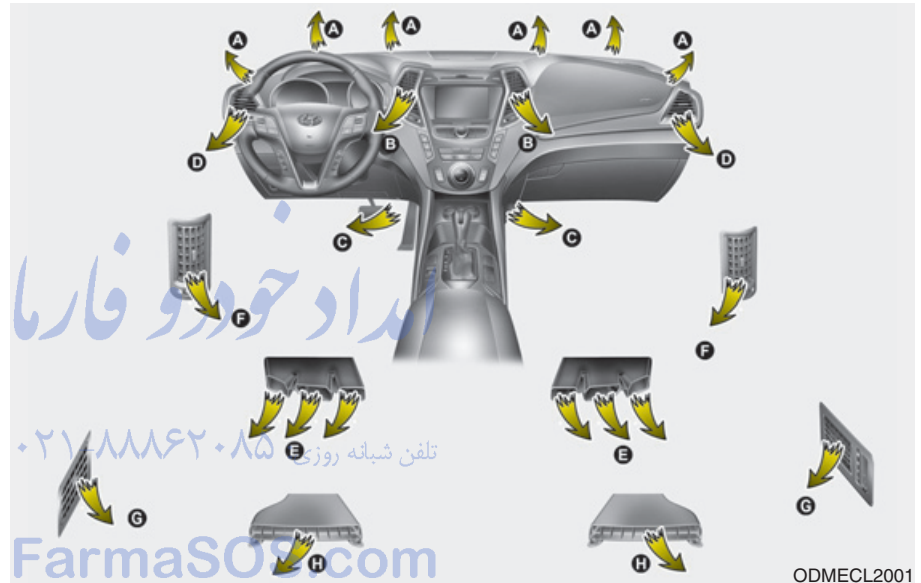

#### ※ 2nd and 3rd row outlet vents (E, F, G, H) (Vent G, H : if equipped)

- The air flow of the 2nd and 3rd row outlet vents is controlled by the front climate control system and delivered through the inside air duct of the floor (E, F, H).
- The air flow of the 2nd and 3rd row outlet vents (E, F, H) may be weaker than the instrument panel vents for the long air duct.
- Close the air vents (F) in cold weather. The air flow of the 2nd and 3rd row outlet vents may cool a little during heating operation. (Use the 2nd and 3rd row outlet vents (F, G) during cooling operation.)

**Mode selection**

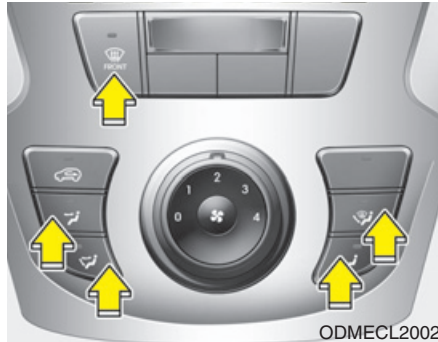

The mode buttons control the direction of the air flow through the ventilation system.

Air can be directed to the floor, dashboard outlets, or windshield. Five symbols are used to represent Face, Bi-Level, Floor, Floor-Defrost and Defrost air position.



**Face-Level (B, D, F)**

Air flow is directed toward the upper body and face. Additionally, each outlet can be controlled to direct the air discharged from the outlet.



**Bi-Level (B, C, D, E, F, H)**

Air flow is directed towards the face and the floor.



**Floor-Level (A, C, D, E, H)**

Most of the air flow is directed to the floor, with a small amount of the air being directed to the windshield and side window defrosters.



**Floor/Defrost-Level (A, C, D, E, H)**

Most of the air flow is directed to the floor and the windshield with a small amount directed to the side window defrosters.



**Defrost-Level (A, D)**

Most of the air flow is directed to the windshield with a small amount of air directed to the side window defrosters.

اراد جودونفا  
۰۲۱-۸۸۸۶۲۰۸۵  
تلفن شبانه روزی:

FarmaSOS.com

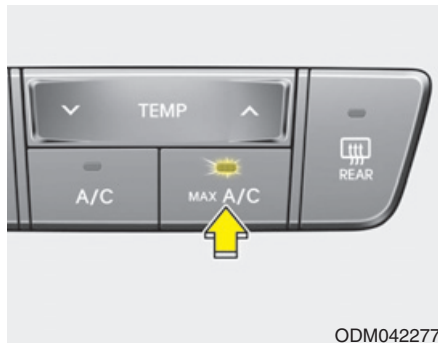

### MAX A/C-Level (if equipped)

To select the MAX A/C, turn the fan speed control knob to the right then press the MAX A/C button.

Air flow is directed toward the upper body and face.

In this mode, the air conditioning and the recirculated air position will be selected automatically.

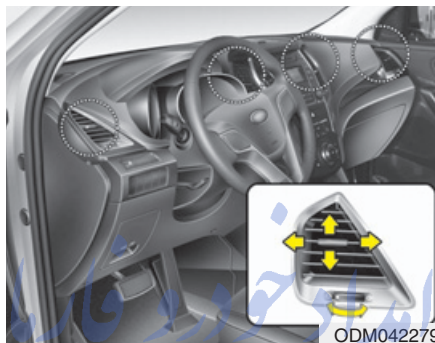

### Instrument panel vents

The outlet vents can be opened or closed separately using the thumb-wheel.

Also, you can adjust the direction of air delivery from these vents using the vent control lever as shown.

### Temperature control

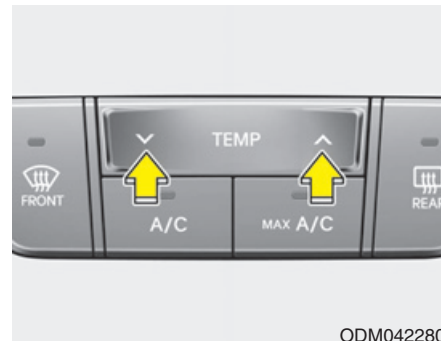

The temperature control switch allows you to control the temperature of the airflow in the vehicle.

To change the temperature:

- Press the ^ (red) switch to increase temperature.
- Press the v (blue) switch to decrease temperature.

The temperature status will be displayed at the above switch panel as an indicator.

## Air intake control

### ■ Type A

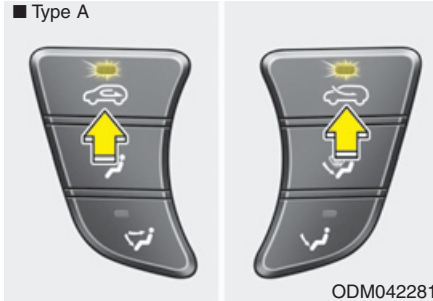

### ■ Type B

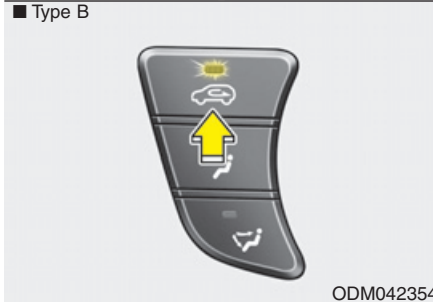

The air intake control is used to select the outside (fresh) air position or recirculated air position.

To change the air intake control position, press the control button.

### Type A

#### Recirculated air position



With the recirculated air position selected, air from the passenger compartment will be drawn through the heating system and heated or cooled according to the function selected.

#### Outside (fresh) air position



With the outside (fresh) air position selected, air enters the vehicle from outside and is heated or cooled according to the function selected.

### Type B

#### Recirculated air position



With the recirculated air position selected, air from the passenger compartment will be drawn through the heating system and heated or cooled according to the function selected.

#### Outside (fresh) air position



With the outside (fresh) air position selected, air enters the vehicle from outside and is heated or cooled according to the function selected.

FarmaSOS.com



### \* NOTICE

Prolonged operation of the heater in the recirculated air position (without air conditioning selected) may cause fogging of the windshield and side windows and the air within the passenger compartment may become stale.

In addition, prolonged use of the air conditioning with the recirculated air position selected will result in excessively dry air in the passenger compartment.

### ⚠ WARNING

- Continue using the climate control system in the recirculated air position may allow humidity to increase inside the vehicle which may fog the glass and obscure visibility.
- Do not sleep in a vehicle with the air conditioning or heating system on. It may cause serious harm or death due to a drop in the oxygen level and/or body temperature.
- Continue using the climate control system in the recirculated air position can cause drowsiness or sleepiness, and loss of vehicle control. Set the air intake control to the outside (fresh) air position as much as possible while driving.

### Fan speed control



The ignition switch must be in the ON position for fan operation.

The fan speed control knob allows you to control the fan speed of the air flowing from the ventilation system. To change the fan speed, turn the knob to the right for higher speed or left for lower speed.

Setting the fan speed control knob to the “0” position turns off the fan.

**To turn off the blowers**



To turn off the blowers, turn the fan speed control knob to the "0" position.

**Air conditioning (if equipped)**

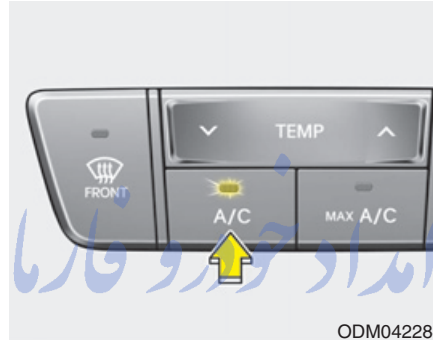

Press the A/C button to turn the air conditioning system on (indicator light will illuminate). Press the button again to turn the air conditioning system off.

FarmaSOS.com

**3rd row air conditioning (if equipped)**

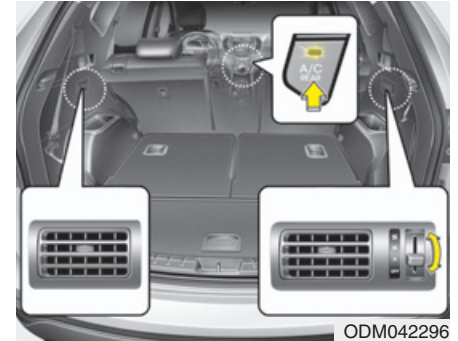

To turn on the 3rd row air conditioning control system

1. Press the 3rd row air conditioning ON/OFF button located on the front climate control panel and set the fan speed to the desired speed with the 3rd row fan speed switch. (indicator light on the ON/OFF button will illuminate).



2. To turn off the 3rd row air conditioning control system, press the 3rd row air conditioning ON/OFF button once more located on the front climate control panel or set the fan speed to the OFF position with the 3rd row fan speed switch (indicator light on the ON/OFF button is not illuminated).

### System operation

#### Ventilation

1. Set the mode to the  position.
2. Set the air intake control to the outside (fresh) air position.
3. Set the temperature control to the desired position.
4. Set the fan speed control to the desired speed.

#### Heating

1. Set the mode to the  position.
  2. Set the air intake control to the outside (fresh) air position.
  3. Set the temperature control to the desired position.
  4. Set the fan speed control to the desired speed.
  5. If dehumidified heating is desired, turn the air conditioning system (if equipped) on.
- If the windshield fogs up, set the mode to the  or  position.

### Operation Tips

- To keep dust or unpleasant fumes from entering the vehicle through the ventilation system, temporarily set the air intake control to the recirculated air position. Be sure to return the control to the fresh air position when the irritation has passed to keep fresh air in the vehicle. This will help keep the driver alert and comfortable.
- Air for the heating/cooling system is drawn in through the grilles just ahead of the windshield. Care should be taken that these are not blocked by leaves, snow, ice or other obstructions.
- To prevent interior fog on the windshield, set the air intake control to the fresh air position and fan speed to the desired position, turn on the air conditioning system, and adjust the temperature control to desired temperature.

**Air conditioning (if equipped)**

HYUNDAI Air Conditioning Systems are filled with environmentally friendly refrigerant\*.

1. Start the engine. Push the air conditioning button.
2. Set the mode to the  position.
3. Set the air intake control to the outside air or recirculated air position.
4. Adjust the fan speed control and temperature control to maintain maximum comfort.

\*: Your vehicle is filled with R-134a or R-1234yf according to the regulation in your country at the time of producing. You can find out which air conditioning refrigerant is applied your vehicle at the label inside of the engine room. Refer to section 8 for more detail location of air conditioning refrigerant label.

**⚠ CAUTION**

- *The refrigerant system should only be serviced by trained and certified technicians to insure proper and safe operation.*
- *The refrigerant system should be serviced in a well-ventilated place.*
- *The air conditioning evaporator (cooling coil) shall never be repaired or replaced with one removed from a used or salvaged vehicle and new replacement MAC evaporators shall be certified (and labeled) as meeting SAE Standard J2842.*

FarmaSOS.com

**\* NOTICE**

- When using the air conditioning system, monitor the temperature gauge closely while driving up hills or in heavy traffic when outside temperatures are high. Air conditioning system operation may cause engine overheating. Continue to use the blower fan but turn the air conditioning system off if the temperature gauge indicates engine overheating.
- When opening the windows in humid weather air conditioning may create water droplets inside the vehicle. Since excessive water droplets may cause damage to electrical equipment, air conditioning should only be used with the windows closed.

### Air conditioning system operation tips

- If the vehicle has been parked in direct sunlight during hot weather, open the windows for a short time to let the hot air inside the vehicle escape.
- Use air conditioning to reduce humidity and moisture inside the vehicle on rainy or humid days.
- During air conditioning system operation, you may occasionally notice a slight change in engine speed as the air conditioning compressor cycles. This is a normal system operation characteristic.
- Use the air conditioning system every month only for a few minutes to ensure maximum system performance.

- When using the air conditioning system, you may notice clear water dripping (or even puddling) on the ground under the passenger side of the vehicle. This is a normal system operation characteristic.
- Operating the air conditioning system in the recirculated air position provides maximum cooling, however, continual operation in this mode may cause the air inside the vehicle to become stale.
- During cooling operation, you may occasionally notice a misty air flow because of rapid cooling and humid air intake. This is a normal system operation characteristic.

FarmaSOS.com

### Climate control air filter

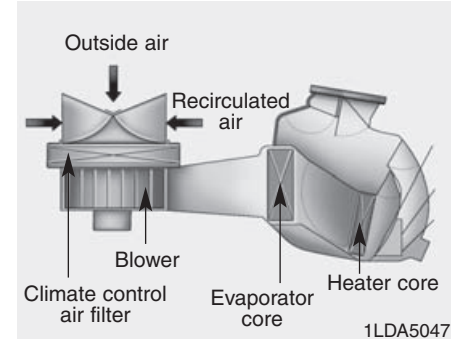

The climate control air filter installed behind the glove box filters the dust or other pollutants that come into the vehicle from the outside through the heating and air conditioning system. If dust or other pollutants accumulate in the filter over a period of time, the air flow from the air vents may decrease, resulting in moisture accumulation on the inside of the windshield even when the outside (fresh) air position is selected. If this happens, we recommend that the climate control air filter be replaced by an authorized HYUNDAI dealer.

**\* NOTICE**

- Replace the filter according to the Maintenance Schedule. If the car is being driven in severe conditions such as dusty, rough roads, more frequent climate control air filter inspections and changes are required.
- When the air flow rate suddenly decreases, we recommend that the system be checked by an authorized HYUNDAI dealer.

**Air Conditioning refrigerant label**

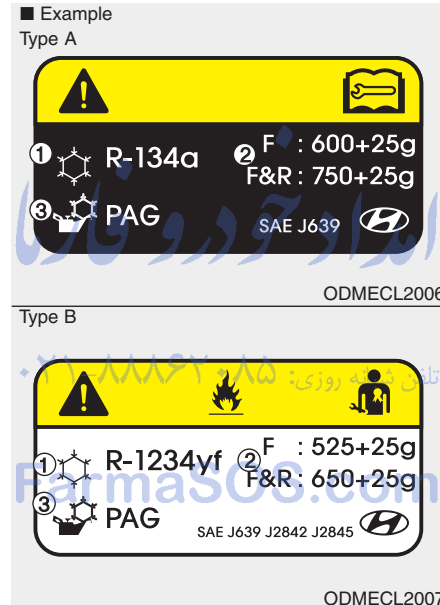

Each symbols and specification on air conditioning refrigerant label means as below ;

1. Classification of refrigerant
2. Amount of refrigerant
3. Classification of Compressor lubricant

You can find out which air conditioning refrigerant is applied your vehicle at the label inside of the engine room. Refer to section 8 for more detail location of air conditioning refrigerant label.

\* The actual Air Conditioning refrigerant label in the vehicle may differ from the illustration.

### Checking the amount of air conditioner refrigerant and compressor lubricant

When the amount of refrigerant is low, the performance of the air conditioning is reduced. Overfilling also has a bad influence on the air conditioning system.

Therefore, if abnormal operation is found, we recommend that the system be inspected by an authorized HYUNDAI dealer.

#### **WARNING - Vehicles equipped with R-134a\***



Because the refrigerant is at very high pressure, the air conditioning system should only be serviced by trained and certified technicians. It is important that the correct type and amount of oil and refrigerant is used.

Otherwise, it may cause damage to the vehicle and personal injury.

#### **WARNING - Vehicles equipped with R-1234yf\***



Because the refrigerant is mildly inflammable and at very high pressure, the air conditioning system should only be serviced by trained and certified technicians.

It is important that the correct type and amount of oil and refrigerant is used.

Otherwise, it may cause damage to the vehicle and personal injury.

\*: Your vehicle is filled with R-134a or R-1234yf according to the regulation in your country at the time of producing.

## AUTOMATIC CLIMATE CONTROL SYSTEM (IF EQUIPPED)

### ■ Type A



### ■ Type B



1. A/C display
2. AUTO (automatic control) button
3. Front blower OFF button
4. Air conditioning button\*
5. Driver's temperature control button
6. Front fan speed control knob
7. Air intake control button
8. Passenger's temperature control button
9. Mode selection button
10. Dual temperature control selection button
11. Front windshield defroster button
12. Rear window defroster button
13. 3rd row air conditioning ON/OFF button\* (controlled from the front)
14. 3rd row air conditioning fan speed control lever\*

### ■ 3rd row air conditioning control (for Type A climate control)



\* if equipped



### CAUTION

**Operating the blower when the ignition switch is in the ON position could cause the battery to discharge. Operate the blower when the engine is running.**

ODM042285/ODMECL2010/OXM049141



## ■ Type C



## ■ Type D



1. AUTO (automatic control) button
2. Front blower OFF button
3. Air conditioning button\*
4. Driver's temperature control button
5. Front fan speed control knob
6. Air intake control button
7. Passenger's temperature control button
8. Mode selection button
9. Dual temperature control selection button
10. Front windshield defroster button
11. Rear window defroster button
12. 3rd row air conditioning ON/OFF button\* (controlled from the front)
13. Climate control information screen selection button
14. 3rd row air conditioning fan speed control lever\*

\* if equipped

## ■ 3rd row air conditioning control (for Type D climate control)



### **⚠ CAUTION**

**Operating the blower when the ignition switch is in the ON position could cause the battery to discharge. Operate the blower when the engine is running.**

ODMECL2011/ODM042286/OXM049141

## Automatic heating and air conditioning



ODM042287

1 Press the AUTO button.

The modes, fan speeds, air intake and air-conditioning will be controlled automatically by setting the temperature.



ODM042290

2. Set the Driver's temperature control switch to the desired temperature.

تلفن شبانه روزی: ۰۲۱-۸۸۸۶۲۰۸۵

FarmaSOS.com

### \* NOTICE

- To turn the automatic operation off, select any button or switch of the following:
  - Mode selection button
  - Air conditioning button
  - Front windshield defroster button
  - Air intake control button
  - Fan speed control switch
 The selected function will be controlled manually while other functions operate automatically.
- For your convenience and to improve the effectiveness of the climate control, use the AUTO button and set the temperature to 22°C/71°F (23°C/73°F - Except Europe).

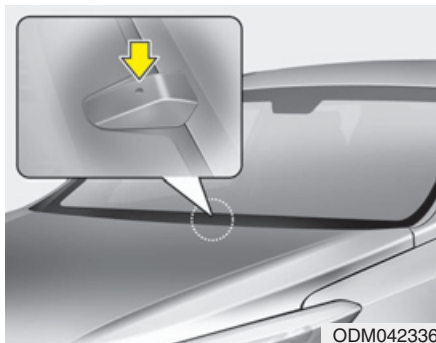

### \* NOTICE

Never place anything over the sensor located on the instrument panel to ensure better control of the heating and cooling system.

### Manual heating and air conditioning

The heating and cooling system can be controlled manually by pressing buttons or turning knob(s) other than the AUTO button. In this case, the system works sequentially according to the order of buttons or knob(s) selected.

1. Start the engine.
2. Set the mode to the desired position.

For improving the effectiveness of heating and cooling;

- Heating:
- Cooling:

3. Set the temperature control to the desired position.
4. Set the air intake control to the outside (fresh) air position.
5. Set the fan speed control to the desired speed.
6. If air conditioning is desired, turn the air conditioning system on.

Press the AUTO button in order to convert to full automatic control of the system.

### Mode selection

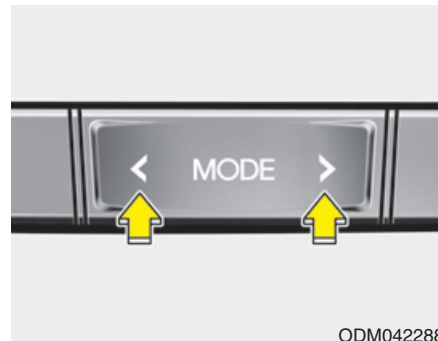

The mode selection button controls the direction of the air flow through the ventilation system.

The air flow outlet port is converted as follows:



Refer to the illustration in the "Manual climate control system".



### Face-Level

Air flow is directed toward the upper body and face. Additionally, each outlet can be controlled to direct the air discharged from the outlet.



### Bi-Level

Air flow is directed towards the face and the floor.



### Floor-Level

Most of the air flow is directed to the floor, with a small amount of the air being directed to the windshield and side window defrosters.



### Floor/Defrost-Level

Most of the air flow is directed to the floor and the windshield with a small amount directed to the side window defrosters.

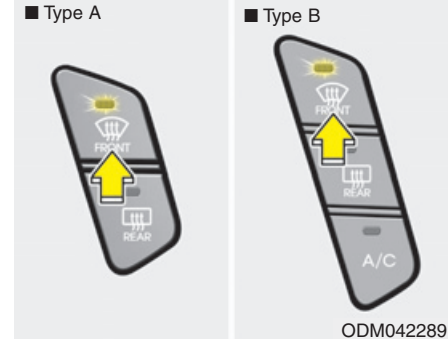

### Defrost-Level

Most of the air flow is directed to the windshield with a small amount of air directed to the side window defrosters.

FarmaSOS.com

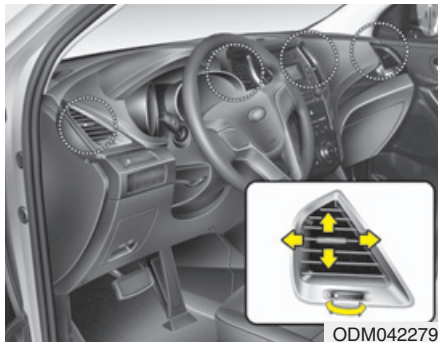

### Instrument panel vents

The outlet vents can be opened or closed separately using the thumb-wheel.

Also, you can adjust the direction of air delivery from these vents using the vent control lever as shown.

### Temperature control

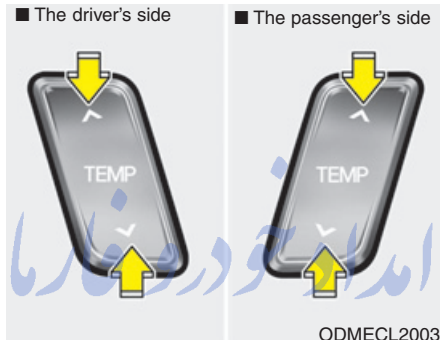

The temperature will increase to the maximum (HIGH) by holding the  $\blacktriangle$  button.

The temperature will decrease to the minimum (LOW) by holding the  $\blacktriangledown$  button.

The temperature will increase or decrease by  $0.5^{\circ}\text{C}/1^{\circ}\text{F}$ . When set to the lowest temperature, the air conditioning will operate continuously.

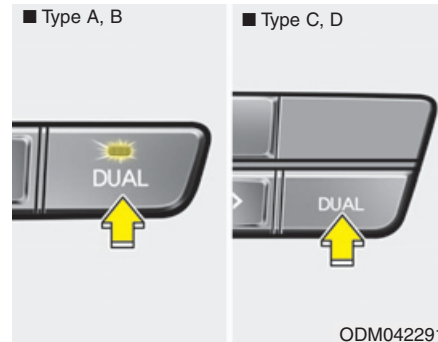

### Adjusting the driver and passenger side temperature individually

1. Press the DUAL button to operate the driver and passenger side temperature individually. Also, if the passenger side temperature control button is operated, it will automatically change to the DUAL mode as well.
2. Operate the driver side temperature control to adjust the driver side temperature. Operate the passenger side temperature control to adjust the passenger side temperature.

When the driver side temperature is set to the highest (HIGH) or lowest (LOW) temperature, the DUAL mode deactivates for maximum heating or cooling.

#### Adjusting the driver and passenger side temperature equally

1. Press the DUAL button again to deactivate DUAL mode. The passenger side temperature will be set to the same temperature as the driver side.
2. Operate the driver side temperature control button. The driver and passenger side temperature will be adjusted equally.

#### Temperature conversion

You can switch the temperature mode between Centigrade to Fahrenheit as follows:

While pressing the OFF button, press the AUTO button for 3 seconds or more.

The display will change from Centigrade to Fahrenheit, or from Fahrenheit to Centigrade.

#### Air intake control

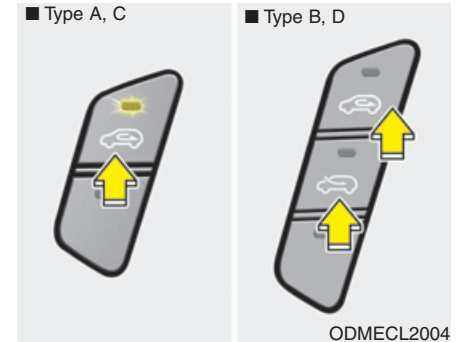

The air intake control is used to select the outside (fresh) air position or recirculated air position.

To change the air intake control position, press the control button.

### *Type A, C*

#### **Recirculated air position**



With the recirculated air position selected, air from the passenger compartment will be drawn through the heating system and heated or cooled according to the function selected.

#### **Outside (fresh) air position**



With the outside (fresh) air position selected, air enters the vehicle from outside and is heated or cooled according to the function selected.

### *Type B, D*

#### **Recirculated air position**



With the recirculated air position selected, air from the passenger compartment will be drawn through the heating system and heated or cooled according to the function selected.

#### **Outside (fresh) air position**



With the outside (fresh) air position selected, air enters the vehicle from outside and is heated or cooled according to the function selected.

### **\* NOTICE**

Prolonged operation of the heater in the recirculated air position (without air conditioning selected) may cause fogging of the windshield and side windows and the air within the passenger compartment may become stale.

In addition, prolonged use of the air conditioning with the recirculated air position selected will result in excessively dry air in the passenger compartment.

**⚠ WARNING**

- Continue using the climate control system in the recirculated air position may allow humidity to increase inside the vehicle which may fog the glass and obscure visibility.
- Do not sleep in a vehicle with the air conditioning or heating system on. It may cause serious harm or death due to a drop in the oxygen level and/or body temperature.
- Continue using the climate control system in the recirculated air position can cause drowsiness or sleepiness, and loss of vehicle control. Set the air intake control to the outside (fresh) air position as much as possible while driving.

**Fan speed control**

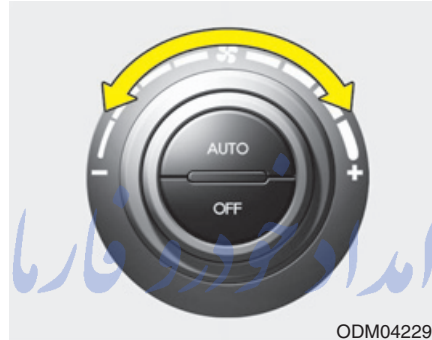

The fan speed control knob allows you to control the fan speed of the airflow in the vehicle.

To change the fan speed:

- Turn the knob to the right (+) to increase fan speed.
- Turn the knob to the left (-) to decrease fan speed.

To turn off the fan speed, press the OFF button.

**Air conditioning**

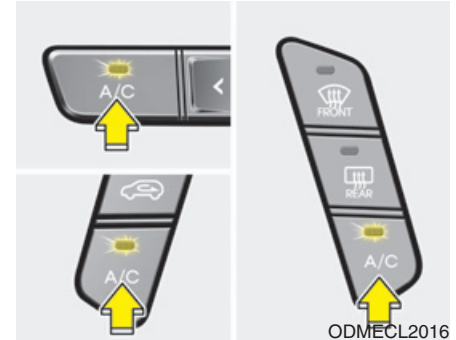

Press the A/C button to turn the air conditioning system on (indicator light will illuminate).

Press the button again to turn the air conditioning system off.



### OFF mode (for 1st and 2nd row)



ODM042295

Press the front blower OFF button to turn off the front air climate control system. However, you can still operate the mode and air intake buttons as long as the ignition switch is in the ON position.

### Climate information screen selection (for type C, D)

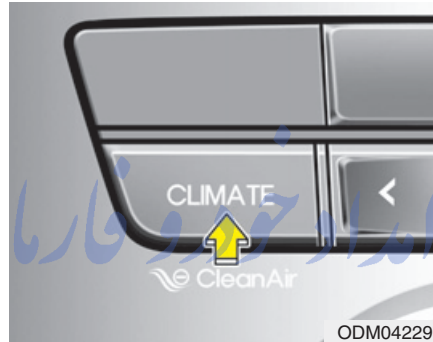

ODM042297

Press the climate information screen selection button to display climate information on the screen.

FarmaSOS.com

### 3rd row air conditioning (if equipped)

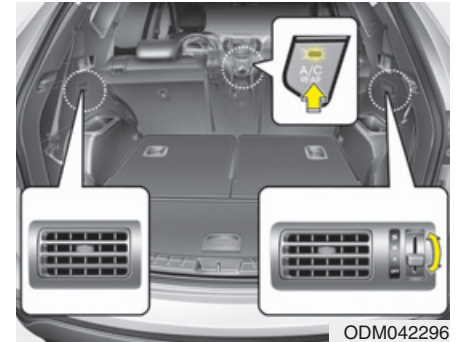

ODM042296

To turn on the 3rd row air conditioning control system

1. Press the 3rd row air conditioning ON/OFF button located on the front climate control panel and set the fan speed to the desired speed with the 3rd row fan speed switch. (indicator light on the ON/OFF button will illuminate).



2. To turn off the 3rd row air conditioning control system, press the 3rd row air conditioning ON/OFF button once more located on the front climate control panel or set the fan speed to the OFF position with the 3rd row fan speed switch (indicator light on the ON/OFF button is not illuminated).

## System operation

### Ventilation

1. Set the mode to the  position.
2. Set the air intake control to the outside (fresh) air position.
3. Set the temperature control to the desired position.
4. Set the fan speed control to the desired speed.

### Heating

1. Set the mode to the  position.
  2. Set the air intake control to the outside (fresh) air position.
  3. Set the temperature control to the desired position.
  4. Set the fan speed control to the desired speed.
  5. If dehumidified heating is desired, turn the air conditioning system (if equipped) on.
- If the windshield fogs up, set the mode to the  or  position.

## Operation Tips

- To keep dust or unpleasant fumes from entering the vehicle through the ventilation system, temporarily set the air intake control to the recirculated air position. Be sure to return the control to the fresh air position when the irritation has passed to keep fresh air in the vehicle. This will help keep the driver alert and comfortable.
- Air for the heating/cooling system is drawn in through the grilles just ahead of the windshield. Care should be taken that these are not blocked by leaves, snow, ice or other obstructions.
- To prevent interior fog on the windshield, set the air intake control to the fresh air position and fan speed to the desired position, turn on the air conditioning system, and adjust the temperature control to desired temperature.

### **Air conditioning (if equipped)**

HYUNDAI Air Conditioning Systems are filled with environmentally friendly refrigerant\*.

1. Start the engine. Push the air conditioning button.
2. Set the mode to the  position.
3. Set the air intake control to the outside air or recirculated air position.
4. Adjust the fan speed control and temperature control to maintain maximum comfort.

\*: Your vehicle is filled with R-134a or R-1234yf according to the regulation in your country at the time of producing. You can find out which air conditioning refrigerant is applied your vehicle at the label inside of hood. Refer to section 8 for more detail location of air conditioning refrigerant label.

### **CAUTION**

- ***The refrigerant system should only be serviced by trained and certified technicians to insure proper and safe operation.***
- ***The refrigerant system should be serviced in a well-ventilated place.***
- ***The air conditioning evaporator (cooling coil) shall never be repaired or replaced with one removed from a used or salvaged vehicle and new replacement MAC evaporators shall be certified (and labeled) as meeting SAE Standard J2842.***

FarmaSOS.com

### **\* NOTICE**

- When using the air conditioning system, monitor the temperature gauge closely while driving up hills or in heavy traffic when outside temperatures are high. Air conditioning system operation may cause engine overheating. Continue to use the blower fan but turn the air conditioning system off if the temperature gauge indicates engine overheating.
- When opening the windows in humid weather air conditioning may create water droplets inside the vehicle. Since excessive water droplets may cause damage to electrical equipment, air conditioning should only be used with the windows closed.

### Air conditioning system operation tips

- If the vehicle has been parked in direct sunlight during hot weather, open the windows for a short time to let the hot air inside the vehicle escape.
- Use air conditioning to reduce humidity and moisture inside the vehicle on rainy or humid days.
- During air conditioning system operation, you may occasionally notice a slight change in engine speed as the air conditioning compressor cycles. This is a normal system operation characteristic.
- Use the air conditioning system every month only for a few minutes to ensure maximum system performance.

- When using the air conditioning system, you may notice clear water dripping (or even puddling) on the ground under the passenger side of the vehicle. This is a normal system operation characteristic.
- Operating the air conditioning system in the recirculated air position provides maximum cooling, however, continual operation in this mode may cause the air inside the vehicle to become stale.
- During cooling operation, you may occasionally notice a misty air flow because of rapid cooling and humid air intake. This is a normal system operation characteristic.

FarmaSOS.com

### Climate control air filter

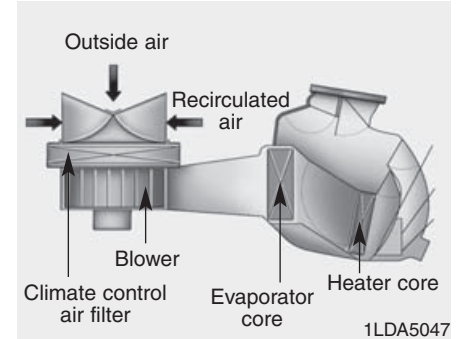

The climate control air filter installed behind the glove box filters the dust or other pollutants that come into the vehicle from the outside through the heating and air conditioning system. If dust or other pollutants accumulate in the filter over a period of time, the air flow from the air vents may decrease, resulting in moisture accumulation on the inside of the windshield even when the outside (fresh) air position is selected. If this happens, we recommend that the climate control air filter be replaced by an authorized HYUNDAI dealer.

### \* NOTICE

- Replace the filter according to the Maintenance Schedule.  
If the car is being driven in severe conditions such as dusty, rough roads, more frequent climate control air filter inspections and changes are required.
- When the air flow rate suddenly decreases, we recommend that the system be checked by an authorized HYUNDAI dealer.

### Air Conditioning refrigerant label

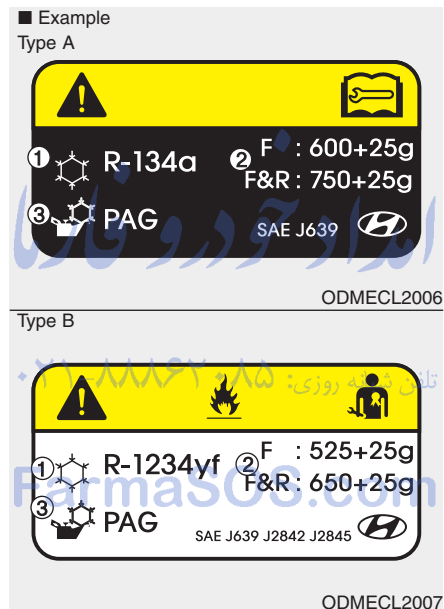

- \* The actual Air Conditioning refrigerant label in the vehicle may differ from the illustration.

Each symbols and specification on air conditioning refrigerant label means as below ;

1. Classification of refrigerant
2. Amount of refrigerant
3. Classification of Compressor lubricant

You can find out which air conditioning refrigerant is applied your vehicle at the label inside of the engine room. Refer to section 8 for more detail location of air conditioning refrigerant label.

## Checking the amount of air conditioner refrigerant and compressor lubricant

When the amount of refrigerant is low, the performance of the air conditioning is reduced. Overfilling also has a bad influence on the air conditioning system.

Therefore, if abnormal operation is found, we recommend that the system be inspected by an authorized HYUNDAI dealer.

### **⚠ WARNING - Vehicles equipped with R-134a\***



Because the refrigerant is at very high pressure, the air conditioning system should only be serviced by trained and certified technicians. It is important that the correct type and amount of oil and refrigerant is used.

Otherwise, it may cause damage to the vehicle and personal injury.

### **⚠ WARNING - Vehicles equipped with R-1234yf\***





Because the refrigerant is mildly inflammable and at very high pressure, the air conditioning system should only be serviced by trained and certified technicians. It is important that the correct type and amount of oil and refrigerant is used.

Otherwise, it may cause damage to the vehicle and personal injury.

\*: Your vehicle is filled with R-134a or R-1234yf according to the regulation in your country at the time of producing.

## WINDSHIELD DEFROSTING AND DEFOGGING

### **⚠ WARNING - Windshield heating**

Do not use the  or  position during cooling operation in extremely humid weather. The difference between the temperature of the outside air and the windshield could cause the outer surface of the windshield to fog up, causing loss of visibility. In this case, set the mode selection to the  position and fan speed control to the lower speed.



- For maximum defrosting, set the temperature control to the extreme right/hot position and the fan speed control to the highest speed.
- If warm air to the floor is desired while defrosting or defogging, set the mode to the floor-defrost position.
- Before driving, clear all snow and ice from the windshield, rear window, outside rear view mirrors, and all side windows.
- Clear all snow and ice from the hood and air inlet in the cowl grill to improve heater and defroster efficiency and to reduce the probability of fogging up the inside of the windshield.

FarmaSOS.com

### Manual climate control system

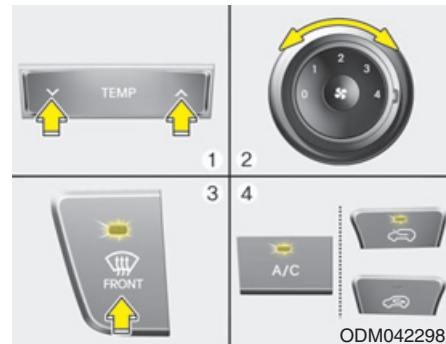
#### *To defog inside windshield*



1. Select desired temperature.
2. Set the fan speed to the desired position.
3. Select the  or  position.
4. The outside (fresh) air will be selected automatically. If the  position is selected, air conditioning will also be selected automatically.

If the air conditioning and/or outside (fresh) air position are not selected automatically, press the corresponding button manually.

**To defrost outside windshield**

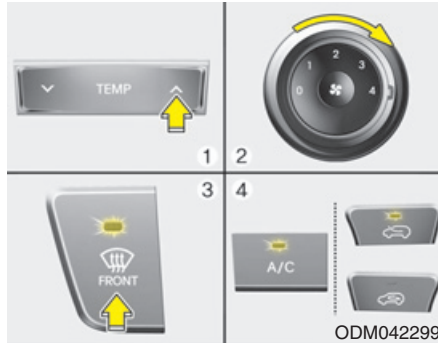

1. Set the temperature to the extreme hot position.
2. Set the fan speed to the highest position.
3. Select the position.
4. The outside (fresh) air and air conditioning will be selected automatically.

**Automatic climate control system**

**To defog inside windshield**

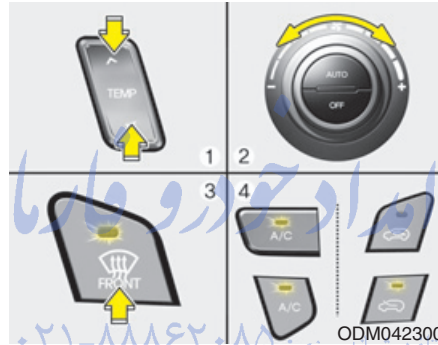



1. Select desired temperature.
2. Set the fan speed to the desired position.
3. Press the defroster button ().
4. The air conditioning will turn on according to the detected ambient temperature and outside (fresh) air position will be selected automatically.

If the air conditioning and outside (fresh) air position are not selected automatically, adjust the corresponding button manually. If the position is selected, lower fan speed is adjusted to a higher fan speed.

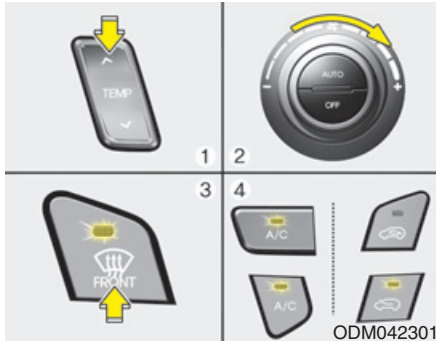

### To defrost outside windshield



1. Set the temperature to the extreme hot (HI) position.
2. Set the fan speed to the highest position.
3. Press the defroster button (  ).
4. The air conditioning will turn on according to the detected ambient temperature and outside (fresh) air position will be selected automatically.

### Auto defogging system (Only for automatic climate control system, if equipped)



Auto defogging reduces the possibility of fogging up the inside of the windshield by automatically sensing the moisture of inside the windshield.

The auto defogging system operates when the climate control system is on.

### \* NOTICE

The auto defogging system may not operate normally, when the outside temperature is below  $-10^{\circ}\text{C}$ .



This indicator illuminates when the auto defogging system senses the moisture of inside the windshield and operates.

If more moisture is in the vehicle, higher steps operate as follow.

- Step 1 : Operating the air conditioning
- Step 2 : Outside air position
- Step 3 : Blowing air flow toward the windshield
- Step 4 : Increasing air flow toward the windshield

If your vehicle is equipped with the auto defogging system, it is automatically activated when the conditions are met. However, if you would like to cancel the auto defogging system, press the front defroster button 4 times within 2 seconds while pressing the AUTO button. The indicator of front defroster button will blink 3 times to notify you that the system is cancelled. To use the auto defogging system again, follow the procedures mentioned above.

If the battery has been disconnected or discharged, it resets to the auto defogging status.

### \* NOTICE

If the A/C off is manually selected while the auto defogging system is on, the auto defogging indicator will blink 3 times to give notice that the A/C off can not be selected.

### ⚠ CAUTION

***Do not remove the sensor cover located on the upper end of the driver side windshield glass. Damage to the system parts could occur and may not be covered by your vehicle warranty.***

تلفن شبانه روزی: ۰۲۱-۸۸۸۶۲۰۸۵

FarmaSOS.com

## CLEAN AIR (IF EQUIPPED)



When the ignition switch is in the ON position, the clean air function turns on automatically.

Also, the clean air function turns off automatically, when the ignition switch turns to the OFF position.

## STORAGE COMPARTMENT

### ⚠ CAUTION

- *To avoid possible theft, do not leave valuables in the storage compartment.*
- *Always keep the storage compartment covers closed while driving. Do not attempt to place so many items in the storage compartment that the storage compartment cover can not close securely.*

### ⚠ WARNING - Flammable materials

Do not store cigarette lighters, propane cylinders, or other flammable/explosive materials in the vehicle. These items may catch fire and/or explode if the vehicle is exposed to hot temperatures for extended periods.

### Center console storage

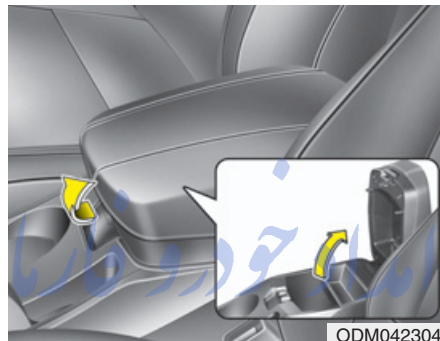

To open the center console storage, push the lever and then lift up the cover.

### Glove box

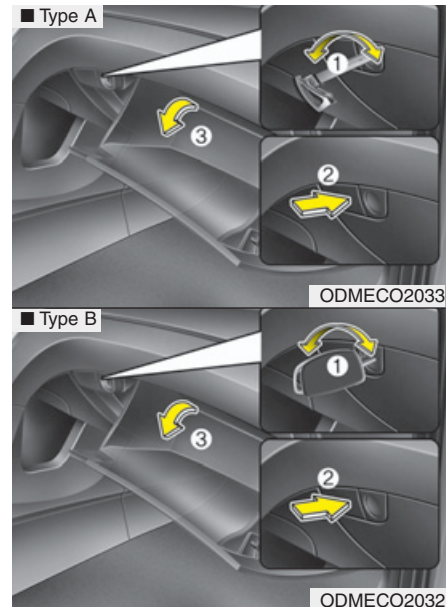

The glove box can be locked and unlocked with a key. (1)

To open the glove box, push the button (2) and the glove box will automatically open (3). Close the glove box after use.

**⚠ WARNING**

To reduce the risk of injury in an accident or sudden stop, always keep the glove box door closed while driving.

**⚠ CAUTION**

Do not keep food in the glove box for a long time.

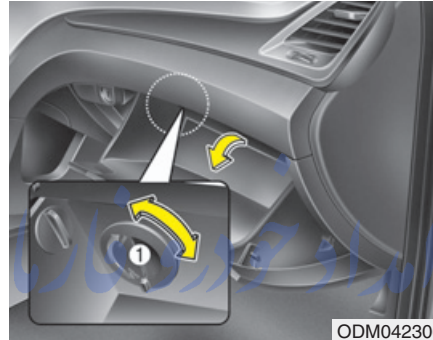
**Cool box (if equipped)**

You can keep beverage cans or other items cool in the glove box.

1. Turn on the air conditioning.
2. Slide the open/close lever (1) of the vent installed in the glove box to the open position.
3. When the cool box is not used, slide the lever (1) to the closed position.

**\* NOTICE**

If some items in the cool box block the vent, the cooling effectiveness of the cool box is reduced.

**⚠ WARNING**

Do not put perishable food in the cool box because it may not maintain the necessary consistent temperature to keep the food fresh.

### Multi box (if equipped)

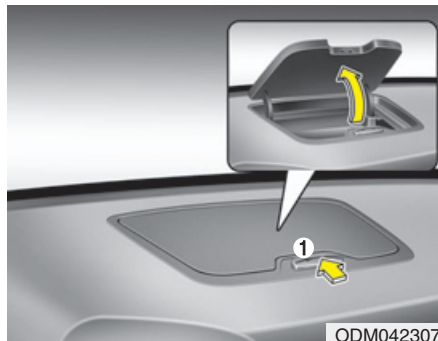

To open the cover, push the lever (1) and the multi box will open automatically.

It can be used for storing small items.

#### CAUTION

***Do not drive with the multi box open.***

### Sunglass holder

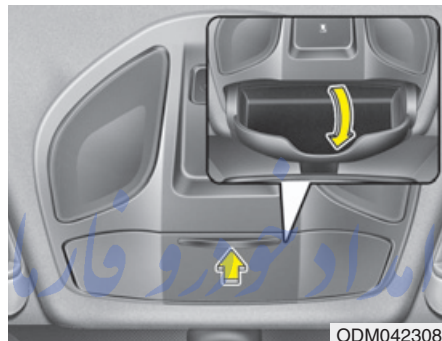

To open the sunglasses holder, press the cover and the holder will slowly open. Place your sunglasses in the compartment door with the lenses facing out. Push to close.

#### WARNING

- Do not keep objects except sunglasses inside the sunglasses holder. Such objects can be thrown from the holder in the event of a sudden stop or an accident, possibly injuring the passengers in the vehicle.
- Do not open the sunglasses holder while the vehicle is moving. The rear view mirror of the vehicle can be blocked by an open sunglasses holder.
- Do not put the glasses forcibly into a sunglasses holder to prevent breakage or deformation of glasses. It may cause personal injury if you try to open it forcibly when the glasses are jammed in holder.

## Luggage tray

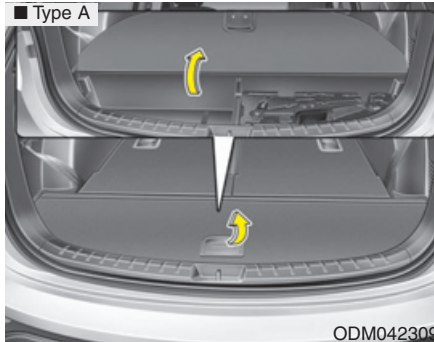

You can place a first aid kit, a reflector triangle, tools, etc. in the box for easy access.

### Type A

- Grasp the handle on the top of the cover and lift it.

### Type B

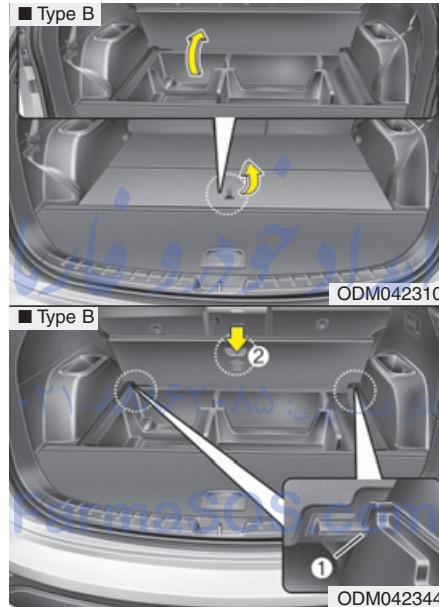

1. Grasp the handle on the top of the cover and lift it.
2. Push the cover toward the front of the vehicle and fit into the hole of the luggage side (1).

3. After using the tray, pull up the cover (2) and close the tray.

## INTERIOR FEATURES

### Cigarette lighter (if equipped)

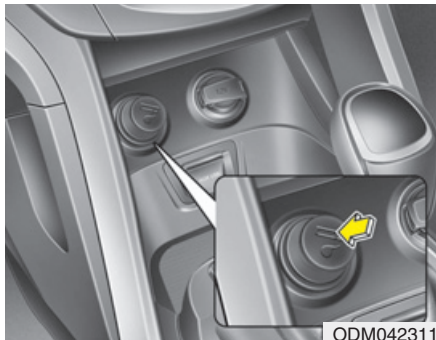

For the cigarette lighter to work, the ignition switch must be in the ACC position or the ON position.

To use the cigarette lighter:

1. Open the cover by pressing the switch.
2. Push the lighter all the way into the socket.

When the element has heated, the lighter will pop out to the "ready" position.

We recommend that you use parts for replacement from an authorized HYUNDAI dealer.

#### **⚠ WARNING**

- Holding the lighter in after it is heated will cause it to over-heat.
- If the lighter does not pop out within 30 seconds, remove it to prevent overheating.
- Do not insert foreign objects into the socket of the cigarette lighter. It may damage the cigarette lighter.

#### **⚠ CAUTION**

*The use of plug-in accessories (shavers, hand-held vacuums, and coffee pots, for example) may damage the socket or cause electrical failure.*

### Ashtray (if equipped)

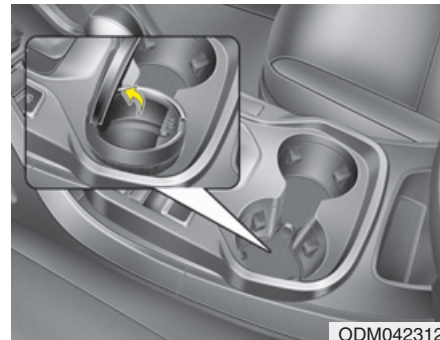

To use the ashtray, open the cover.

To clean or empty the ashtray, pull it out.

#### **⚠ WARNING - Ashtray use**

- Do not use the vehicle's ashtray as a waste receptacle.
- Putting lit cigarettes or matches in an ashtray with other combustible materials may cause a fire.

## Cup holder

Cups or small beverage cans may be placed in the cup holders.

### **⚠ WARNING - Hot liquids**

- Do not place uncovered cups of hot liquid in the cup holder while the vehicle is in motion. If the hot liquid spills, you may burn yourself. Such a burn to the driver could lead to loss of control of the vehicle.
- To reduce the risk of personal injury in the event of sudden stop or collision, do not place uncovered or unsecured bottles, glasses, cans, etc., in the cup holder while the vehicle is in motion.

### **⚠ WARNING**

Keep cans and bottles out of direct sunlight. Placing them in a hot vehicle can cause them to explode.

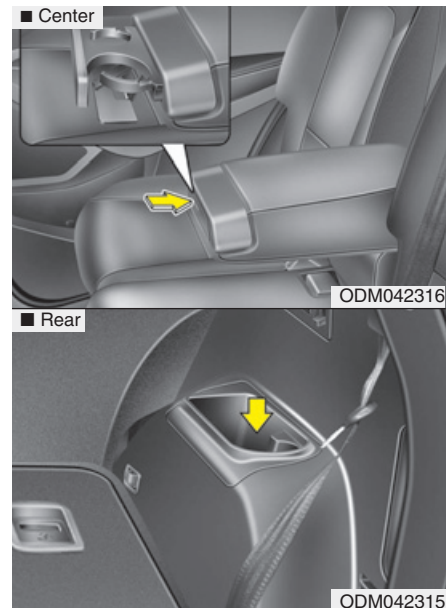
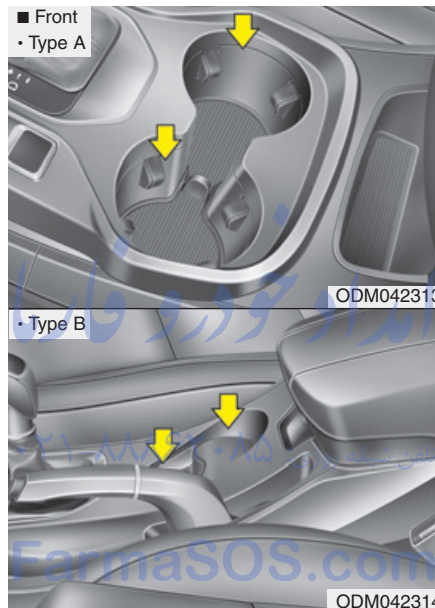

To use the center cup holder, pull down the armrest and press the open button.



### Bottle holder

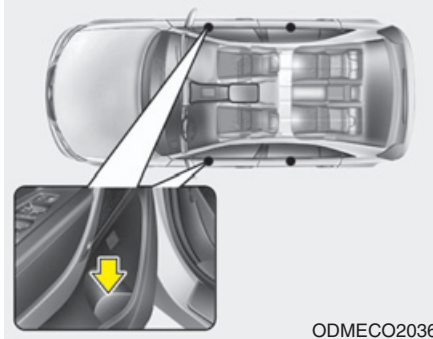

Bottles may be placed in the holder.

### \* NOTICE

Only bottles should be placed in the holder as it is written in the vehicle “BOTTLE ONLY”.

### Sunvisor



Use the sunvisor to shield direct light through the front or side windows.

To use the sunvisor, pull it downward.

To use the sunvisor for the side window, pull it downward, unsnap it from the bracket (1) and swing it to the side (2).

To use the vanity mirror, pull down the visor and slide the mirror cover (3).

### **⚠ WARNING**

For your safety, do not block your view when using the sunvisor.

## Power outlet

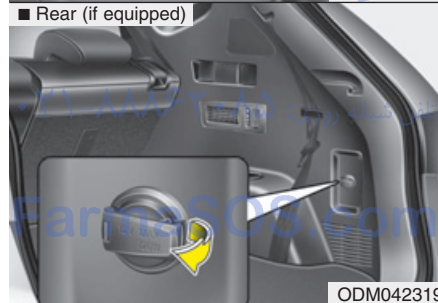
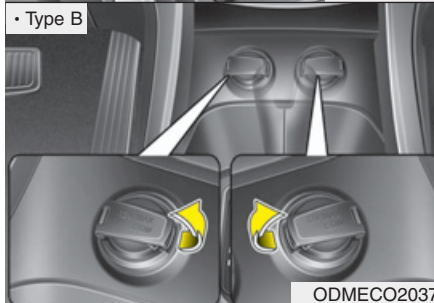
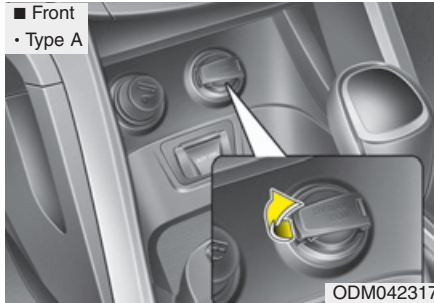

The power outlet is designed to provide power for mobile telephones or other devices designed to operate with vehicle electrical systems. The devices should draw less than 10 amps with the engine running.

### CAUTION

- *Use power outlet only when the engine is running and remove the accessory plug after use. Using the accessory plug for prolonged periods of time with the engine off could cause the battery to discharge.*
- *Only use 12V electric accessories which are less than 10A in electric capacity.*
- *Adjust the air-conditioner or heater to the lowest operating level when using the power outlet.*
- *Close the cover when not in use.*
- *Some electronic devices can cause electronic interference when plugged into a vehicle's power outlet. These devices may cause excessive audio static and malfunctions in other electronic systems or devices used in your vehicle.*

## **⚠ WARNING**

**Do not put a finger or a foreign element (pin, etc.) into a power outlet and do not touch with a wet hand. You may get electrocuted or fire may occur.**

## **AC inverter (if equipped)**

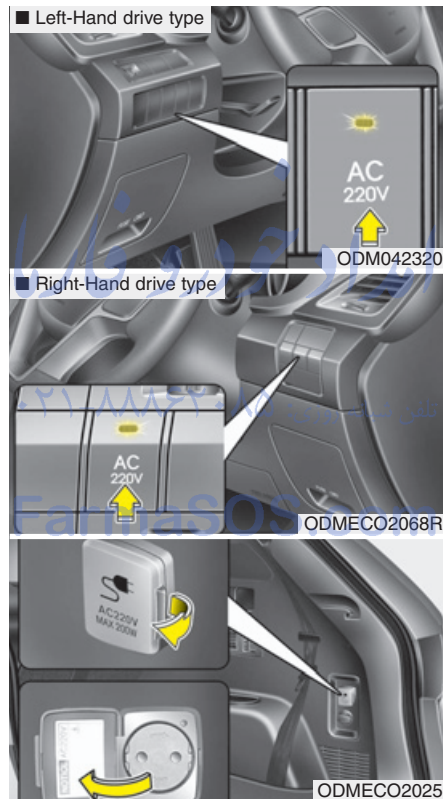

The AC inverter supplies 220V/200W electric power to operate electric accessories or equipments.

If you wish to use the AC inverter, press the AC inverter button while the engine is running. The light on the AC inverter button will illuminate.

If you press the AC inverter button again, the AC inverter will be deactivated and the light on the AC inverter button will turn off.

## **\* NOTICE**

**When turning on the AC inverter, the indicator on the AC inverter button illuminates late while the system conducts a self-check.**



ODMECO2070

### \* NOTICE

- Rated voltage : AC 220V
- Maximum electric power : 200W
- In order to avoid an electrical system failure, electric shock, etc., be sure to read owner's manual before use.
- Be sure to close the cover except the time of use.

### ⚠ WARNING

To reduce a risk of serious or fatal injuries:

- Do not use a heated electric device such as a coffeepot, toaster, heater, iron, etc.
- Do not insert foreign objects into the outlet and do not touch the outlet as you may get shocked.
- Do not let children touch the AC inverter.

تلفن شبانه روزی: ۰۲۱-۸۸۸۶۲۰۸۵

FarmaSOS.com

### ⚠ CAUTION

- To prevent the battery from being discharged, do not use the AC inverter while the engine is not running.
- When not using the AC inverter, make sure to turn off the AC inverter (the indicator on the button does not illuminate) and close the AC inverter cover.
- After using an electric accessory or equipment, pull the plug out. Leaving the accessory or equipment plugged in for a long time may cause battery discharge.
- Do not use an electric accessory or equipment the power consumption of which is greater than 200W(220V).

(Continued)

*(Continued)*

- *Some electric accessories or equipments can cause electronic interference. It may cause excessive audio noise and malfunctions in other electric systems or devices in the vehicle.*
- *Do not use broken electric accessories or equipments, which may damage the AC inverter and electrical systems of the vehicle.*
- *Do not use two or more electric accessories or equipments at the same time. It may cause damage to the electrical systems of the vehicle.*
- *When the input voltage is under 11V, the outlet LED will blink and the AC inverter will turn off automatically. If the input voltage goes up to normal, the AC inverter will turn on again.*

### Aux, USB and iPod (if equipped)

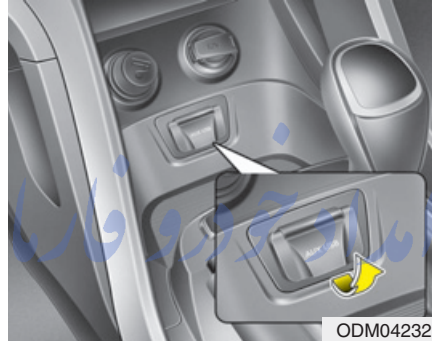

If your vehicle has an aux and/or USB (universal serial bus) port, you can use an aux port to connect audio devices and an USB port to plug in an USB and also in an iPod.

### \* NOTICE

When using a portable audio device connected to the power outlet, noise may occur during playback. If this happens, use the power source of the portable audio device.

\* iPod® is a trademark of Apple Inc.

## Clothes hanger

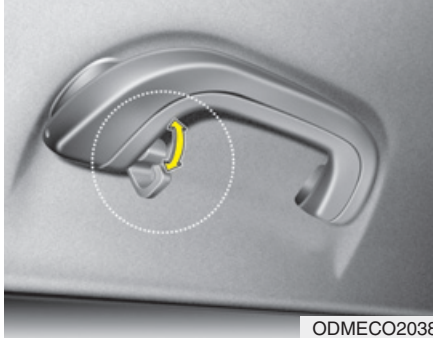

### ⚠ CAUTION

- *Do not hang heavy clothes, since those may damage the hook.*
- *Be careful when opening and closing the doors. Clothes, etc. may get caught between the door gap.*

### ⚠ WARNING

Do not hang other objects except clothes. In an accident it may cause vehicle damage or personal injury.

## Floor mat anchor(s) (if equipped)

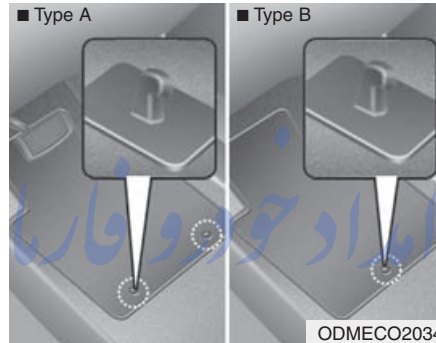

When using a floor mat on the front floor carpet, make sure it attaches to the floor mat anchor(s) in your vehicle. This keeps the floor mat from sliding forward.

### ⚠ WARNING

The following must be observed when installing ANY floor mat to the vehicle.

- Ensure that the floor mats are securely attached to the vehicle's floor mat anchor(s) before driving the vehicle.
- Do not use ANY floor mat that cannot be firmly attached to the vehicle's floor mat anchors.
- Do not stack floor mats on top of one another (e.g. all-weather rubber mat on top of a carpeted floor mat). Only a single floor mat should be installed in each position.

**IMPORTANT** – Your vehicle was manufactured with driver's side floor mat anchors that are designed to securely hold the floor mat in place. To avoid any interference with pedal operation, we recommend that the HYUNDAI floor mat designed for use in your vehicle be installed.

### Luggage net (holder) (if equipped)

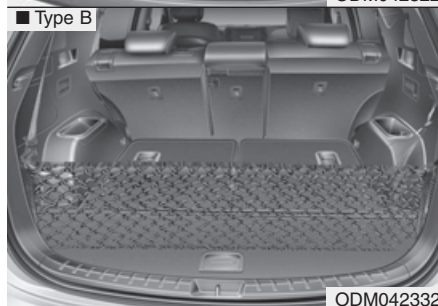

To keep items from shifting in the cargo area, you can use the four holders located in the cargo area to attach the luggage net.

If necessary, we recommend that you contact your authorized HYUNDAI dealer to obtain a luggage net.

### \* NOTICE

Vehicles equipped with a luggage rail system may use the shackles to hook the luggage net.

### ⚠ CAUTION

*To prevent damage to the goods or the vehicle, care should be taken when carrying fragile or bulky objects in the luggage compartment.*

### ⚠ WARNING

**To avoid eye injury, DO NOT overstretch the luggage net. ALWAYS keep your face and body out of the luggage net's recoil path. DO NOT use the luggage net when the strap has visible signs of wear or damage.**

### Cargo security screen (if equipped)



Use the cargo security screen to hide items stored in the cargo area.

**To use the cargo security screen**

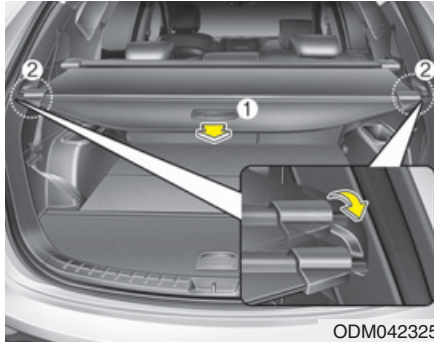

1. Pull the cargo security screen towards the rear of the vehicle by the handle (1).
2. Insert the guide pin into the guide (2).

**\* NOTICE**

Pull out the cargo security screen with the handle in the center to prevent the guide pin from falling out of the guide.

When the cargo security screen is not in use:

1. Pull the cargo security screen backward and up to release it from the guides.
2. The cargo security screen will automatically slide back in.

**\* NOTICE**

The cargo security screen may not automatically slide back in if the cargo security screen is not fully pulled out. Fully pull it out and then let go.

تلفن شبانه روزی: ۰۲۱-۸۸۸۶۲۰۸۵

FarmaSOS.com

**To remove the cargo security screen**

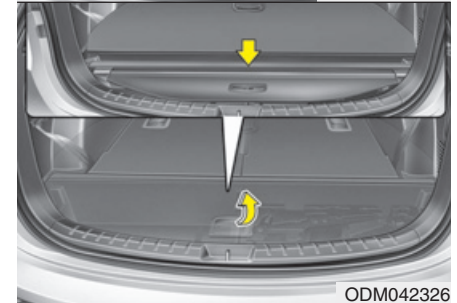
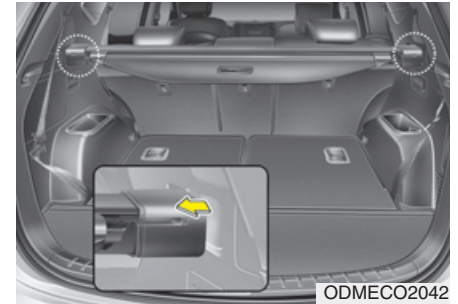

1. Push in the guide pin.
2. While pushing the guide pin, pull out the cargo security screen.
3. Open the luggage tray and keep the cargo security screen in the tray.



### To remove the cargo security screen from the luggage tray

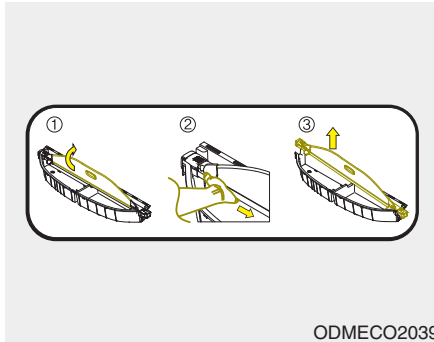

1. Pull up the screen board.
2. Push in the guide pin.
3. While pushing the guide pin, pull out the cargo security screen.

### **⚠ WARNING**

- Do not place objects on the cargo security screen. Such objects may be thrown about inside the vehicle and possibly injure vehicle occupants during an accident or when braking.
- Never allow anyone to ride in the luggage compartment. It is designed for luggage only.
- Maintain the balance of the vehicle and locate the weight as forward as possible.

### **⚠ CAUTION**

*Since the cargo security screen may be damaged or malformed, do not put luggage on it when it is used.*

### Side curtain (if equipped)

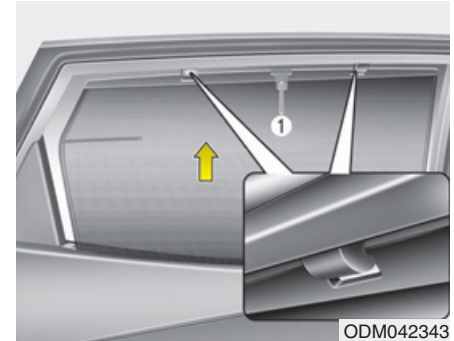

To use the side curtain:

1. Lift the curtain by the hook (1).
2. Hang the curtain on both sides of the hook.

## EXTERIOR FEATURES

### Roof rack (if equipped)

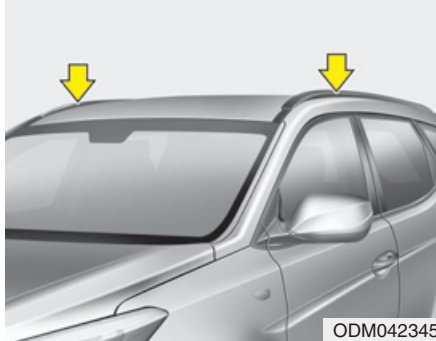

ODM042345

If the vehicle has a roof rack, you can load cargo on top of your vehicle.

### \* NOTICE

If the vehicle is equipped with a sunroof, be sure not to position cargo onto the roof rack in such a way that it could interfere with sunroof operation.

### ⚠ CAUTION

- When carrying cargo on the roof rack, take the necessary precautions to make sure the cargo does not damage the roof of the vehicle.
- When carrying large objects on the roof rack, make sure they do not exceed the overall roof length or width.

### ⚠ WARNING

- The following specification is the maximum weight that can be loaded onto the roof rack. Distribute the load as evenly as possible onto the roof rack and secure the load firmly.

ROOF RACK	100 kg (220 lbs.) EVENLY DISTRIBUTED
-----------	---

Loading cargo or luggage in excess of the specified weight limit on the roof rack may damage your vehicle.

(Continued)

(Continued)

- The vehicle center of gravity will be higher when items are loaded onto the roof rack. Avoid sudden starts, braking, sharp turns, abrupt maneuvers or high speeds that may result in loss of vehicle control or rollover resulting in an accident.
- Always drive slowly and turn corners carefully when carrying items on the roof rack. Severe wind updrafts, caused by passing vehicles or natural causes, can cause sudden upward pressure on items loaded on the roof rack. This is especially true when carrying large, flat items such as wood panels or mattresses. This could cause the items to fall off the roof rack and cause damage to your vehicle or others around you.
- To prevent damage or loss of cargo while driving, check frequently before or while driving to make sure the items on the roof rack are securely fastened.

## AUDIO SYSTEM

### \* NOTICE

- If you install an aftermarket HID head lamp, your vehicle's audio and electronic device may malfunction.
- Prevent chemicals such as perfume, cosmetic oil, sun cream, hand cleaner and air freshener from contacting the interior parts because they may cause damage or discoloration.

### Antenna

#### Roof antenna

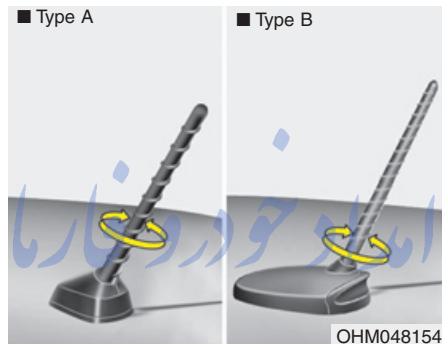

Your car uses a roof antenna to receive both AM and FM broadcast signals. This antenna is a removable type. To remove the antenna, turn it counterclockwise. To install the antenna, turn it clockwise.

### ⚠ CAUTION

- Before entering a place with a low height clearance or a car wash, remove surely the antenna by rotating it counterclockwise. If not, the antenna may be damaged.
- When reinstalling your antenna, it is important that it is fully tightened and adjusted to the upright position to ensure proper reception. The antenna can be folded or removed when parking the vehicle or when loading cargo on the roof rack.
- When cargo is loaded on the roof rack, do not place the cargo near the antenna pole to ensure proper reception.

## Audio remote control (if equipped)



ODM042327

\* The actual feature in the vehicle may differ from the illustration.

The steering wheel audio remote control button is installed to promote safe driving.

### CAUTION

**Do not operate audio remote control buttons simultaneously.**

### **MODE (1)**

Press the button to select Radio, CD (compact disc), USB or AUX (if equipped).

### **SEEK (^ / v) (2)**

If the SEEK button is pressed for 0.8 second or more, it will work as follows in each mode.

#### **RADIO mode**

It will function as the AUTO SEEK select button.

#### **CDP mode**

It will function as the FF/REW button.

If the SEEK button is pressed for less than 0.8 second, it will work as follows in each mode.

#### **RADIO mode**

It will function as the PRESET STATION select buttons.

#### **CDP mode**

It will function as the TRACK UP/DOWN button.

### **VOL (+ / -) (3)**

- Press the up button (+) to increase volume.
- Press the down button (-) to decrease volume.

### **MUTE (4)**

- Press the MUTE button to cancel the sound.
- Press the MUTE button again to activate the sound.

Detailed information for audio control buttons is described in the following pages in this section.

تلفن شبانه روزی: ۰۲۱-۸۸۸۶۲۰۸۵

FarmaSOS.com

### How vehicle audio works

#### FM reception

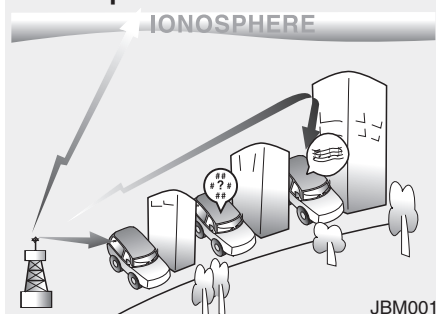

AM and FM radio signals are broadcast from transmitter towers located around your city. They are intercepted by the radio antenna on your vehicle. This signal is then received by the radio and sent to your vehicle speakers.

When a strong radio signal has reached your vehicle, the precise engineering of your audio system ensures the best possible quality reproduction. However, in some cases the signal coming to your vehicle may not be strong and clear.

This can be due to factors, such as the distance from the radio station, closeness of other strong radio stations or the presence of buildings, bridges or other large obstructions in the area.

امداد خودرو فارما

تلفن شبانه روزی: ۰۲۱-۸۸۸۶۲۰۸۵

FarmaSOS.com

#### AM (MW, LW) reception

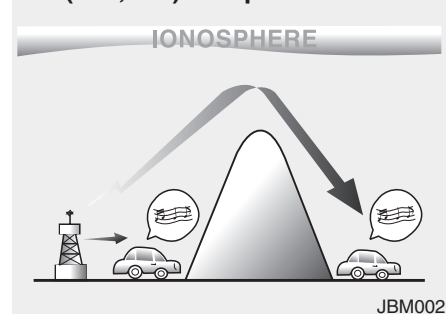

AM broadcasts can be received at greater distances than FM broadcasts. This is because AM radio waves are transmitted at low frequencies. These long, low frequency radio waves can follow the curvature of the earth rather than travelling straight out into the atmosphere. In addition, they curve around obstructions so that they can provide better signal coverage.

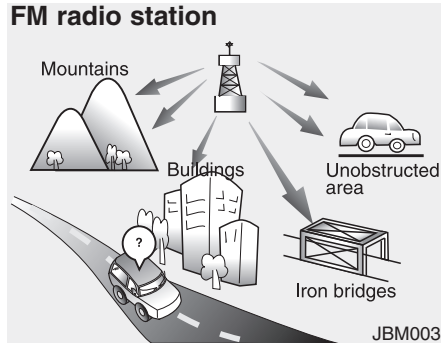

FM broadcasts are transmitted at high frequencies and do not bend to follow the earth's surface. Because of this, FM broadcasts generally begin to fade at short distances from the station. Also, FM signals are easily affected by buildings, mountains, or other obstructions. These can result in certain listening conditions which might lead you to believe a problem exists with your radio. The following conditions are normal and do not indicate radio trouble:

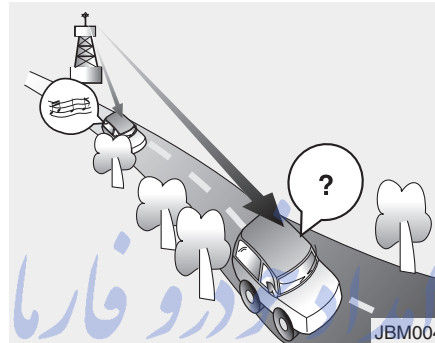

- **Fading** - As your vehicle moves away from the radio station, the signal will weaken and sound will begin to fade. When this occurs, we suggest that you select another stronger station.
- **Flutter/Static** - Weak FM signals or large obstructions between the transmitter and your radio can disturb the signal causing static or fluttering noises to occur. Reducing the treble level may lessen this effect until the disturbance clears.

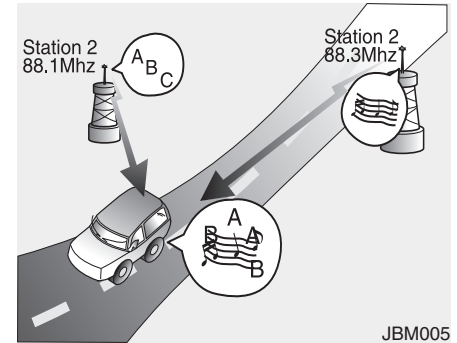

- **Station Swapping** - As a FM signal weakens, another more powerful signal near the same frequency may begin to play. This is because your radio is designed to lock onto the clearest signal. If this occurs, select another station with a stronger signal.
- **Multi-Path Cancellation** - Radio signals being received from several directions can cause distortion or fluttering. This can be caused by a direct and reflected signal from the same station, or by signals from two stations with close frequencies. If this occurs, select another station until the condition has passed.

### *Using a cellular phone or a two-way radio*

When a cellular phone is used inside the vehicle, noise may be produced from the audio system. This does not mean that something is wrong with the audio equipment. In such a case, use the cellular phone at a place as far as possible from the audio equipment.

#### **⚠ CAUTION**

***When using a communication system such as a cellular phone or a radio set inside the vehicle, a separate external antenna must be fitted. When a cellular phone or a radio set is used with an internal antenna alone, it may interfere with the vehicle's electrical system and adversely affect safe operation of the vehicle.***

#### **⚠ WARNING**

**Do not use a cellular phone while driving. Stop at a safe location to use a cellular phone.**

امداد خودرو فارما

تلفن شبانه روزی: ۰۲۱-۸۸۸۶۲۰۸۵

FarmaSOS.com

### **Caring for disc**

- If the temperature inside the car is too high, open the car windows to ventilate before using the system.
- It is illegal to copy and use MP3/WMA files without permission. Use CDs that are created only by lawful means.
- Do not apply volatile agents, such as benzene and thinner, normal cleaners and magnetic sprays made for analogue disc onto CDs.
- To prevent the disc surface from getting damaged, hold CDs by the edges or the center hole only.
- Clean the disc surface with a piece of soft cloth before playback (wipe it from the center to the outside edge).
- Do not damage the disc surface or attach pieces of sticky tape or paper.
- Make certain only CDs are inserted into the CD player (Do not insert more than one CD at a time).
- Keep CDs in their cases after use to protect them from scratches or dirt.

- Depending on the type of CD-R/CD-RW CDs, certain CDs may not operate normally according to manufacturing companies or making and recording methods. In such circumstances, continued use may cause malfunctions to your audio system.

**\* NOTICE - Playing an Incompatible Copy Protected Audio CD**

Some copy protected CDs, which do not comply with international audio CD standards (Red Book), may not play on your car audio. Please note that inability to properly play a copy protected CD may indicate that the CD is defective, not the CD player.

**\* NOTICE**

**Order of playing files (folders) :**

1. Song playing order : ① to ⑭ sequentially.
  2. Folder playing order :
- \* If no song file is contained in the folder, that folder is not displayed.

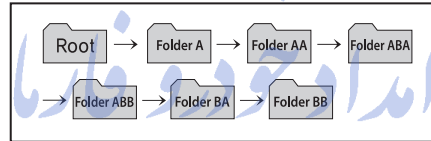

تلفن شبانه روزی: ۰۲۱-۸۸۸۶۲۰۸۵

FarmaSOS.com

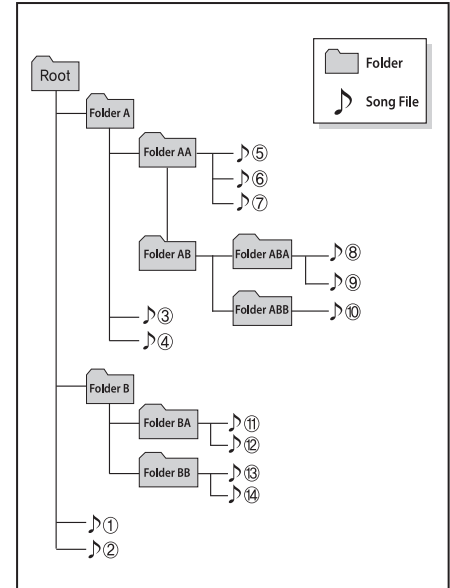



**⚠ WARNING**

- Do not stare at the screen while driving. Staring at the screen for prolonged periods of time could lead to traffic accidents.
- Do not disassemble, assemble, or modify the audio system. Such acts could result in accidents, fire, or electric shock.
- Using the phone while driving may lead to a lack of attention of traffic conditions and increase the likelihood of accidents. Use the phone feature after parking the vehicle.
- Heed caution not to spill water or introduce foreign objects into the device. Such acts could lead to smoke, fire, or product malfunction.

(Continued)

(Continued)

- Please refrain from use if the screen is blank or no sound can be heard as these signs may indicate product malfunction. Continued use in such conditions could lead to accidents (fires, electric shock) or product malfunctions.
- Do not touch the antenna during thunder or lightening as such acts may lead to lightning induced electric shock.
- Do not stop or park in parking-restricted areas to operate the product. Such acts could lead to traffic accidents.
- Use the system with the vehicle ignition turned on. Prolonged use with the ignition turned off could result in battery discharge.

**⚠ CAUTION**

- *Operating the device while driving could lead to accidents due to a lack of attention to external surroundings. First park the vehicle before operating the device.*
- *Adjust the volume to levels that allow the driver to hear sounds from outside of the vehicle. Driving in a state where external sounds cannot be heard may lead to accidents.*
- *Pay attention to the volume setting when turning the device on. A sudden output of extreme volume upon turning the device on could lead to hearing impairment. (Adjust the volume to a suitable levels before turning off the device.)*

(Continued)

**(Continued)**

- ***If you want to change the position of device installation, please inquire with your place of purchase or service maintenance center. Technical expertise is required to install or disassemble the device.***
- ***Turn on the car ignition before using this device. Do not operate the audio system for long periods of time with the ignition turned off as such operations may lead to battery discharge.***
- ***Do not subject the device to severe shock or impact. Direct pressure onto the front side of the monitor may cause damage to the LCD or touch screen.***

**(Continued)**

**(Continued)**

- ***When cleaning the device, make sure to turn off the device and use a dry and smooth cloth. Never use tough materials, chemical cloths, or solvents (alcohol, benzene, thinners, etc.) as such materials may damage the device panel or cause color/quality deterioration***
- ***Do not place beverages close to the audio system. Spilling beverages may lead to system malfunction.***
- ***In case of product malfunction, please contact your place of purchase or After Service center.***
- ***Placing the audio system within an electromagnetic environment may result in noise interference.***

**\* NOTICE - USING THE USB DEVICE**

- To use an external USB device, make sure the device is not connected when starting up the vehicle. Connect the device after starting up.
- If you start the engine when the USB device is connected, it may damage the USB device. (USB flashdrives are very sensitive to electric shock.)
- If the engine is started up or turned off while the external USB device is connected, the external USB device may not work.
- The System may not play inauthentic MP3 or WMA files.
  - 1) It can only play MP3 files with the compression rate between 8Kbps ~ 320Kbps.
  - 2) It can only play WMA music files with the compression rate between 8Kbps ~ 320Kbps.
- Take precautions for static electricity when connecting or disconnecting the external USB device.
- An encrypted MP3 PLAYER is not recognizable.

(Continued)

(Continued)

- Depending on the condition of the external USB device, the connected external USB device can be unrecognizable.
- When the formatted byte/sector setting of External USB device is not either 512BYTE or 2048BYTE, then the device will not be recognized.
- Use only a USB device formatted to FAT 12/16/32.
- USB devices without USB I/F authentication may not be recognizable.
- Make sure the USB connection terminal does not come in contact with the human body or other objects.
- If you repeatedly connect or disconnect the USB device in a short period of time, it may break the device.
- You may hear a strange noise when connecting or disconnecting a USB device.

(Continued)

(Continued)

- If you disconnect the external USB device during playback in USB mode, the external USB device can be damaged or may malfunction. Therefore, disconnect the external USB device when the audio is turned off or in another mode. (e.g, Radio, CD)
- Depending on the type and capacity of the external USB device or the type of the files stored in the device, there is a difference in the time taken for recognition of the device.
- Do not use the USB device for purposes other than playing music files.
- Playing videos through the USB is not supported.
- Use of USB accessories such as rechargers or heaters using USB I/F may lower performance or cause trouble.

(Continued)

(Continued)

- If you use devices such as a USB hub purchased separately, the vehicle's audio system may not recognize the USB device. In that case, connect the USB device directly to the multimedia terminal of the vehicle.
- If the USB device is divided by logical drives, only the music files on the highest-priority drive are recognized by car audio.
- Devices such as MP3 Player/ Cellular phone/Digital camera can be unrecognizable by standard USB I/F can be unrecognizable.
- Charging through the USB may not be supported in some mobile devices.
- USB HDD or USB types liable to connection failures due to vehicle vibrations are not supported. (i-stick type)
- Some non-standard USB devices (METAL COVER TYPE USB) can be unrecognizable.

(Continued)

(Continued)

- Some USB flash memory readers (such as CF, SD, micro SD, etc.) or external-HDD type devices can be unrecognizable.
- Music files protected by DRM (DIGITAL RIGHTS MANAGEMENT) are not recognizable.
- The data in the USB memory may be lost while using this audio. Always back up important data on a personal storage device.
- Please avoid using USB memory products which can be used as key chains or cellular phone accessories as they could cause damage to the USB jack. Please make certain only to use plug type connector products.



**\* NOTICE - USING THE iPod®  
DEVICE**

- Some iPod models may not support communication protocol and files may not properly play.

Supported iPod models:

- iPod Mini
- iPod 4th (Photo) ~ 6th (Classic) generation
- iPod Nano 1st~4th generation
- iPod Touch 1st~2nd generation
- The order of search or playback of songs in the iPod can be different from the order searched in the audio system.
- If the iPod disabled due to its own malfunction, reset the iPod. (Reset: Refer to iPod manual)
- An iPod may not operate normally on low battery.

(Continued)

(Continued)

- Some iPod devices, such as the iPhone, can be connected through the *Bluetooth®* Wireless Technology interface. The device must have audio *Bluetooth®* Wireless Technology capability (such as for stereo headphone *Bluetooth®* Wireless Technology). The device can play, but it will not be controlled by the audio system.
- To use iPod features within the audio, use the cable provided upon purchasing an iPod device.
- Skipping or improper operation may occur depending on the characteristics of your iPod/Phone device.
- If your iPhone is connected to both the *Bluetooth®* Wireless Technology and USB, the sound may not be properly played. In your iPhone, select the Dock connector or *Bluetooth®* Wireless Technology to change the sound output (source).

(Continued)

(Continued)

- When connecting iPod with the iPod Power Cable, insert the connector to the multimedia socket completely. If not inserted completely, communications between iPod and audio may be interrupted.
- When adjusting the sound effects of the iPod and the audio system, the sound effects of both devices will overlap and might reduce or distort the quality of the sound.
- Deactivate (turn off) the equalizer function of an iPod when adjusting the audio system's volume, and turn off the equalizer of the audio system when using the equalizer of an iPod.
- When not using iPod with car audio, detach the iPod cable from iPod. Otherwise, iPod may remain in accessory mode, and may not work properly.

■ CD Player (for RDS model)  
AM104DMEE, AM114DMEE



FarmaSOS.com

\* No  Bluetooth logo will be shown if the *Bluetooth*<sup>®</sup> Wireless Technology feature is not supported.

- CD Player : AM100DMMG, AM110DMMG, AM111DMMG, AM101DMGG, AM110DMEE, AM111DMEE, AM112DMEE, AM113DMEE\*, AM110DMGL, AM111DMGL\*\*, AM100DMMN, AM110DMMN



FarmaSOS.com

\* : For Singapore

\*\* : For Columbia

✳ No  Bluetooth logo will be shown if the *Bluetooth®* Wireless Technology feature is not supported.

## SYSTEM CONTROLLERS AND FUNCTIONS

※ Display and settings may differ depending on the selected audio.

### Audio Head Unit (for RDS model)



1. **EJECT**

- Ejects the disc.

2. **RADIO**

- Changes to FM/AM mode.
- Each time the key is pressed, the mode is changed in order of FM1 → FM2 → FMA → AM → AMA.
- ※ In Setup>Display, the radio pop up screen will be displayed when [Mode Pop up] is turned **On**.  
When the pop up screen is displayed, use the **TUNE** knob or keys **1** ~ **6** to select the desired mode.

3. **MEDIA**

- Changes to CD, USB(iPod), AUX, My Music, BT Audio mode.
- Each time the key is pressed, the mode is changed in order of CD, USB(iPod), AUX, My Music, BT Audio.
- ※ In Setup>Display, the media pop up screen will be displayed when [Mode Pop up] is turned **On**.  
When the pop up screen is displayed, use the **TUNE** knob or keys **1** ~ **6** to select the desired mode.

4. **PHONE** (for Bluetooth® Wireless Technology equipped model)

- Operates Phone Screen
- ※ When a phone is not connected, the connection screen is displayed.

5. **PWR/VOL knob**

- **Power Knob**: Turns power On/Off by pressing the knob
- **Volume Knob**: Sets volume by turning the knob left/right





### 6. **SEEK TRACK**

- Radio Mode : Automatically searches for broadcast frequencies.
- CD, USB, iPod, My Music modes
  - Shortly press the key (under 0.8 seconds): Moves to next or previous song (file)
  - Press and hold the key (over 0.8 seconds): Rewinds or fast-forwards the current song.

### 7. **PTY FOLDER**

- FM : RDS Program Type Search
- CD MP3, USB mode : Folder Search

### 8. **1 ~ 6** (Preset)

- Radio Mode: Saves frequencies (channels) or receives saved frequencies (channels)
- CD, USB, iPod, My Music mode
  - **1 RPT** : Repeat
  - **2 RDM** : Random
- In the Radio, Media, Setup, and Menu pop up screen, the number menu is selected.

### 9. **☾**

- Each time the button is shortly pressed (under 0.8 seconds), sets screen Off → Screen On → Screen Off
- \* Audio operation is maintained and only the screen will be turned Off. In the screen Off state, press any key to turn the screen On again.

### 10. **TA SCAN**

- Radio Mode
  - Press and hold the key (over 0.8 seconds): Previews each broadcast for 5 seconds each
- CD, USB, My Music mode
  - Press and hold the key (over 0.8 seconds): Previews each song (file) for 10 seconds each
- \* Press the key again to continue listening to the current song (file).

### 11. **SETUP CLOCK**

- Shortly press the key (under 0.8 seconds) : Moves to the Display, Sound, Clock, Phone, System setting modes
- Press and hold the key (over 0.8 seconds) : Move to the Time setting screen

### 12. **MEMU**

Displays menus for the current mode.

13.  TUNE knob

- Radio mode : Changes frequency by turning the knob left/right
- CD, USB, iPod, My Music mode: Searches .songs (files) by turning the knob left/right
- \* When the desired song is displayed, press the knob to play the song.
- Moves focus in all selection menus and selects menus



14. DISC-IN LED

- LED that indicates whether a disc is inserted



15.  FM

- Changes to FM mode.
- Each time the key is pressed, the mode changed in order of FM1 → FM2 → FMA.

16.  AM

- Changes to AM mode.
- Each time the key is pressed, the mode changed in order of AM → AMA.

## Audio Head Unit



### 1. **EJECT** (EJECT)

- Ejects the disc.

### 2. **RADIO**

- Changes to FM/AM mode.
- Each time the key is pressed, the mode is changed in order of FM1 → FM2 → AM.
- ※ In Setup>Display, the radio pop up screen will be displayed when [Mode Pop up] is turned **On**.  
When the pop up screen is displayed, use the **TUNE** knob or keys **1** ~ **6** to select the desired mode.

### 3. **MEDIA**

- Changes to CD, USB(iPod), AUX, My Music, BT Audio mode.
- Each time the key is pressed, the mode is changed in order of CD, USB(iPod), AUX, My Music, BT Audio mode.
- ※ In Setup>Display, the media pop up screen will be displayed when [Mode Pop up] is turned **On**.  
When the pop up screen is displayed, use the **TUNE** knob or keys **1** ~ **6** to select the desired mode.

### 4. **PHONE** (for *Bluetooth®* Wireless Technology equipped model)

- Operates Phone Screen
- ※ When a phone is not connected, the connection screen is displayed.

### 5. PWR/VOL knob

- **Power Knob**: Turns power On/Off by pressing the knob
- **Volume Knob**: Sets volume by turning the knob left/right



6. **SEEK TRACK**

- Radio Mode : Automatically searches for broadcast frequencies.
- CD, USB, iPod, My Music modes
  - Shortly press the key (under 0.8 seconds): Moves to next or previous song (file)
  - Press and hold the key (over 0.8 seconds): Rewinds or fast-forwards the current song.

7. **FOLDER**

- CD MP3, USB mode : Folder Search

8. **1 ~ 6** (Preset)

- Radio Mode: Saves frequencies (channels) or receives saved frequencies (channels)
- CD, USB, iPod, My Music mode
  - **1 RPT** : Repeat
  - **2 RDM** : Random
- In the Radio, Media, Setup, and Menu pop up screen, the number menu is selected.

9. **DISP**

- Each time the button is shortly pressed (under 0.8 seconds), sets screen Off → Screen On → Screen Off
- \* Audio operation is maintained and only the screen will be turned Off. In the screen Off state, press any key to turn the screen On again.

10. **SCAN**

- Radio Mode
  - Press the key (under 0.8 seconds): Previews each broadcast for 5 seconds each
- CD, USB, My Music mode
  - Press the key (under 0.8 seconds): Previews each song (file) for 10 seconds each
- \* Press the key again to continue listening to the current song (file).

11. **SETUP CLOCK**

- Shortly press the key (under 0.8 seconds) : Moves to the Display, Sound, Clock, Phone, System setting modes
- Press and hold the key (over 0.8 seconds) : Move to the Time setting screen

12. **MEMU**

- Displays menus for the current mode.
- \* iPod List : Move to parent category

### 13. TUNE knob

- Radio mode : Changes frequency by turning the knob left/right
- CD, USB, iPod, My Music mode: Searches songs (files) by turning the knob left/right
- \* When the desired song is displayed, press the knob to play the song.
- Moves focus in all selection menus and selects menus



### 14. DISC-IN LED

- LED that indicates whether a disc is inserted.



### 15. FM

- Changes to FM mode.
- Each time the key is pressed, the mode changed in order of FM1 → FM2.

### 16. AM

- Changes to AM mode.

## SETUP (for RDS model)

- AM104DMEE, AM114DMEE

### Display Settings

Press the **SETUP** key ▶ Select [Display] through **TUNE** knob or **1 RPT** key ▶ Select menu through **TUNE** knob

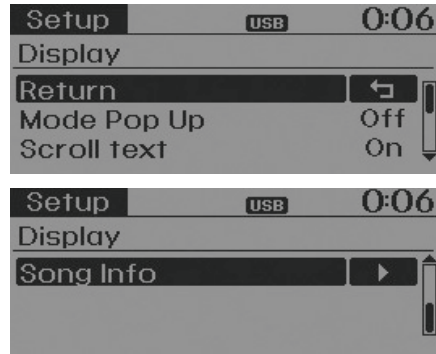

### Mode Pop up

[Mode Pop up] ▶ Changes  On selection mode

- During On state, press the **RADIO** or **MEDIA** key to display the mode change pop up screen.

### Scroll text

[Scroll text] ▶ Set  On /  Off

- On : Maintains scroll
- Off : Scrolls only one time.

### Song Info

When playing an MP3 file, select the desired display info from 'Folder/File' or 'Album/Artist/Song'.

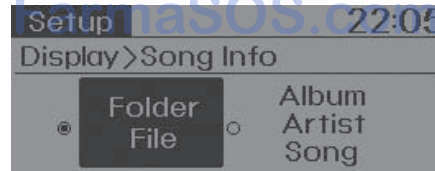

### Sound Settings

Press the **SETUP** key ▶ Select [Sound] through **TUNE** knob or **2 RDM** key ▶ Select menu through **TUNE** knob

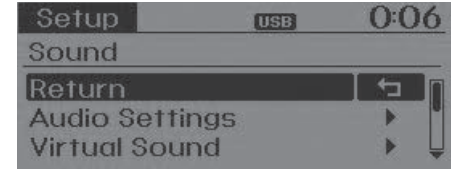

## Audio Settings

This menu allows you to set the 'Bass, Middle, Treble' and the Sound Fader and Balance.

Select [Audio Settings] ▶ Select menu through **⊙** TUNE knob ▶ Turn **⊙** TUNE knob left/right to set

- Bass, Middle, Treble : Selects the sound tone.
- Fader, Balance : Moves the sound fader and balance.
- Default : Restores default settings.
- \* Return : While adjusting values, re-pressing the **⊙** TUNE knob will restore the parent menu.

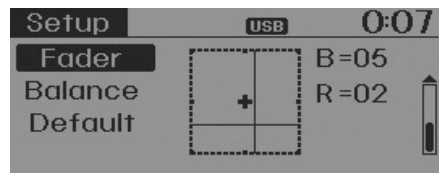
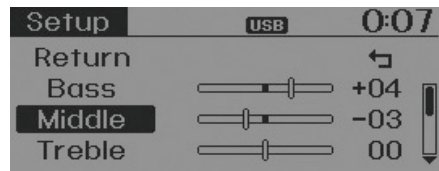

## Virtual Sound

The PowerBass, PowerTreble, and Sound Surround can be set.

Select [Virtual Sound] ▶ Set menu through **⊙** TUNE knob ▶ Set  On /  Off through **⊙** TUNE knob

- PowerBass : This is a sound system feature that provides live bass.
- PowerTreble : This is a sound system feature that provides live tremble.
- Surround : This is a sound system feature that provides surround sound.

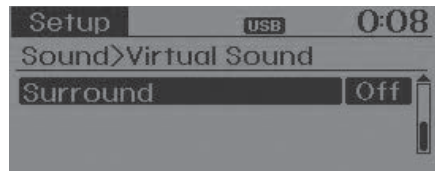
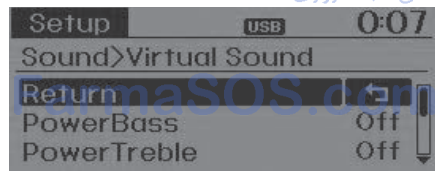

\* May differ depending on the selected audio.

## Speed Dependent Volume Control

This feature is used to automatically control the volume level according to the speed of the vehicle.

Select [Speed Dependent Vol.] ▶ Set in 4 levels [Off/Low/Mid/High] of **⊙** TUNE knob



## Volume Dialogue

Adjusts voice recognition volume.

Select [Volume Dialogue] ▶ Set volume of **⊙** TUNE knob



## Clock Settings

Press the **SETUP** key ▶ Select [Clock] through **TUNE** knob or **3** key ▶ Select menu through **TUNE** knob

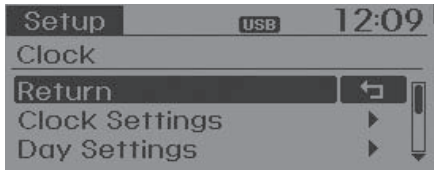

## Clock Settings

This menu is used to set the time.

Select [Clock Settings] ▶ Set through **TUNE** knob ▶ Press **TUNE** knob

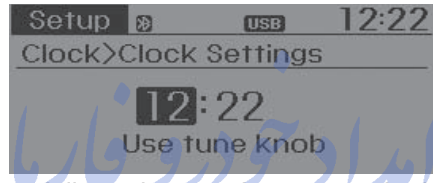

\* Adjust the number currently in focus to set the [hour] and press the tune knob to set the [minute].

تلفن شبانه روزی: ۰۲۱-۸۸۸۶۲۰۸۵

FarmaSOS.com

## Day Settings

This menu is used to set the date (DD/MM/YYYY).

Select [Day Settings] ▶ Set through **TUNE** knob ▶ Press **TUNE** knob

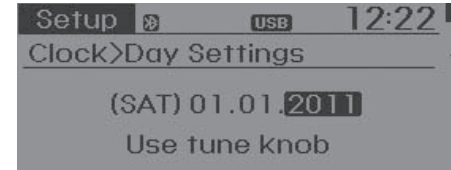

\* Adjust the number currently in focus to make the settings and press the tune knob to move to the next setting. (Set in order of Year/Month/Day)



### Time Format

This function is used to set the 12/24 hour time format of the audio system.

Select [Time Format] ▶ Set 12Hr / 24Hr through  TUNE knob

### Clock Display when Power is OFF

Select [Clock Disp.(Pwr Off)] ▶ Set  /  through  TUNE knob

- : Displays time/date on screen
- : Turn off.

### Automatic RDS Time

This option is used to automatically set the time by synchronizing with RDS.

Select [Automatic RDS Time] ▶ Set  /  through  TUNE knob

- : Turn on Automatic Time
- : Turn off.

امداد خودرو فارما

تلفن شبانه روزی: ۰۲۱-۸۸۸۶۲۰۸۵

FarmaSOS.com

## Phone Setup (for RDS, Bluetooth® Wireless Technology equipped model)

Press the **SETUP** key ▶ Select [Phone]  
through **TUNE** knob or **4** key ▶  
Select menu through **TUNE** knob

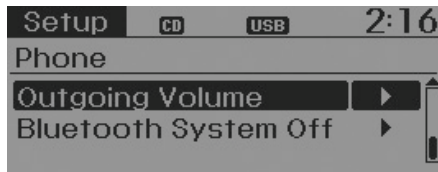
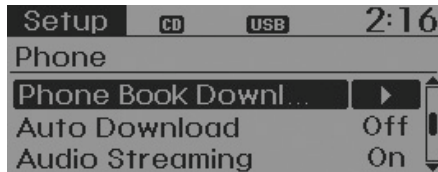
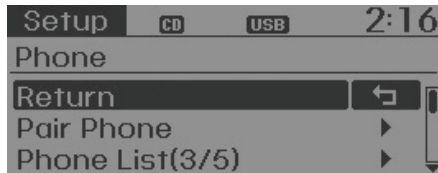

### ⚠ CAUTION

*To pair a Bluetooth® Wireless Technology enabled mobile phone, authentication and connection processes are first required. As a result, you cannot pair your mobile phone while driving the vehicle. First park your vehicle before use.*

تلفن شبانه روزی: ۰۲۱-۸۸۸۶۲۰۸۵

FarmaSOS.com

## Pair Phone

Select [Pair Phone] ▶ Set through **TUNE** knob

- ① Search for device names as displayed on your mobile phone and connect.
- ② Input the passkey displayed on the screen. (Passkey : 0000)

\* The device name and passkey will be displayed on the screen for up to 3 minutes. If pairing is not completed within the 3 minutes, the mobile phone pairing process will automatically be canceled.

### Phone List

The names of up to 5 paired phones will be displayed.



A [▶] is displayed in front of the currently connected phone.

Select the desired name to setup the selected phone.

- Connecting a phone  
Select [Phone List]▶Select mobile phone through  TUNE knob▶  
Select [Connect Phone]

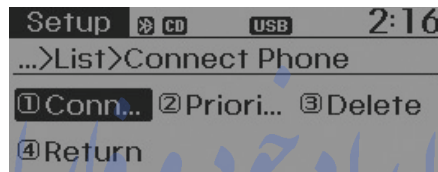

- ① Select a mobile phone that is not currently connected.
  - ② Connect the selected mobile phone.
  - ③ Connection completion is displayed.
- \* If a phone is already connected, disconnect the currently connected phone and select a new phone to connect.

- Disconnecting a connected phone  
Select [Phone List]▶Select mobile phone through  TUNE knob▶  
Select [Disconnect Phone]

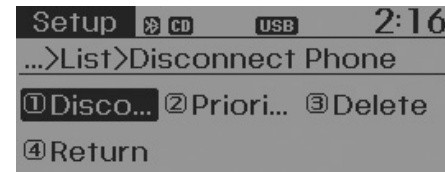

- ① Select the currently connected mobile phone.
- ② Disconnect the selected mobile phone.
- ③ Disconnection completion is displayed.

- Changing connection sequence (Priority)

This is used to change the order (priority) of automatic connection for the paired mobile phones.

Select [Phone List] ▶ Select [Priority] through  TUNE knob ▶ Select No. 1 Priority mobile phone

- ① Select [Priority].
  - ② From the paired phones, select the phone desired for No.1 priority.
  - ③ The changed priority sequence is displayed.
- \* Once the connection sequence (priority) is changed, the new no. 1 priority mobile phone will be connected.
- when the no. 1 priority cannot be connected: Automatically attempts to connect the most recently connected phone.
  - Cases when the most recently connected phone cannot be connected: Attempts to connect in the order in which paired phones are listed.

- The connected phone will automatically be changed to No. 1 priority.

- Delete

Select [Phone List] ▶ Select mobile phone through  TUNE knob ▶ Select [Delete]

- ① Select the desired mobile phone.
  - ② Delete the selected mobile phone.
  - ③ Deletion completion is displayed.
- \* When attempting to delete a currently connected phone, the phone is first disconnected.

#### CAUTION

- ***When you delete a mobile phone, the mobile phone phone book will also be erased.***
- ***For stable Bluetooth® Wireless Technology communication, delete the mobile phone from the audio and also delete the audio from your mobile phone.***

## Phone book Download

This feature is used to download phone book and call histories into the audio system.

Select [Phone book Download] ▶ Select through  TUNE knob

#### CAUTION

- ***The download feature may not be supported in some mobile phones.***
- ***If a different operation is performed while phone book is being downloaded, downloading will be discontinued. Phone book already downloaded will be saved.***
- ***When downloading new phone book, delete all previously saved phone book before starting download.***

### Auto Download

When connecting a mobile phone, it is possible to automatically download new phone book and Call Histories.

Select [Auto Download] ▶ Set  On /  Off through  TUNE knob

### Audio Streaming

Songs (files) saved in your *Bluetooth*<sup>®</sup> Wireless Technology enabled mobile phone can be played through the audio system.

Select [Audio Streaming] ▶ Set  On /  Off through  TUNE knob

#### CAUTION

*The *Bluetooth*<sup>®</sup> Wireless Technology audio streaming feature may not be supported in some mobile phones.*

### Outgoing Volume

This is used to set the volume of your voice as heard by the other party while on a *Bluetooth*<sup>®</sup> Wireless Technology enabled handsfree call.

Select [Outgoing Volume] ▶ Set volume through  TUNE knob

\* Even while on a call, the volume can be changed by using the  key.

تلفن شبانه روزی: ۰۲۱-۸۸۸۶۲۰۸۵

FarmaSOS.com

### *Bluetooth*<sup>®</sup> Wireless Technology System Off

This feature is used when you do not wish to use the *Bluetooth*<sup>®</sup> Wireless Technology system.

Select [Bluetooth System Off] ▶ Set through  TUNE knob

\* If a phone is already connected, disconnect the currently connected phone and turn the *Bluetooth*<sup>®</sup> Wireless Technology system off.

## Using the *Bluetooth*<sup>®</sup> Wireless Technology System

To use *Bluetooth*<sup>®</sup> Wireless Technology when the system is currently off, follow these next steps.

- Turning On *Bluetooth*<sup>®</sup> Wireless Technology through the **PHONE** Key  
Press the **PHONE** key ▶ Screen Guidance
- \* Moves to the screen where *Bluetooth*<sup>®</sup> Wireless Technology functions can be used and displays guidance.

- Turning On *Bluetooth*<sup>®</sup> Wireless Technology through the **SETUP** Key  
Press the **SETUP** key ▶ Select [Phone] through **TUNE** knob or **3** key

- ① A screen asking whether to turn on *Bluetooth*<sup>®</sup> Wireless Technology will be displayed.
  - ② On the screen, select **YES** to turn on *Bluetooth*<sup>®</sup> Wireless Technology and display guidance.
- \* If the *Bluetooth*<sup>®</sup> Wireless Technology system is turned on, the system will automatically try to connect the most recently connected *Bluetooth*<sup>®</sup> Wireless Technology mobile phone.

FarmaSOS.com

## CAUTION

*Bluetooth*<sup>®</sup> Wireless Technology connection may become intermittently disconnected in some mobile phones. Follow these next steps to try again.

- 1) Turn the *Bluetooth*<sup>®</sup> Wireless Technology function within the mobile phone ON/OFF and try to connect again.
- 2) Turn the mobile phone power ON/OFF and try to connect again.
- 3) Completely remove the mobile phone battery, reboot, and then try to connect again.
- 4) Reboot the audio system and try to connect again
- 5) Delete all paired devices in your mobile phone and the audio system and pair again for use.

### System Settings

Press the **SETUP** key ▶ Select [System] through tune knob or **5** key ▶ Select menu through **TUNE** knob

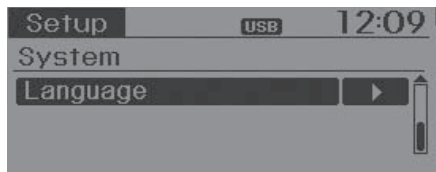
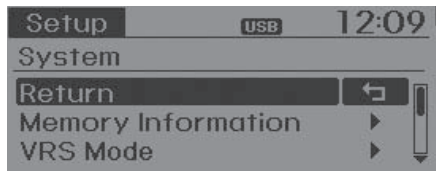

### Memory Information (if equipped)

Displays currently used memory and total system memory.

Select [Memory Information] ▶ OK

The currently used memory is displayed on the left side while the total system memory is displayed on the right side.



### VRS Mode

This feature is used to change voice command feedback between Normal and Expert modes.

Select [VRS Mode] ▶ Set through **TUNE** knob

- Normal : This mode is for beginner users and provides detailed instructions during voice command operation.
- Expert : This mode is for expert users and omits some information during voice command operation. (When using Expert mode, guidance instructions can be heard through the [Help] or [Menu] commands.

\* May differ depending on the selected audio.

FarmaSOS.com

## Language

This menu is used to set the display and voice recognition language.

Select [Language]▶Set through  TUNE knob







\* The system will reboot after the language is changed.

- \* Language support by region
  - Deutsch, English(UK), Français, Italiano, Español, Nederlands, Svenska, Dansk, Русский, Polski

## SETUP

- AM100DMMG, AM110DMMG, AM111DMMG, AM101DMGG, AM110DMEE, AM111DMEE, AM112DMEE, AM113DMEE, AM110DMGL, AM111DMGL, AM100DMMN, AM110DMMN

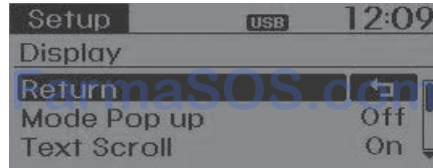

## Display Settings

Press the  key▶Select [Display] through  TUNE knob or  key▶Select menu through  TUNE knob





## Mode Pop up

[Mode Pop up]▶Changes  selection mode

- During On state, press the  or  key to display the mode change pop up screen.

## Text Scroll

[Text Scroll ]▶Set / 

-  : Maintains scroll
-  : Scrolls only one (1) time.

## Media Display

When playing an MP3 file, select the desired display info from 'Folder/File' or 'Album/Artist/Song'.





## SOUND SETTINGS

Press the **SETUP** key ▶ Select [Sound] through **TUNE** knob or **2 RDM** key ▶ Select menu through **TUNE** knob

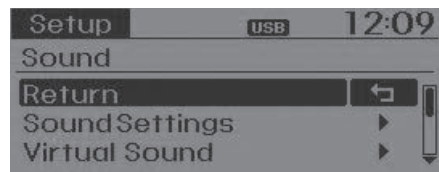

## Sound Settings

This menu allows you to set the 'Bass, Middle, Treble' and the Sound Fader and Balance.

Select [Sound Settings] ▶ Select menu through **TUNE** knob ▶ Turn **TUNE** knob left/right to set

- Bass, Middle, Treble : Selects the sound tone.
- Fader, Balance : Moves the sound fader and balance.
- Default : Restores default settings.
- \* Return : While adjusting values, re-pressing the **TUNE** knob will restore the parent menu.

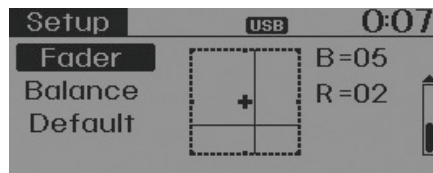
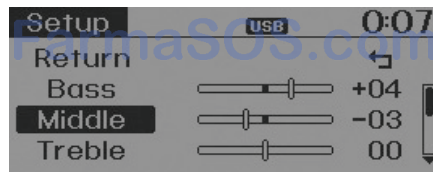

## Virtual Sound

The PowerBass, PowerTreble, and Sound Surround can be set.

Select [Virtual Sound] ▶ Set menu through **TUNE** knob ▶ Set **On** / **Off** through **TUNE** knob

- PowerBass : This is a sound system feature that provides live bass.
- PowerTreble : This is a sound system feature that provides live tremble.
- Surround : This is a sound system feature that provides surround sound.

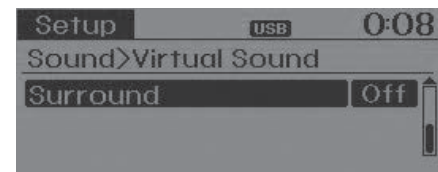
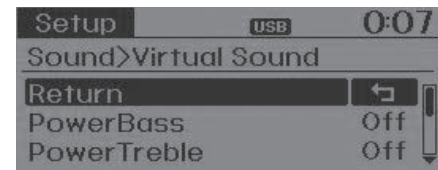

\* May differ depending on the selected audio.



## Speed Dependent Volume Control

This feature is used to automatically control the volume level according to the speed of the vehicle.

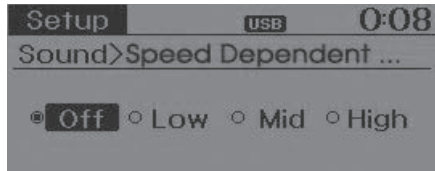
Select [Speed Dependent Vol.] ▶ Set in 4 levels [Off/Low/Mid/High] of 



## Clock Settings

Press the  key ▶ Select [Clock] through  TUNE knob or  key ▶ Select menu through  TUNE knob

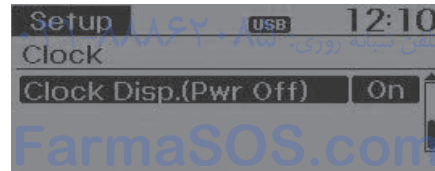
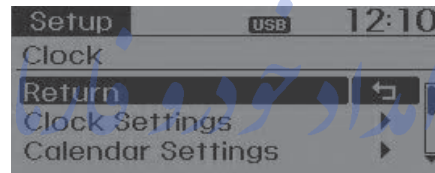

## Clock Settings

This menu is used to set the time.

Select [Clock Settings] ▶ Set through  TUNE knob ▶ Press 



\* Adjust the number currently in focus to set the [hour] and press the tune knob to set the [minute].

### Calendar Settings

This menu is used to set the date (DD/MM/YYYY).

Select [Calendar Settings] ▶ Set through  TUNE knob ▶ Press  TUNE knob

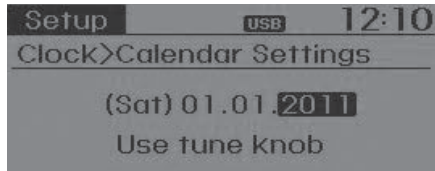

\* Adjust the number currently in focus to make the settings and press the tune knob to move to the next setting. (Set in order of Year/Month/Day)

### Clock Display when Power is OFF

Select [Clock Disp.(Pwr Off)] ▶ Set  On /  Off through  TUNE knob

- On : Displays time/date on screen
- Off : Turn off.

امداد خودرو فارما

تلفن شبانه روزی: ۰۲۱-۸۸۸۶۲۰۸۵

FarmaSOS.com

## Phone Setup (for *Bluetooth®* Wireless Technology equipped model)

Press the **SETUP** key ▶ Select [Phone] through **TUNE** knob or **4** key ▶ Select menu through **TUNE** knob

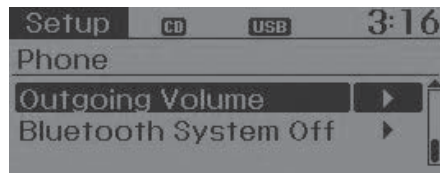
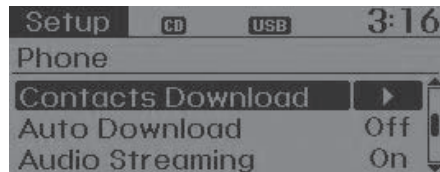

## Pair Phone

### ⚠ CAUTION

*To pair a Bluetooth® Wireless Technology enabled mobile phone, authentication and connection processes are first required. As a result, you cannot pair your mobile phone while driving the vehicle. First park your vehicle before use.*

Select [Pair Phone] ▶ Set through **TUNE** knob

- ① Search for device names as displayed on your mobile phone and connect.
  - ② Input the passkey displayed on the screen. (Passkey : 0000)
- \* The device name and passkey will be displayed on the screen for up to 3 minutes. If pairing is not completed within the 3 minutes, the mobile phone pairing process will automatically be canceled.

- ③ Pairing completion is displayed.
- \* In some mobile phones, pairing will automatically be followed by connection.
- \* It is possible to pair up to five *Bluetooth®* Wireless Technology enabled mobile phones.

### Phone List

The names of up to 5 paired phones will be displayed.

A [▶] is displayed in front of the currently connected phone.

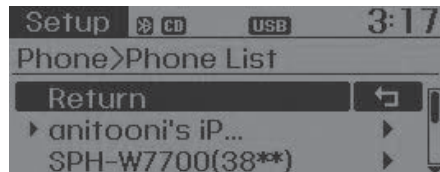

Select the desired name to setup the selected phone.

#### • Connecting a phone

Select [Phone List] ▶ Select mobile phone through  TUNE knob ▶ Select [Connect Phone]

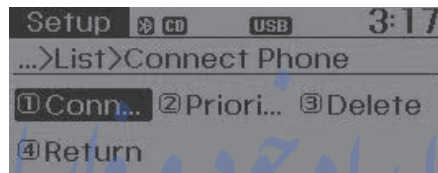

- ① Select a mobile phone that is not currently connected.
- ② Connect the selected mobile phone. تلفن شبانه روزی: ۰۸۵۰۸۶۲۰۸۵
- ③ Connection completion is displayed.

\* If a phone is already connected, disconnect the currently connected phone and select a new phone to connect.

#### • Disconnecting a connected phone

Select [Phone List] ▶ Select mobile phone through  TUNE knob ▶ Select [Disconnect Phone]

- ① Select the currently connected mobile phone.

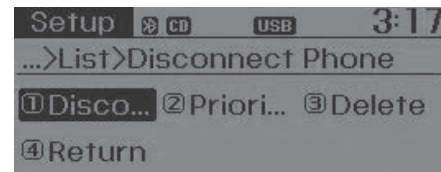

- ② Disconnect the selected mobile phone.
- ③ Disconnection completion is displayed.

- Changing connection sequence (Priority)

This is used to change the order (priority) of automatic connection for the paired mobile phones.

Select [Phone List] ▶ Select [Priority] through  TUNE knob ▶ Select No. 1 Priority mobile phone

- ① Select [Priority].
  - ② From the paired phones, select the phone desired for No.1 priority.
  - ③ The changed priority sequence is displayed.
- \* Once the connection sequence (priority) is changed, the new no. 1 priority mobile phone will be connected.
- when the no. 1 priority cannot be connected: Automatically attempts to connect the most recently connected phone.
  - Cases when the most recently connected phone cannot be connected: Attempts to connect in the order in which paired phones are listed.

- The connected phone will automatically be changed to No. 1 priority.

- Delete

Select [Phone List] ▶ Select mobile phone through  TUNE knob ▶ Select [Delete]

- ① Select the desired mobile phone.
  - ② Delete the selected mobile phone.
  - ③ Deletion completion is displayed.
- \* When attempting to delete a currently connected phone, the phone is first disconnected.

### CAUTION

- **When you delete a mobile phone, the mobile phone contacts will also be erased.**
- **For stable Bluetooth® Wireless Technology communication, delete the mobile phone from the audio and also delete the audio from your mobile phone.**

## Contacts Download

This feature is used to download contacts and call histories into the audio system.

Select [Contacts Download] ▶ Select through  TUNE knob

### CAUTION

- **The download feature may not be supported in some mobile phones.**
- **If a different operation is performed while Contacts are being downloaded, downloading will be discontinued. Contacts already downloaded will be saved.**
- **When downloading new Contacts, delete all previously saved Contacts before starting download.**

### Auto Download

When connecting a mobile phone, it is possible to automatically download new Contacts and Call Histories.

Select [Auto Download] ▶ Set  On /  Off through  TUNE knob

### Audio Streaming

Songs (files) saved in your *Bluetooth*<sup>®</sup> Wireless Technology enabled mobile phone can be played through the audio system.

Select [Audio Streaming] ▶ Set  On /  Off through  TUNE knob

#### CAUTION

**The *Bluetooth*<sup>®</sup> *Wireless Technology* audio streaming feature may not be supported in some mobile phones.**

### Outgoing Volume

This is used to set the volume of your voice as heard by the other party while on a *Bluetooth*<sup>®</sup> Wireless Technology enabled handsfree call.

Select [Outgoing Volume] ▶ Set volume through  TUNE knob

\* Even while on a call, the volume can be changed by using the  key.

تلفن شبانه روزی: ۰۲۱-۸۸۸۶۲۰۸۵

FarmaSOS.com

## **Bluetooth® Wireless Technology System Off**

This feature is used when you do not wish to use the *Bluetooth®* Wireless Technology system.

Select [Bluetooth System Off] ▶ Set through  TUNE knob

\* If a phone is already connected, disconnect the currently connected phone and turn the *Bluetooth®* Wireless Technology system off.

## **Using the Bluetooth® Wireless Technology System**

To use *Bluetooth®* Wireless Technology when the system is currently off, follow these next steps.

- Turning On *Bluetooth®* Wireless Technology through the **PHONE** Key  
Press the **PHONE** key ▶ Screen Guidance
- \* Moves to the screen where *Bluetooth®* Wireless Technology functions can be used and displays guidance.

- Turning On *Bluetooth®* Wireless Technology through the **SETUP** Key  
Press the **SETUP** key ▶ Select [Phone] through  TUNE knob or **4** key

- ① A screen asking whether to turn on *Bluetooth®* Wireless Technology will be displayed.
  - ② On the screen, select **YES** to turn on *Bluetooth®* Wireless Technology and display guidance.
- \* If the *Bluetooth®* Wireless Technology system is turned on, the system will automatically try to connect the most recently connected *Bluetooth®* Wireless Technology mobile phone.

FarmaSOS.com

## **CAUTION**

*Bluetooth®* Wireless Technology connection may become intermittently disconnected in some mobile phones. Follow these next steps to try again.

- 1) Turn the *Bluetooth®* Wireless Technology function within the mobile phone ON/OFF and try to connect again.
- 2) Turn the mobile phone power ON/OFF and try to connect again.
- 3) Completely remove the mobile phone battery, reboot, and then try to connect again.
- 4) Reboot the audio system and try to connect again
- 5) Delete all paired devices in your mobile phone and the audio system and pair again for use.



## SYSTEM SETTINGS

Press the **SETUP** key ▶ Select [System] through tune knob or **5** key ▶ Select menu through **TUNE** knob



## Memory Information (if equipped)

Displays currently used memory and total system memory.

Select [Memory Information] ▶ OK

The currently used memory is displayed on the left side while the total system memory is displayed on the right side.



## Language

This menu is used to set the display and voice recognition language.

Select [Language] ▶ Set through **TUNE** knob

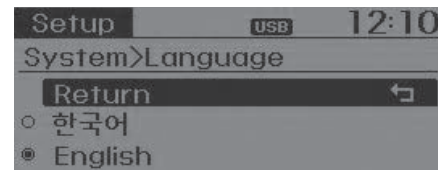

\* The system will reboot after the language is changed.

\* Language support by region  
- 한국어, English

FarmaSOS.com

## RADIO (for RDS model)

### Changing RADIO mode

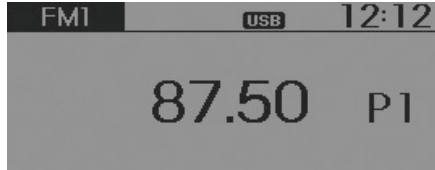

Press the **RADIO** key to change the mode in order of FM1 → FM2 → FMA → AM → AMA.

Press the **FM** or **AM** key to change the mode in order of FM1 → FM2 and AM.

[Mode Pop up] On state : Displays the change radio mode pop up screen. While the pop up screen is displayed, you can change the radio mode (**RADIO** : FM1 → FM2 → FMA → AM → AMA / **FM** : FM1 → FM2 / **AM** : AM) through the tune knob or **1** ~ **5** keys.

### Adjust Volume

Turn the **VOL** knob left/right to adjust the volume.

### SEEK

Press the **SEEK TRACK** key

- Shortly pressing the key (under 0.8 seconds): Changes the frequency.
- Pressing and holding the key (over 0.8 seconds): Automatically searches for the next frequency.

### Preset SEEK

Press the **1** ~ **6** key

- Shortly pressing the key (under 0.8 seconds): Plays the frequency saved in the corresponding key.
- Pressing and holding the key (over 0.8 seconds): Pressing and holding the desired key from **1** ~ **6** will save the currently playing broadcast to the selected key and sound a BEEP.

### SCAN

Press the **SCAN** key

- Shortly pressing the key (under 0.8 seconds): The broadcast frequency increases and previews each broadcast for 5 seconds each. After scanning all frequencies, returns and plays the current broadcast frequency.
- Pressing and holding the key (over 0.8 seconds): Previews the broadcasts saved in Preset **1** ~ **6** for 5 seconds each.

Press the **TA SCAN** key

- Pressing and holding the key (over 0.8 seconds): The broadcast frequency increases and previews each broadcast for 5 seconds each. After scanning all frequencies, returns and plays the current broadcast frequency.

### Selecting through manual search

Turn the **TUNE** knob left/right to adjust the frequency.

- AM104DMEE/ AM114DMEE
  - FM : Changes by 50KHz
  - AM : Changes by 9kHz

### Traffic Announcement (TA)

Shortly pressing the **TA SCAN** key (under 0.8 seconds): Set **On/Off** (TA Traffic Announcement) mode.

### PTY Up/Down

- Press the **PTY FOLDER** key when searching PTY in RDS Broadcasting Program Type selection.

### MENU

Within **MENU** key are the A.Store (Auto Store) and Info functions.

### AST (Auto Store)

Press the **MENU** key ▶ Set [**1**AST] through **TUNE** knob or **1 RPT** key.



Select AST (Auto Store) to save frequencies with superior reception to presets **1** ~ **6**. If no frequencies are received, then the most recently received frequency will be broadcast.

\* Saves only to the Preset memory **1** ~ **6** of FMA or AMA mode.

### AF (Alternative Frequency)

Press the **MENU** key ▶ Set [**2**AF] through **TUNE** knob or **2 RDM** key.

The Alternative Frequency option can be turned On/Off.

### Region

Press the **MENU** key ▶ Set [**3**Region] through **TUNE** knob or **3** key.

The Region option can be turned On/Off.

### News

Press the **MENU** key ▶ Set [**4**News] through **TUNE** knob or **4** key.

The News option can be turned On/Off.

### Info Volume

Info Volume refers to the sound volume upon receiving News or Traffic information.

The info volume can be controlled by turning the **VOL** knob left/right while a news or traffic broadcast is playing.

\* AF, Region, and News are RDS Radio menus.

## RADIO

### Changing RADIO mode



Press the **RADIO** key to change the mode in order of FM1 → FM2 → AM.

Press the **FM** or **AM** key to change the mode in order of FM1 → FM2 and AM.

- When the power is off, press the **RADIO** or **FM** **AM** key to turn on the audio system and receive radio broadcasts.

[Mode Pop up] On state : Displays the change radio mode pop up screen. While the pop up screen is displayed, you can change the radio mode (**RADIO** : FM1 → FM2 → AM / **FM** : FM1 → FM2 / **AM** : AM) through the tune knob or **1** ~ **5** keys.

### Adjust Volume

Turn the **VOL** knob left/right to adjust the volume.

### SEEK

Press the **SEEK TRACK** key

- Shortly pressing the key (under 0.8 seconds): Changes the frequency.
- Pressing and holding the key (over 0.8 seconds): Automatically searches for the next frequency.

### Preset SEEK

Press the **1** ~ **6** key

- Shortly pressing the key (under 0.8 seconds): Plays the frequency saved in the corresponding key.
- Pressing and holding the key (over 0.8 seconds): Pressing and holding the desired key from **1** ~ **6** will save the currently playing broadcast to the selected key and sound a BEEP.

### SCAN

Press the **SCAN** key

- Shortly pressing the key (under 0.8 seconds): The broadcast frequency increases and previews each broadcast for 5 seconds each. After scanning all frequencies, returns and plays the current broadcast frequency.
- Pressing and holding the key (over 0.8 seconds): Previews the broadcasts saved in Preset **1** ~ **6** for 5 seconds each.

### Selecting through manual search

Turn the  TUNE knob left/right to adjust the frequency.

- AM110DMEE/AM111DMEE/  
AM112DMEE/AM113DMEE
  - FM : Changes by 50kHz
  - AM : Changes by 9kHz
- AM110DMMG/AM110DMMG/  
AM111DMMG/AM101DMGG/  
AM101DMCG/AM111DMCG
  - FM : Changes by 100kHz
  - AM : Changes by 9kHz
- AM110DMGL/ AM100DMMN/  
AM110DMMN
  - FM : Changes by 200kHz
  - AM : Changes by 10kHz
- AM111DMGL
  - FM : Changes by 100kHz
  - AM : Changes by 10kHz

### MENU

Within **MENU** key are the A.Store (Auto Store) and Info functions.

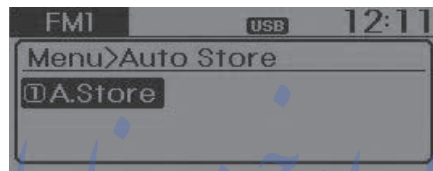

### A.Store (Auto Store)

Press the **MENU** key ▶ Set [**1** A.Store] through  TUNE knob or **1 RPT** key.

Select A.Store(Auto Store) to save frequencies with superior reception to presets **1** ~ **6**. If no frequencies are received, then the most recently received frequency will be broadcast.

## BASIC METHOD OF USE : Audio CD / MP3 CD / USB / iPod / My Music

Press the **MEDIA** key to change the mod mode in order of CD → USB(iPod) → AUX → My Music → BT Audio.

The folder/file name is displayed on the screen.



<Audio CD>



<CD MP3>



<USB>



<My Music>

\* The CD is automatically played when a CD is inserted.

\* The USB music is automatically played when a USB is connected.

## Repeat

While song (file) is playing ► **1 RPT** (RPT) key

Audio CD, MP3 CD, USB, iPod, My Music mode: RPT on screen

- To repeat one song (Shortly pressing the key (under 0.8 seconds)): Repeats the current song.

MP3 CD, USB mode: FLD.RPT on screen

- To repeat folder (pressing twice): repeats all files within the current folder.

\* Press the **1 RPT** key again to turn off repeat.

### Random

While song (file) is playing ▶  (RDM) key

Audio CD, My Music mode: RDM on screen

- Random (Shortly pressing the key (under 0.8 seconds)): Plays all songs in random order.

MP3 CD, USB mode: FLD.RDM on screen

- Folder Random (Shortly pressing the key (under 0.8 seconds)): Plays all files within the current folder in random order.

iPod mode: ALB RDM on screen

- Album Random (Shortly pressing the key (under 0.8 seconds)): Plays all files within albums of the current category in random order.

MP3 CD, USB, iPod mode: ALL RDM on screen

- All Random (pressing twice): Plays all files in random order.
- ※ Press the  key again to turn off repeat.

### Changing Song/File

While song (file) is playing ▶  key

- Shortly pressing the key (under 0.8 seconds): Plays the current song from the beginning.

※ If the  key is pressed again within 1 second, the previous song is played.

- Pressing and holding the key (over 0.8 seconds): Rewinds the song.

While song (file) is playing ▶  key

- Shortly pressing the key (under 0.8 seconds): Plays the next song.
- Pressing and holding the key (over 0.8 seconds): Fast forwards the song.

### Scan (for RDS model)

While song (file) is playing ▶  key

- Pressing and holding the key (over 0.8 seconds) : Scans all songs for 10 seconds starting from the next song.



※ Pressing and holding the  key again to turn off.

### Scan



While song (file) is playing ▶  key

- Shortly pressing the key (under 0.8 seconds) : Scans all songs from the next song for 10 seconds each.
- ※ Press the  key again to turn off.
- ※ The SCAN function is not supported in iPod mode.

### Folder Search : MP3 CD, USB Mode



While file is playing ▶  /  
 (Folder Up) key

- Searches the next folder.

While file is playing ▶  /  
 (Folder Down) key

- Searches the parent folder.
- \* If a folder is selected by pressing the  TUNE knob, the first file within the selected folder will be played.
- \* In iPod mode, moves to the Parent Folder.

### Searching Songs (File)





- Turning  TUNE knob : Searches for songs (files)
- Pressing  TUNE knob : Plays selected song (file).

### MENU : Audio CD

Press the CD MP3 mode  key to set the Repeat, Random, Information features.



### Repeat

Press the  key ▶ Set [] through the  TUNE knob or  key to repeat the current song.





- \* Press RPT again to turn off.

### Random

Press the  key ▶ Set [] through the  TUNE knob or  key to randomly play songs within the current folder.

- \* Press RDM again to turn off.

### Information

Press the  key ▶ Set [] through the  TUNE knob or  key to display information of the current song.

- \* Press the  key to turn off info display.

### MENU : MP3 CD / USB

Press the CD MP3 mode  key to set the Repeat, Folder Random, Folder Repeat, All Random, Information, and Copy features.



### Repeat

Press the  key ▶ Set [] through the  TUNE knob or  key to repeat the current song.

- \* Press RPT again to turn off.



### Folder Random

Press the **MENU** key ▶ Set [**2** F.RDM] through the **TUNE** knob or **2 RDM** key to randomly play songs within the current folder.

h Press F.RDM again to turn off.

### Folder Repeat

Press the **MENU** key ▶ Set [**3** F.RPT] through the **TUNE** knob or **3** key to repeat songs within the current folder.

\* Press F.RPT again to turn off.

### All Random

Press the **MENU** key ▶ Set [**4** A.RDM] through the **TUNE** knob or **4** key to randomly play all songs within the CD.

\* Press A.RDM again to turn off.

### Information

Press the **MENU** key ▶ Set [**5** Info] through the **TUNE** knob or **5** key to display information of the current song.

\* Press the **MENU** key to turn off info display.

### Copy

Press the **MENU** key ▶ Set [**6** Copy] through the **TUNE** knob or **6** key.

This is used to copy the current song into My Music. You can play the copied Music in My Music mode.

\* If another key is pressed while copying is in progress, a pop up asking you whether to cancel copying is displayed.

\* If another media is connected or inserted (USB, CD, iPod, AUX) while copying is in progress, copying is canceled.

\* Music will not be played while copying is in progress.

FarmaSOS.com

## MENU : iPod

In iPod mode, press the **MENU** key to set the Repeat, Album Random, All Random, Information and Search features.



### Repeat

Press the **MENU** key ▶ Set [**1**RPT] through the **TUNE** knob or **1 RPT** key to repeat the current song.

\* Press RPT again to turn repeat off.

### Album Random

Press the **MENU** key ▶ Set [**2** Alb.RDM] through the **TUNE** knob or **2 RDM** key.

Plays albums within the currently playing category in random order.

\* Press Alb.RDM again to turn off.

### All Random

Press the **MENU** key ▶ Set [**3** A.RDM] through the **TUNE** knob or **3** key.

Plays all songs within the currently playing category in random order.

\* Press A.RDM again to turn off.

FarmaSOS.com

### Information

Press the **MENU** key ▶ Set [**4**Info] through the **TUNE** knob or **4** key.

Displays information of the current song.

\* Press the **MENU** key to turn off info display.

### Search

Press the **MENU** key ▶ Set [**5** Search] through the **TUNE** knob or **5** key.

Displays iPod category list.

\* Searching iPod category is **MENU** key pressed, move to parent category.

### MENU : My Music Mode (if equipped)

In My Music mode, press the **MENU** key to set the Repeat, Random, Information, Delete, Delete All, and Delete Selection features.



#### Repeat

Press the **MENU** key ▶ Set [**1**RPT] through the **TUNE** knob or **1 RPT** key.

Repeats the currently playing song.  
\* Press RPT again to turn repeat off.

#### Random

Press the **MENU** key ▶ Set [**2**RDM] through the **TUNE** knob or **2 RDM** key.

Plays all songs in random order.

\* Press RDM again to turn random off.

#### Information

Press the **MENU** key ▶ Set [**3**Info] through the **TUNE** knob or **3** key.

Displays information of the current song.

\* Press the **MENU** key to turn off info display.

#### Delete

Press the **MENU** key ▶ Set [**4**Delete] through the **TUNE** knob or **4** key.

Deletes currently playing file

In the play screen, pressing delete will delete the currently playing song.

Deletes file from list

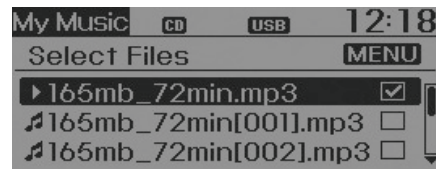

- ① Select the file you wish to delete by using the **TUNE** knob.
- ② Press the **MENU** key and select the delete menu to delete the selected file.

## Delete All

Press the **MENU** key ▶ Set [5] Del.All] through the **TUNE** knob or **5** key.

Deletes all songs of My Music.

## Delete Selection

Press the **MENU** key ▶ Set [6] Del.Sel] through the **TUNE** knob or **6** key.

Songs within My Music are selected and deleted.

- ① Select the songs you wish to delete from the list.

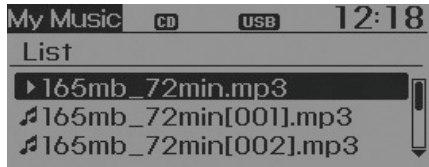

- ② After selecting, press the **MENU** key and select the delete menu.

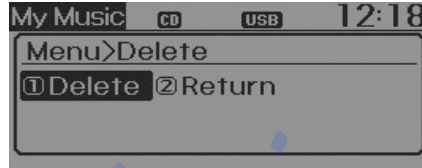

## \* NOTICE - Using the My Music

- Even if memory is available, a maximum of 6,000 songs can be stored.
- The same song can be copied up to 1,000 times.
- Memory info can be checked in the System menu of Setup.

## AUX

AUX is used to play external MEDIA currently connected with the AUX terminal.

AUX mode will automatically start when an external device is connected with the AUX terminal.

If an external device is connected, you can also press the **MEDIA** key to change to AUX mode.

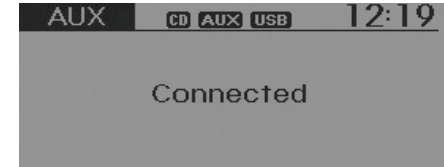

- \* AUX mode cannot be started unless there is an external device connected to the AUX terminal.

## \* NOTICE - USING THE AUX

Fully insert the AUX cable into the AUX terminal for use.

## **Bluetooth® Wireless Technology AUDIO (if equipped)**

### **What is Bluetooth® Wireless Technology?**

Bluetooth® Wireless Technology is a wireless technology that allows multiple devices to be connected in a short range, low-powered devices like hands-free, stereo headset, wireless remote controller, etc. For more information, visit the *Bluetooth®* Wireless Technology website at [www.Bluetooth.com](http://www.Bluetooth.com)

Before using *Bluetooth®* Wireless Technology audio features

- *Bluetooth®* Wireless Technology audio may not be supported depending on the compatibility of your *Bluetooth®* Wireless Technology mobile phone.
- In order to use *Bluetooth®* Wireless Technology audio, you must first pair and connect the *Bluetooth®* Wireless Technology mobile phone.
- *Bluetooth®* Wireless Technology audio can be used only when the [Audio Streaming] of Phone is turned On.  
\* Setting *Bluetooth®* Wireless Technology Audio Streaming :  
Press the **SETUP** key ▶ Select [Phone] through the tune knob ▶ Select [Audio Streaming] through the **TUNE** knob ▶ Set (On)/(Off)

### **Starting Bluetooth® Wireless Technology Audio**

- Press the **MEDIA** key to change the mode in order of CD → USB → AUX → My Music → BT Audio.
- If BT Audio is selected, *Bluetooth®* Wireless Technology audio will start playing.  
\* Audio may not automatically start playing in some mobile phones.

### **Using the Bluetooth® Wireless Technology audio features**

- Play / Pause

Press the **TUNE** knob to play and pause the current song.



- \* The previous song / next song / play / pause functions may not be supported in some mobile phones.

## PHONE (if equipped)

Before using the *Bluetooth*® Wireless Technology phone features

- In order to use *Bluetooth*® Wireless Technology phone, you must first pair and connect the *Bluetooth*® Wireless Technology mobile phone.
- If the mobile phone is not paired or connected, it is not possible to enter Phone mode. Once a phone is paired or connected, the guidance screen will be displayed.
- If Priority is set upon vehicle ignition (IGN/ACC ON), the *Bluetooth*® Wireless Technology phone will be automatically connected. Even if you are outside, the *Bluetooth*® Wireless Technology phone will be automatically connected once you are in the vicinity of the vehicle. If you do not want automatic *Bluetooth*® Wireless Technology phone connection, set the *Bluetooth*® Wireless Technology power to OFF.

## Making a call using the Steering remote controller

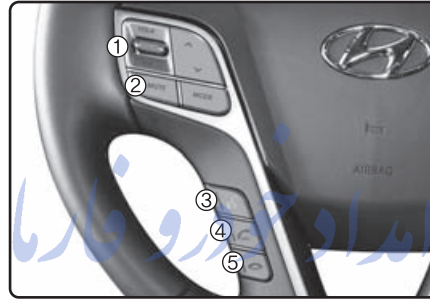

1. VOLUME button : Raises or lowers speaker volume.
2. MUTE button : Mute the microphone during a call.
3. button : Activates voice recognition.
4. button : Places and transfers calls.
5. button : Ends calls or cancels functions.

- Check call history and making call
  - ① Shortly press (under 0.8 seconds) the key on the steering remote controller.
  - ② The call history list will be displayed on the screen.
  - ③ Press the key again to connect a call to the selected number.
- Redialing the most recently called number
  - ① Press and hold (over 0.8 seconds) the key on the steering remote controller.
  - ② The most recently called number is redialed.

### Phone MENU (for RDS model)

Press the **PHONE** key to display three menus (Call History, Phone Book, Phone Setup).

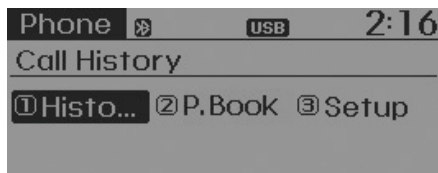

### Call history

Press the **PHONE** key ▶ Set [**1** History] through the **TUNE** knob or **1 RPT** key.

The call history is displayed and can be used to select a number and make a call.

If call history does not exist, a screen asking whether to download call history is displayed. (The download feature may not be supported in some mobile phones)

### Phone Book

Press the **PHONE** key ▶ Set [**2** P. Book] through the **TUNE** knob or **2 RDM** key.

The phone book is displayed and can be used to select a number and make a call.

\* If more than one number is saved to one contact, then a screen showing the mobile phone number, Home and office number is displayed. Select the desired number to make the call.

\* If phone book do not exist, a screen asking whether to download phone book is displayed. (The download feature may not be supported in some mobile phones)

### Phone Setup

Press the **PHONE** key ▶ Set [**3** Setup] through the **TUNE** knob or **3** key.

The *Bluetooth*® Wireless Technology mobile phone setup screen is displayed. For more information, refer to "Phone Setup".

## Phone MENU

Press the **PHONE** key to display three menus (Call History, Contacts, Phone Setup).



### Call history

Press the **PHONE** key ▶ Set [**1** History] through the **TUNE** knob or **1 RPT** key.

The call history is displayed and can be used to select a number and make a call.

If call history does not exist, a screen asking whether to download call history is displayed. (The download feature may not be supported in some mobile phones)

### Contacts

Press the **PHONE** key ▶ Set [**2** Contacts] through the **TUNE** knob or **2 RDM** key.

The Contacts are displayed and can be used to select a number and make a call.

\* If more than one number is saved to one contact, then a screen showing the mobile phone number, Home and office number is displayed. Select the desired number to make the call.

\* If Contacts do not exist, a screen asking whether to download Contacts is displayed. (The download feature may not be supported in some mobile phones)

### Phone Setup

Press the **PHONE** key ▶ Set [**3** Setup] through the **TUNE** knob or **3** key.

The *Bluetooth*<sup>®</sup> Wireless Technology mobile phone setup screen is displayed. For more information, refer to "Phone Setup".



**\* NOTICE - USING THE**

***Bluetooth*<sup>®</sup> Wireless Technology  
CELLULAR PHONE**

- Do not use a cellular phone or perform *Bluetooth*<sup>®</sup> Wireless Technology settings (e.g. pairing a phone) while driving.
- Some *Bluetooth*<sup>®</sup> Wireless Technology -enabled phones may not be recognized by the system or fully compatible with the system.
- Before using *Bluetooth*<sup>®</sup> Wireless Technology related features of the audio system, refer your phone's User's Manual for phone-side *Bluetooth*<sup>®</sup> Wireless Technology operations.
- The phone must be paired to the audio system to use *Bluetooth*<sup>®</sup> Wireless Technology related features.
- You will not be able to use the hands-free feature when your phone (in the car) is outside of the cellular service area (e.g. in a tunnel, in a underground, in a mountainous area, etc.).

(Continued)

(Continued)

- If the cellular phone signal is poor or the vehicles interior noise is too loud, it may be difficult to hear the other person's voice during a call.
- Do not place the phone near or inside metallic objects, otherwise communications with *Bluetooth*<sup>®</sup> Wireless Technology system or cellular service stations can be disturbed.
- While a phone is connected through *Bluetooth*<sup>®</sup> Wireless Technology your phone may discharge quicker than usual for additional *Bluetooth*<sup>®</sup> Wireless Technology-related operations.
- Some cellular phones or other devices may cause interference noise or malfunction to audio system. In this case, store the device in a different location may resolve the condition.
- Phone contact names should be saved in English or they may not be displayed correctly.

(Continued)

(Continued)

- If Priority is set upon vehicle ignition(IGN/ACC ON), the *Bluetooth*<sup>®</sup> Wireless Technology phone will be automatically connected.

Even if you are outside, the *Bluetooth*<sup>®</sup> Wireless Technology phone will be automatically connected once you are in the vicinity of the vehicle.

If you do not want automatic *Bluetooth*<sup>®</sup> Wireless Technology connection, turn the *Bluetooth*<sup>®</sup> Wireless Technology feature off.

- The hands-free call volume and quality may differ depending on the mobile phone type.
- *Bluetooth*<sup>®</sup> Wireless Technology features can be used only when the mobile phone has been paired and connected with the device. For more information on pairing and connecting *Bluetooth*<sup>®</sup> Wireless Technology enabled mobile phones, refer to the "Phone Setup" section.

(Continued)

(Continued)

- When a *Bluetooth*<sup>®</sup> Wireless Technology mobile phone is connected, a (📶) icon will appear at the top of the screen. If a (📶) icon is not displayed, this indicates that a *Bluetooth*<sup>®</sup> Wireless Technology enabled device has not been connected. You must connect the device before use. For more information on *Bluetooth*<sup>®</sup> Wireless Technology mobile phones, refer to the “Phone Setup” section.
- Pairing and connecting a *Bluetooth*<sup>®</sup> Wireless Technology enabled mobile phone will work only when the *Bluetooth*<sup>®</sup> Wireless Technology option within your mobile phone has been turned on. (Methods of turning on the *Bluetooth*<sup>®</sup> Wireless Technology enabled feature may differ depending on the mobile phone.)

(Continued)

(Continued)

- In some mobile phones, starting the ignition while talking through *Bluetooth*<sup>®</sup> Wireless Technology enabled handsfree call will result in the call becoming disconnected. (Switch the call back to your mobile phone when starting the ignition.)
- Some features may not be supported in some *Bluetooth*<sup>®</sup> Wireless Technology mobile phone and devices.
- *Bluetooth*<sup>®</sup> Wireless Technology enabled operation may be unstable depending on the communication state.
- Placing the audio system within an electromagnetic environment may result in noise interference.

**\* NOTICE - USING VOICE COMMAND**

- The voice recognition feature of this product supports recognition of the commands listed within this user's manual.
- While using voice recognition, operating the steering remote control or the device will terminate voice recognition and allow you to manually operate desired functions.
- Position the microphone above the head of the driver's seat. For superior performance, maintain good posture when saying voice commands.



(Continued)

(Continued)

- Voice recognition may not function properly due to outside noise. The following conditions can affect the performance of Voice Recognition:
  - When the windows and sunroof are open
  - When the heating/cooling system is on
  - When passing a tunnel
  - When driving on rugged and uneven roads
- After downloading *Bluetooth*® Wireless Technology phone book, the system requires some times to convert the phone book into voice information. During this time, voice recognition may not operate properly.
- Upon inputting your phone book, special symbols and numbers cannot be recognized by voice. For example, “# John Doe%&” will be recognized as “John Doe”.

## VOICE COMMAND (if equipped)

### Starting Voice Command

- To start voice command, shortly press the  key on the steering wheel remote controller.
- If voice command is in [Normal Mode], then the system will say “Please say a command. Beep”
- \* If voice command is in [Expert Mode], then the system will only say a “Beep-”
- \* Setting Voice command [Normal Mode]/[Expert Mode]:  
Press the **SETUP** key ▶ Select [System] through the  TUNE knob or **5** key ▶ Select [Voice Command Mode] through the  TUNE knob ▶ Set [Normal Mode]/[Expert Mode]
- Say the voice command.

### \* NOTICE

For proper voice recognition, say the voice command after the guidance message and the “Beep” sound.

### Skipping the Guidance Message

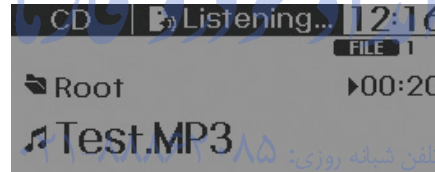

While the guidance message is being stated, shortly press the  key (under 0.8 seconds) to discontinue the guidance message and sound the “beep”.

After the “beep”, say the voice command.



FarmaSOS.com

### Ending Voice Command

- While using voice command, press and hold the  key (over 0.8 seconds) to end voice command.
- While using voice command, pressing the steering wheel remote controller or a different key will end voice command.
- In a state where the system is waiting for your voice command, say “cancel” or “end” to end voice command.
- In a state where the system is waiting for your voice command, shortly press the  key (under 0.8 seconds) to end voice command.

## \* Illustration on using voice commands

### • Starting voice command.

Shortly pressing the  key (under 0.8 seconds):

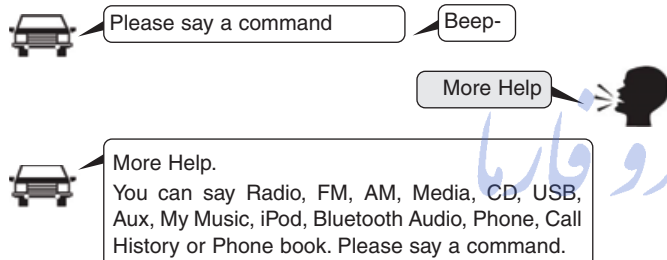

### • Skipping Voice Recognition

Shortly pressing the  key (under 0.8 seconds):

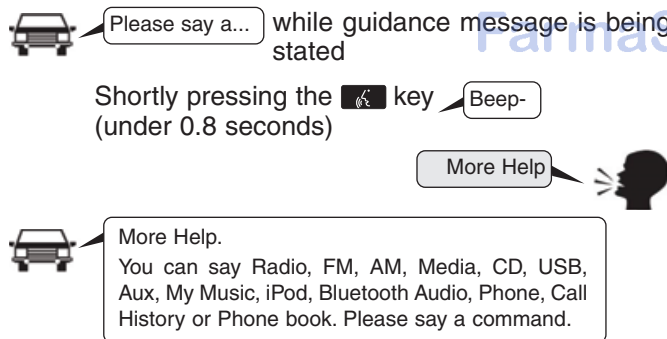

### • End voice command.

Shortly pressing the  key (under 0.8 seconds):

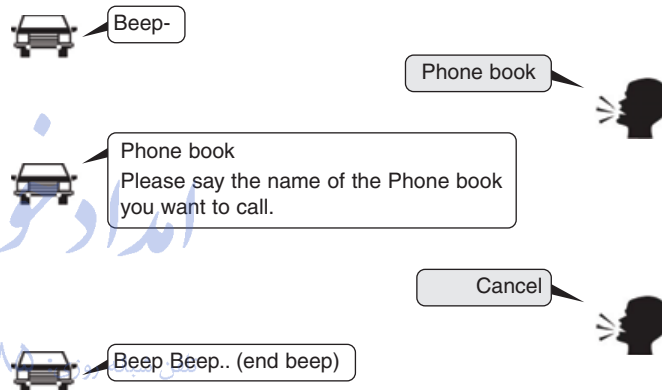

## Voice Command List

- **Common Commands:** These are commands that can be used in all situations. (However, some commands may not be supported in special circumstances.)

Command	Function
More Help	Provides guidance on commands that can be used anywhere in the system.
Help	Provides guidance on commands that can be used within the current mode.
Call<Name>	Calls <Name> saved in phone book Ex) Call "John"
Phone	Provides guidance on Phone related commands. After saying this command, say "Call History", "Phone book", "Dial Number" to execute corresponding functions.
Call History	Displays the Call History screen.
Phone book	Displays the phone book screen. After saying this command, say the name of a phone book saved in the phone book to automatically connect the call.
Dial Number	Display the Dial number screen. After saying this command, you can say the number what you want to call.
Redial	Connects the most recently called number.
Radio	<ul style="list-style-type: none"> <li>• When listening to the radio, displays the next radio screen. (FM1→FM2→FMA→AM→AMA)</li> <li>• When listening to a different mode, displays the most recently played radio screen.</li> </ul>

Command	Function
FM	<ul style="list-style-type: none"> <li>• When currently listening to the FM radio, maintains the current state.</li> <li>• When listening to a different mode, displays the most recently played FM screen.</li> </ul>
FM1(FM One)	Displays the FM1 screen.
FM2(FM Two)	Displays the FM2 screen.
FMA	Displays the FMA screen.
AM	Displays the AM screen.
AMA	Displays the AMA screen.
FM Preset 1~6	Plays the most recently played broadcast saved in FM Preset 1~6.
AM Preset 1~6	Plays the broadcast saved in AM Preset 1~6.
FM 87.5~107.9	Plays the FM broadcast of the corresponding frequency.
AM 530~1710	Plays the AM broadcast of the corresponding frequency.
TA on	Enable Traffic Announcement
TA off	Disable Traffic Announcement
News on	Enable RDS News feature
News off	Disable RDS News feature

Command	Function
Media	Moves to the most recently played media screen.
Play Track 1~30	If a music CD has been inserted, plays the corresponding track.
CD	Plays the music saved in the CD.
Search CD	Moves to the CD track or file selection screen. <ul style="list-style-type: none"> <li>• For audio CDs, move to the screen and say the track number to play the corresponding track.</li> <li>• Moves to MP3 CD file selection screen. After manually operate the device to select and play music.</li> </ul>
USB	Plays USB music.
Search USB	Moves to USB file selection screen. After manually operate the device to select and play music.
iPod	Plays iPod music.
Search iPod	Moves to the iPod file selection screen. After, manually operate the device to select and play music.
My Music	Plays the music saved in My Music.
Search My Music	Moves to My Music file selection screen. After manually operate the device to select and play music.

Command	Function
AUX (Auxiliary)	Plays the connected external device.
Bluetooth Audio	Plays the music saved in connected <i>Bluetooth®</i> Wireless Technology device.
Mute	Mutes the radio or music volume.
Pardon?	Repeats the most recent comment.
Cancel (Exit)	Ends voice command.

امداد خودروسازان

تلفن شبانه روزی: ۰۲۱-۸۸۸۶۲۰۸۵

ParmaSOS.com

- **FM/AM radio commands:** Commands that can be used while listening to FM, AM radio.

Command	Function
Preset 1~6	Plays the broadcast saved in Preset 1~6.
Auto Store	Automatically selects radio broadcast frequencies with superior reception and saves in Presets 1~6.
Preset Save 1~6	Saves the current broadcast frequency to Preset 1~6.
Seek up	Plays the next receivable broadcast.
Seek down	Plays the previous receivable broadcast.
Next Preset	Selects the preset number next to the most recently selected preset. (Example: When currently listening to preset no. 3, then preset no. 4 will be selected.)
Previous Preset	Selects the preset number previous to the most recently selected preset. (Example: When currently listening to preset no. 3, then preset no. 2 will be selected.)
Scan	Scans receivable frequencies from the current broadcast and plays for 10 seconds each.
Preset Scan	Moves to the next preset from the current present and plays for 10 seconds each.
AF on	Enable Alternative Frequency feature
AF off	Disable Alternative Frequency feature
Region	Enable Region feature

- **Audio CD commands:** Commands that can be used while listening to Audio CD.

Command	Function
Region off	Disable Region feature
Program Type	Moves to the RDS Program type selection screen. After, manually operate the device to select a desired program type.
Random	Randomly plays the tracks within the CD.
Random Off	Cancels random play to play tracks in sequential order.
Repeat	Repeats the current track.
Repeat Off	Cancels repeat play to play tracks in sequential order.
Next Track	Plays the next track.
Previous Track	Plays the previous track.
Scan	Scans the tracks from the next track for 10 seconds each.
Track 1~30	Plays the desired track number.
Search Track	Moves to the track selection screen. After, say the track name to play the corresponding track.
Information	Displays the information screen of the current track.



- **MP3 CD / USB commands:** Commands that can be used while listening to music files saved in CD and USB.

Command	Function
Random	Randomly plays the files within the current folder.
All Random	Randomly plays all saved files.
Random Off	Cancels random play to play files in sequential order.
Repeat	Repeats the current file.
Folder Repeat	Repeats all files in the current folder.
Repeat Off	Cancels repeat play to play files in sequential order.
Next File	Plays the next file.
Previous File	Plays the previous file.
Scan	Scans the files from the next files for 10 seconds each.
Search File	Moves to the file selection screen.
Search Folder	Moves to the folder selection screen.
Information	Displays the information screen of the current file.
Copy	Copies the current file into My Music.

- **iPod Commands:** Commands that can be used while playing iPod.

Command	Function
All Random	Randomly plays all saved songs.
Random	Randomly plays the songs within the current category.
Random Off	Cancels random play to play songs in sequential order.
Repeat	Repeats the current song.
Repeat Off	Cancels repeat play to play songs in sequential order.
Next Song	Plays the next song.
Previous Song	Plays the previous song.
Search Song	Moves to the song selection screen.
Information	Displays the information screen of the current song.

- **My Music Commands:** Commands that can be used while playing My Music.

Command	Function
Random	Randomly plays all saved files.
Random Off	Cancels random play to play files in sequential order.
Repeat	Repeats the current file.
Repeat Off	Cancels repeat play to play files in sequential order.
Next File	Plays the next file.
Previous File	Plays the previous file.
Scan	Scans the files from the next files for 10 seconds each.
Search File	Moves to the file selection screen.
Information	Displays the information screen of the current file.
Delete	Deletes the current file. You will bypass an additional confirmation process.
Delete All	Deletes all files saved in My Music. You will bypass an additional confirmation process.

- **Bluetooth® Wireless Technology Audio Commands:** Commands that can be used while playing Phone Music.

Command	Function
Play	Plays the currently paused song.
Pause	Pauses the current song.

امداد خودرو فاریا

تلفن شبانه روزی: ۰۸۵-۸۸۸۶۲۰۲۱

www.SOS.com

## APPENDIX

Name	Description
AST (A.store)	Automatically selects and saves channels
SDVC	Speed Dependent Volume Control

امداد خودرو فارما

تلفن شبانه روزی: ۰۲۱-۸۸۸۶۲۰۸۵

FarmaSOS.com

■ CD Player (for RDS model) : AM904DMEE, AM914DMEE



\*No  Bluetooth logo will be shown if the *Bluetooth*<sup>®</sup> Wireless Technology feature is not supported.

## SYSTEM CONTROLLERS AND FUNCTIONS

\* Display and settings may differ depending on the selected audio.

### Audio Head Unit (for RDS, *Bluetooth*® Wireless Technology equipped model)



1. **EJECT** (EJECT)

- Ejects the disc.

2. **RADIO**

- Converts to Radio(FM/AM) mode.
- Each time the key is pressed,the mode is changed in order of FM1 → FM2 → FMA → AM → AMA.

3. **MEDIA**

- Start Media mode
- Each time the key is pressed, the mode is changed in order of CD, USB(iPod) AUX, My Music, BT Audio.

4. **PHONE** (for *Bluetooth*® Wireless Technology equipped model)

- Converts to Phone mode

\* When a phone is not connected, the connection screen is displayed.

5. PWR/VOL knob

- **Power** : Press to turn power on/off.
- **Volume** : Turn left/right to control volume.

6. **SEEK TRACK**

- When pressed shortly(under 0.8 seconds)
  - Radio mode : plays previous/next frequency.
  - Media (CD/USB/iPod/My Music) modes : changes the track, Song(file)
- When pressed and held (0.8 seconds)
  - Radio mode : continuously changes the frequency. Upon release, plays the current frequency.
  - Media(CD/USB/iPod/My Music) modes : rewinds or fast forwards the track or file
  - During a Handsfree call, controls the call volume.

7. **PTY FOLDER**

- RDS Radio mode : searches RDS program types.
- CD/USB/MP3 modes : searches folders.



8. 

- Turns the monitor display on/off.

9. CLOCK

- Displays the time/date/day.

10. **TA/SCAN**

- Radio Mode :
  - Short key : TA On/Off
  - Long key : previews all receivable broadcasts for 5 seconds each.
- Media (CD/USB/iPod/My Music) modes : previews each song (file) for 10 seconds each.

11. **SETUP**

- Converts to Setup mode.

12.  TUNE knob

- Radio mode : turn to change broadcast frequencies.
- Media (CD/USB/iPod/My Music) modes : turn to search tracks/channels/files.



13. DISC-IN LED

- LED that indicates whether a disc is inserted.

14. RESET

- Forced system termination and system restart.

### Audio Head Unit



#### 15. **FM**

- Changes to FM mode.
- Each time the key is pressed, the mode changed in order of FM1 → FM2 → FMA.

#### 16. **AM**

- Changes to AM mode.
- Each time the key is pressed, the mode changed in order of AM → AMA.

#### 17. **MEDIA**

- Start Media mode
- Each time the key is pressed, the mode is changed in order of CD, USB(iPod), AUX, My Music.

امداد خودرو فارما

تلفن شبانه روزی: ۰۲۱-۸۸۸۶۲۰۸۵

[FarmaSOS.com](http://FarmaSOS.com)

- CD Player : AM900DMMG, AM910DMMG, AM911DMMG, AM901DMGG, AM910DMEE, AM911DMEE, AM912DMEE, AM913DMEE, AM910DMGL, AM911DMGL\*, AM900DMMN, AM910DMMN



\* : for columbia

✳ No  Bluetooth logo will be shown if the *Bluetooth*<sup>®</sup> Wireless Technology feature is not supported.



### SYSTEM CONTROLLERS AND FUNCTIONS

\* Display and settings may differ depending on the selected audio.

#### Audio Head Unit (for *Bluetooth*® Wireless Technology equipped model)



1. **EJECT** (EJECT)

- Ejects the disc.

2. **RADIO**

- Converts to Radio(FM/AM) mode.
- Each time the key is pressed, the mode is changed in order of FM1→FM2→AM.

3. **MEDIA**

- Start Media mode
- Each time the key is pressed, the mode is changed in order of CD, USB(iPod) AUX, My Music, BT Audio.

4. **PHONE** (for *Bluetooth*® Wireless  
Technology equipped model)

- Converts to Phone mode
- \* When a phone is not connected, the connection screen is displayed.

5. PWR/VOL knob

- **Power** : Press to turn power on/off.
- **Volume** : Turn left/right to control volume.

6. **SEEK TRACK**

- When pressed shortly (under 0.8 seconds)
  - Radio mode : plays previous/next frequency.
  - Media (CD/USB/iPod/My Music) modes : changes the track, Song(file)
- When pressed and held (0.8 seconds)
  - Radio mode : continuously changes the frequency. Upon release, plays the current frequency.
  - Media(CD/USB/iPod/My Music) modes : rewinds or fast forwards the track or file
  - During a Handsfree call, controls the call volume.

7. **FOLDER**

- CD/USB/MP3 modes : searches folders.



8. **DISP**

- Turns the monitor display on/off.

9. **CLOCK**

Displays the time/date/day.

10. **SCAN**

- Radio Mode : previews all receivable broadcasts for 5 seconds each
- Media (CD/USB/iPod/My Music) modes : previews each song (file) for 10 seconds each.

11. **SETUP**

Converts to Setup mode.

12. **TUNE knob**

- Radio mode : turn to change broadcast frequencies.
- Media (CD/USB/iPod/My Music) modes : turn to search tracks/channels/files.



13. **DISC-IN LED**

- LED that indicates whether a disc is inserted.

14. **RESET**

- Forced system termination and system restart.

## Audio Head Unit



15. **FM**

- Converts to FM mode.
- Each time the key is pressed, the mode changed in order of FM1 → FM2.

16. **AM**

- Converts to AM mode.

17. **MEDIA**

- Start Media mode
- Each time the key is pressed, the mode is changed in order of CD, USB(iPod), AUX, My Music.

### Steering remote controller



#### 1. VOLUME

- Used to control volume.

#### 2. MUTE

- Mutes audio volume.

#### 3. SEEK

- When pressed shortly (under 0.8 seconds)
  - Radio mode : searches broadcast frequencies saved to presets.
  - Media (CD/USB/iPod/My Music/ BT Audio) modes : changes the track, file or chapter.
- When pressed and held (over 0.8 seconds)
  - Radio mode, automatically searches broadcast frequencies and channels
  - Media (CD/USB/iPod/My Music) modes, rewinds or fast forwards the track or song (file)
  - BT Audio mode may not be supported in some mobile phones.

#### 4. MODE

- Each time this key is pressed, the mode is changed in order of FM1 → FM2 → FMA → AM → AMA → USB or iPod → AUX → My Music → BT Audio
- If the media is not connected or a disc is not inserted, corresponding modes will be disabled.

#### 5. (if equipped)

- When pressed shortly (under 0.8 seconds)
  - Starts voice recognition
  - When selecting during a voice prompt, stops the prompt and converts to voice command waiting state
- When pressed and held (over 0.8 seconds)
  - Ends voice recognition

6. 

- When pressed shortly (under 0.8 seconds)
  - When pressed in the phone screen, displays call history screen
  - When pressed in the dial screen, makes a call
  - When pressed in the incoming call screen, answers the call
  - When pressed during call waiting, switches to waiting call (Call Waiting)
- When pressed and held (over 0.8 seconds)
  - When pressed in the *Bluetooth*<sup>®</sup> Wireless Technology Handsfree wait mode, redials the last call
  - When pressed during a *Bluetooth*<sup>®</sup> Wireless Technology Handsfree call, switches call back to mobile phone (Private)
  - When pressed while calling on the mobile phone, switches call back to *Bluetooth*<sup>®</sup> Wireless Technology Handsfree (Operates only when *Bluetooth*<sup>®</sup> Wireless Technology Handsfree is connected)

7. 

- Ends phone call

امداد خودرو فارما

تلفن شبانه روزی: ۰۲۱-۸۸۸۶۲۰۸۵

FarmaSOS.com

## Radio Mode (for RDS model) - AM904DMEE, AM914DMEE

### Basic Mode Screen



1. Mode Display  
Displays currently operating mode

2. Frequency  
Displays the current frequency

3. Preset  
Displays current preset number [1] ~ [6]

4. Preset Display  
Displays saved presets

5. Autostore  
Automatically saves frequencies with superior reception to Preset buttons

6. RDS Menu  
Displays the RDS Menu

7. RDS Info  
Displays RDS broadcast information

### Switching to Radio Mode

Pressing the **RADIO** key will change the operating mode in order of FM1 → FM2 → FMA → AM → AMA.

Pressing the **FM** or **AM** key to change the operating mode in order of FM1 → FM2 → FMA and AM → AMA.

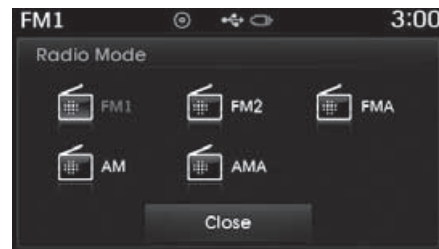

If [Pop-up Mode] is turned on within **SETUP** ▶ [Display], then pressing the **RADIO** key will display the Radio Pop-up Mode screen.

Turn the **TUNE** knob to move the focus. Press the knob to select.

## Searching Radio Frequencies

### Using Seek

Press the  key to play the previous/next frequency.



### Using TUNE

Turn the  knob to select the desired frequency.

- FM : Increases/decreased by 50kHz
- AM : Increases/decreased by 9kHz

## Using Radio Mode

### Selecting/Saving Presets

Press the  ~  buttons to play the desired preset.

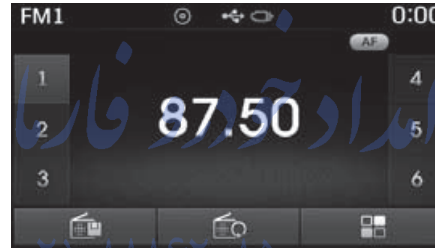

Press the  button to display the broadcast information for the frequency saved to each button.



## \* NOTICE

While listening to a frequency you want to save as a preset, press and hold one of the [1] ~ [6] preset buttons (over 0.8 seconds) to save the current frequency to the selected preset.

### Auto Store

Press the  button to automatically save receivable frequencies to Preset buttons.

## \* NOTICE

While Auto Store is operating, pressing the [Cancel] button again will cancel Auto Store and restore the previous frequency.

### **RDS Menu**

Press the  button to set the AF (Alternative Frequency), Region and News features.

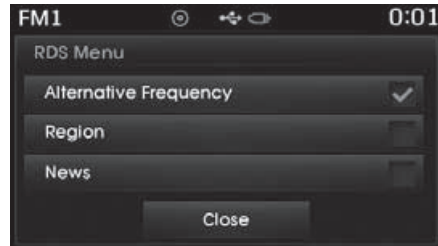

### **\* NOTICE**

The RDS Menu is not supported within AM or AMA mode.

### **Scan**

Press and hold the  key (over 0.8 seconds) to preview frequencies with superior reception for 5 seconds each.

### **\* NOTICE**

Once scan is complete, the previous frequency will be restored. While Scan is operating, pressing and holding the  key (over 0.8 seconds) will cancel the scan operation.

تلفن شبانه روزی: ۰۲۱-۸۸۸۶۲۰۸۵

[FarmaSOS.com](http://FarmaSOS.com)

## Program Type

Press the **PTY FOLDER** key to search for the desired Program type.

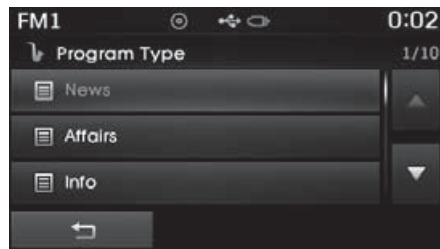

Turn the **TUNE** knob left/right to search for the desired program type. Once you find the desired program type, press the **TUNE** knob.

After selecting the desired Program Type and while the Program Type is blinking (approximately 5 seconds), pressing the **SEEK TRACK** key will allow you to select a different Program Type broadcast.

## TA (Traffic Announcement)

Press the **TA/SCAN** key to turn the TA (Traffic Announcement) feature On/Off.

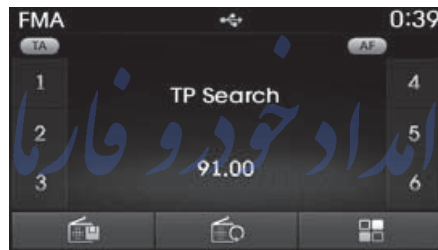

تلفن شبانه روزی: ۰۲۱-۸۸۸۶۲۰۸۵

[FarmaSOS.com](http://FarmaSOS.com)



## RADIO MODE

- AM900DMMG, AM910DMMG,  
AM911DMMG, AM901DMGG,  
AM910DMEE, AM911DMEE,  
AM912DMEE, AM913DMEE,  
AM910DMGL, AM911DMGL,  
AM900DMMN, AM910DMMN

### Basic Mode Screen



### 1. Mode Display

Displays currently operating mode

### 2. Frequency

Displays the current frequency

### 3. Preset

Displays current preset number [1] ~ [6]

### 4. Preset Display

Displays preset buttons

### 5. Autostore

Automatically saves frequencies with superior reception to Preset buttons

## Switching to Radio Mode

Pressing the **RADIO** key will change the operating mode in order of FM1 → FM2 → AM

Press the **FM** or **AM** key to change the mode in order of FM1 → FM2 and AM.

If [Mode Pop-up] is turned on within **SETUP** ▶ [Display], then pressing the **RADIO** key will display the Radio Pop-up Mode screen.



Turn the **TUNE** knob to move the focus. Press the knob to select.

## Searching Radio Frequencies

### Using Seek

Press the  key to play the previous/next frequency.

### Using TUNE

Turn the  knob to select the desired frequency.

- FM : Increases/decreased by 100kHz
- AM : Increases/decreased by 9kHz

## Using Radio Mode

### Selecting /Saving Presets

Press the  button to display the broadcast information for the frequency saved to each button.



Press the  ~  buttons to play the desired preset.

FarmasOS.com

### \* NOTICE

While listening to a frequency you want to save as a preset, press and hold one of the [1] ~ [6] preset buttons (over 0.8 seconds) to save the current frequency to the selected preset.

### Auto Store

Press the  button to automatically save receivable frequencies to Preset buttons.

### Scan

Press the  key to preview frequencies with superior reception for 5 seconds each.

Press and hold the  key (over 0.8 seconds) to preview presets for 5 seconds each.

### \* NOTICE

- Once scan is complete, the previous frequency will be restored.
- While Scan is operating, pressing the  key will cancel the scan operation.

### \* NOTICE - USING THE DISCS

- This device has been manufactured to be compatible with software bearing the following logo marks.
- Do not clean discs with chemical solutions, such as record sprays, antistatic sprays, antistatic liquids, benzene, or thinners.
- After using a disc, put the disc back in its original case to prevent disc scratches.
- Hold discs by their edges or within the center hole to prevent damages to disc surfaces.
- Do not introduce foreign substances into the disc insert/eject slot. Introducing foreign substances could damage the device interior.
- Do not insert two discs simultaneously.
- When using CD-R/CD-RW discs, differences in disc reading and playing times may occur depending on the disc manufacturer, production method and the recording method as used by the user.

(Continued)

(Continued)

- Clean fingerprints and dust off the disc surface (coated side) with a soft cloth.
- The use of CD-R/CD-RW discs attached with labels may result in disc slot jams or difficulties in disc removal. Such discs may also result in noise while playing.
- Some CD-R/CD-RW discs may not properly operate depending on the disc manufacturer, production method and the record method as used by the user. If problems persist, trying using a different CD as continued use may result in malfunctions.
- The performance of this product may differ depending on the CD-RW Drive Software.
- Copy-protected CDs such as S-type CDs may not function in the device. DATA discs cannot be played. (However, such discs may still operate but will do so abnormally.)

(Continued)

(Continued)

- Do not use abnormally shaped discs (8cm, heart-shaped, octagon-shaped) as such discs could lead to malfunctions.
- If the disc is straddled on the disc slot without removal for 10 seconds, the disc will automatically be re-inserted into the disc player.
- Only genuine audio CDs are supported. Other discs may result in recognition failure (e.g. copy CD-R, CDs with labels)

## MP3 File Information

### • Supported Audio Formats

File System	ISO 9660 Level 1
	ISO 9660 Level 2
	Romeo / Juliet (128 characters)
Audio Compression	MPEG1 Audio Layer3
	MPEG2 Audio Layer3
	MPEG2.5 Audio Layer3
	Windows Media Audio Ver 7.X & 8.X

\* File formats that do not comply with the above formats may not be properly recognized or play without properly displaying file names or other information.

### • Support for Compressed Files

#### 1. Supported Bitrates (Kbps)

	MPEG1	MPEG2	MPEG2.5	WMA
	Layer3	Layer3	Layer3	High Range
	32	8	8	48
	40	16	16	64
	48	24	24	80
	56	32	32	96
	64	40	40	128
	80	48	48	160
	96	56	56	192
	112	64	64	
	128	80	80	
	160	96	96	
	192	112	112	
	224	128	128	
	256	144	144	
	320	160	160	

#### 2. Sampling Frequencies (Hz)

MPEG1	MPEG2	MPEG2.5	WMA
44100	22050	11025	32000
48000	24000	12000	44100
3000	16000	8000	48000

• For MP3/WMA compression files, differences in sound quality will occur depending on the bitrate. (Higher sound quality can be experienced with higher bitrates.)

• This device only recognizes files with MP3/WMA extensions. Other file extensions may not be properly recognized.

3. Maximum number of recognized folders and files

- Folder : 255 folders for CD, 2,000 folders for USB

- File : 999 files for CD, 6,000 files for USB

\* There are no limitations to the number of recognized folder levels

### • Language Support (Unicode Support)

1. English: 94 characters
  2. Special characters and Symbols : 986 characters
- ✳ Languages other than Korean and English (including Chinese) are not included.
3. Text Display (Based on Unicode)
    - File name: Maximum 64 English characters
    - Folder name: Max 32 English characters
- ✳ Using the scroll feature allows you to see the entire name of files with names that are too long to be displayed at once.

### • Compatibility by Disc Type

1. Playing MIXED CDs: First plays the audio CD, then plays the compressed file(s).
2. Playing EXTRA CDs: First plays the audio CD, then plays the compressed file(s).
3. Playing multisession CDs: Plays in order of sessions
  - MIXED CD : CD type in which both MP3 and audio CD files are recognized in one disc.
  - Multisession CD CD type that includes more than two sessions. Different from Extra CDs, multisession CDs are recorded by sessions and have no media limitation.

### • Precautions upon Writing CDs

1. In all cases except when creating multisession discs, check the close session option before creating the disc. Though product malfunctions will not occur, some time may be required for the device to check whether the session state is closed (approximately 25 seconds). (Additional time may also be required depending on the number of folders or files.)
2. Changing the MP3/WMA file extensions or changing files of other extensions to MP3/WMA may result in product malfunction.
3. When naming files with MP3/WMA file extensions, write using only Korean and English. (Languages other than Korean and English are not supported and are displayed as blank.)
4. Unauthorized use or duplication of music files are prohibited by law.

5. Prolonged use of CD-R/CD-RW discs that do not satisfy related standards and/or specifications could result in product malfunction.
6. Unauthorized use or duplication of MP3/WMA files is prohibited by law.

امداد خودرو فارما

تلفن شبانه روزی: ۰۲۱-۸۸۸۶۲۰۸۵

FarmaSOS.com

## MEDIA MODE

- AM910DMMG, AM911DMMG, AM912DMEE, AM913DMEE, AM914DMEE, AM910DMMN, AM911DMGL

### Switching to Media Mode (for *Bluetooth®* Wireless Technology equipped model)

Pressing the **MEDIA** key will change the operating mode in order of CD → USB (iPod) → AUX → My Music → BT Audio.

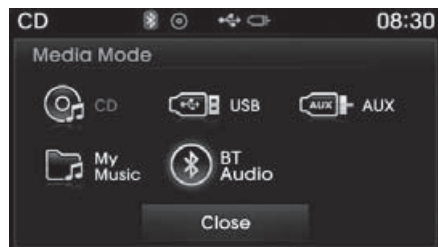

If [Pop-up Mode] / [Mode Pop-up] is turned on within **SETUP** ▶ [Display], then pressing the **MEDIA** key will display the Media Pop-up Mode screen. Turn the **TUNE** knob to move the focus. Press the knob to select.

## MEDIA MODE

- AM900DMMG, AM901DMMG, AM910DMEE, AM911DMEE, AM910DMGL, AM900DMMN, AM904DMEE

### Switching to Media Mode

Pressing the **MEDIA** key will change the operating mode in order of CD → USB (iPod) → AUX → My Music.



If [Pop-up Mode] / [Mode Pop-up] is turned on within **SETUP** ▶ [Display], then pressing the **MEDIA** key will display the Media Pop-up Mode screen.

Turn the **TUNE** knob to move the focus. Press the knob to select.

## \* NOTICE

The media mode pop up screen can be displayed only when there are two or more media modes turned on.

### Title Icon

When a *Bluetooth®* Wireless Technology, iPod, USB, or AUX device is connected or a CD is inserted, the corresponding mode icon will be displayed.



Icon	Title
	<i>Bluetooth®</i> Wireless Technology
	CD
	iPod
	USB
	AUX

## AUDIO CD MODE

### Basic Mode Screen



<for RDS model>



#### 1. Mode

Displays currently operating mode

#### 2. Operation State

From Repeat/Random(Shuffle)/Scan, displays the currently operating function

#### 3. Track Info

Displays information about the current track

#### 4. Play/Pause

Changes the play/pause state

#### 5. Play Time

Displays the current play time

#### 6. Info

Shows detailed information about the current track

#### 7. Random(Shuffle)

Turns the Random(Shuffle) feature on/off

#### 8. Repeat

Turns the Repeat feature on/off

#### 9. List

Moves to the list screen



### Using Audio CD Mode

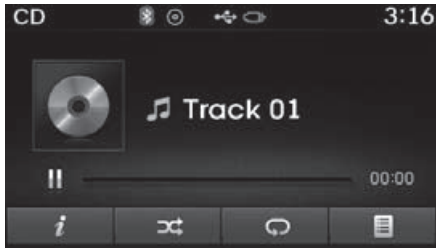

#### Playing/Pausing CD Tracks

Once an audio CD is inserted, the mode will automatically start and begin playing.



<for RDS model>



While playing, press the  button to pause and press  button to play.

### \* NOTICE

- Only genuine audio CDs are supported. Other discs may result in recognition failure (e.g. copy CD-R, CDs with labels)
- The artist and title information are displayed on the screen if track information is included within the audio CD.

امداد خودرو فارما



تلفن شبانه روزی: ۰۲۱-۸۸۸۶۲۰۸۵

FarmaSOS.com

### Changing Tracks

Press the  key to move to the previous or next track.

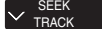
### \* NOTICE

- Pressing the  key after the track has been playing for 3 seconds will start the current track from the beginning.
- Pressing the  key before the track has been playing for 3 seconds will start the previous track.

### Selecting from the List

Turn the **TUNE** knob left/right to search for the desired track.

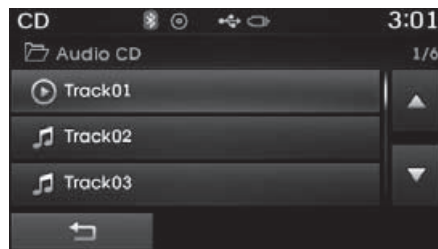

Once you find the desired track, press the **TUNE** knob to start playing.

### Rewinding / Fast-forwarding Tracks

While playing, press and hold the **SEEK TRACK** key (over 0.8 seconds) to rewind or fast-forward the current track.

### Scan(for RDS model)

Press and hold the **TA/SCAN** key (over 0.8 seconds) to play the first 10 seconds of each track.

### Scan

Press the **SCAN** key to play the first 10 seconds of each file.

### Audio CD Mode Menu

Within this mode, you will have access to the Info, Random(Shuffle), Repeat and List features.

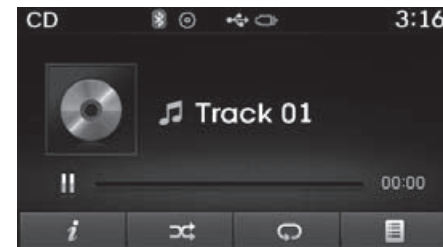

<for RDS model>

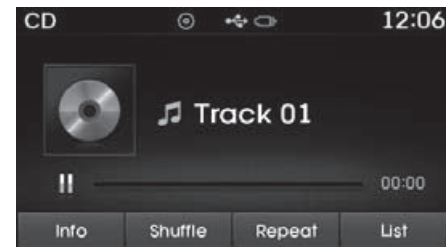

FarmaSOS.com

### **Info**

Press the  (Info) button to display details about the current disc.

### **Random(Shuffle)**

Press the  (Shuffle) button to play tracks in random(Shuffle) order.

Press the button again to turn the Random(Shuffle) feature off.

- Random(Shuffle): Plays all tracks in random(Shuffle) order.

### **Repeat**

Press the  (Repeat) button to repeat the current track. Press the button again to turn the repeat feature off.

- Repeat: Repeats the current track.

### **List**

Press the  (List) button to display the track list screen.

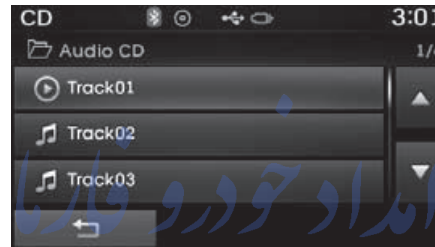

Turn the  TUNE knob left/right to search for tracks. Once the desired track is displayed, press the knob to select and play.

[FarmaSOS.com](http://FarmaSOS.com)

## MP3 CD MODE

### Basic Mode Screen

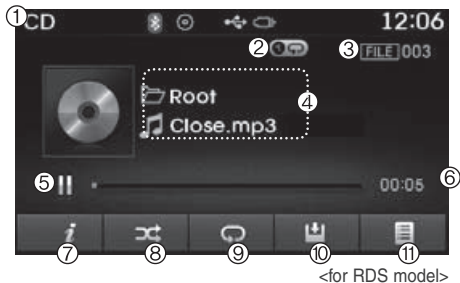

#### 1. Mode

Displays currently operating mode.

#### 2. Operation State

From Repeat/Random(Shuffle)/ Scan, displays the currently operating function

#### 3. File Index

Displays the current file number

#### 4. File Info

Displays information about the current file

#### 5. Play/Pause

Changes the play/pause state

#### 6. Play Time

Displays the current play time

#### 7. Info

Shows detailed information about the current file

#### 8. Random(Shuffle)

Turns the Random(Shuffle) feature on/off

#### 9. Repeat

Turns the Repeat feature on/off

#### 10. Copy

Copies the current file into My Music

#### 11. List

Moves to the list screen

## Using MP3 CD Mode

### Playing/Pausing MP3 Files

Once an MP3 disc is inserted the mode will automatically start and being playing.

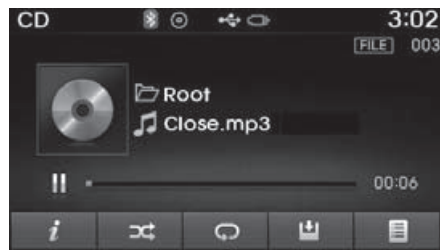

<for RDS model>

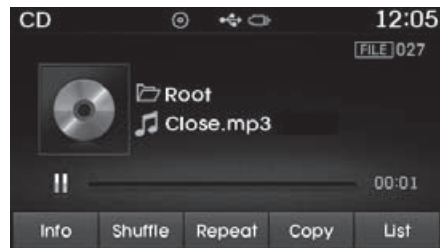

While playing, press the **||** button to pause and press **▶** button to play.

### \* NOTICE

If there are numerous files and folders within the disc, reading time could take more than 10 seconds and the list may not be displayed or song searches may not operate. Once loading is complete, try again.

### Changing Files

Press the **SEEK TRACK** key to move to the previous or next file.

### \* NOTICE

- Pressing the **SEEK TRACK** key after the file has been playing for 3 seconds will start the current file from the beginning.
- Pressing the **SEEK TRACK** key before the file has been playing for 3 seconds will start the previous file.

### Selecting from the List

Turn the **TUNE** knob left/right to search for the desired file.

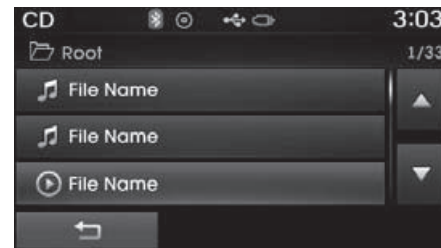

Once you find the desired file, press the **TUNE** knob to start playing.

### Rewinding / Fast-forwarding Files

While playing, press and hold the **SEEK TRACK** key (over 0.8 seconds) to rewind or fast-forward the current file.

### Scan(for RDS model)

Press and hold the **TA/SCAN** key (over 0.8 seconds) to play the first 10 seconds of each file.

### Scan

Press the **SCAN** key to play the first 10 seconds of each file.

### Searching Folders

Press the **PTY FOLDER** ( **∨ FOLDER ∨** ) key to select and search folders.

Once the desired folder is displayed, press the **TUNE** knob to select.

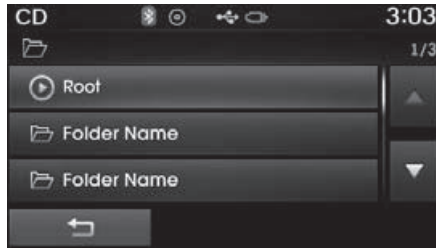

The first file within the selected folder will begin playing.

### MP3 CD Mode Menu

Within this mode, you will have access to the Info, Random(Shuffle), Repeat, Copy and List features.

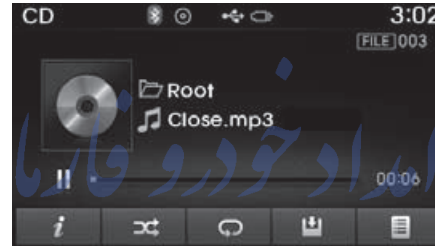

<for RDS model>

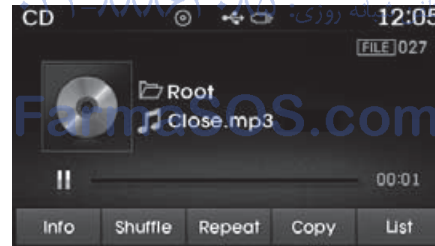

### Info

Press the **i** ( **Info** ) button to display details about the current file.

### \* NOTICE

- When the 'Folder File' option is set as the default display within Display setup, the album/artist/file information are displayed as detailed file information.
- When the 'Album Artist Song' option is set as the default display, the folder name/file name are displayed as detailed file information.
- The title, artist and album info are displayed only when such information are recorded within the MP3 file ID3 tag.

### **Random(Shuffle)**

Press the  (Shuffle) button to play files in random(Shuffle) order.

Each time the button is pressed, the feature changes in order of Random (Shuffle) Folder → Random (Shuffle) All → Off.

- Random(Shuffle) Folder : Plays all files within the current folder in Random (Shuffle) order.
- Random(Shuffle) All : Plays all files in Random(Shuffle) order.

### **Repeat**

Press the  (Repeat) button to repeat the current file or folder.

Each time the button is pressed, the feature changes in order of Repeat → Repeat Folder → Off.

- Repeat: Repeats the current file.
- Repeat Folder: Repeats all files within the current Folder.

### **Copying Files**

Press the  (Copy) button to copy the current file into My Music.

### **\* NOTICE**

Selecting another feature during copying will display a pop-up asking whether you wish to cancel copying. To cancel, select 'Yes'.

امداد خودرو فارما

تلفن شبانه روزی: ۰۲۱-۸۸۸۶۲۰۸۵

FarmaSOS.com

### **List**

Press the  (List) button to display the file list screen.

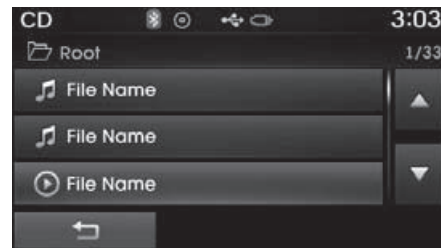

Turn the  TUNE knob left/right to search for files. Once the desired file is displayed, press the knob to select and play.

## \* NOTICE - USING THE USB DEVICE

- Connect the USB device after turning on the engine. The USB device may become damaged if it is already connected when the ignition is turned on. The USB device may not operate properly if the car ignition is turned on or off with the USB device connected.
- Heed caution to static electricity when connecting/disconnecting USB devices.
- Encoded MP3 Players will not be recognized when connected as an external device.
- When connecting an external USB device, the device may not properly recognize the USB is in some states.
- Only products formatted with byte/sectors under 64Kbyte will be recognized.
- This device recognizes USB devices formatted in FAT 12/16/32 file formats. This device does not recognize files in NTFS file format.

(Continued)

(Continued)

- Some USB devices may not be supported due to compatibility issues.
- Avoid contact between the USB connector with bodily parts or foreign objects.
- Repeated connecting/disconnecting of USB devices within short periods of time may result in product malfunction.
- A strange noise may occur when disconnecting the USB.
- Make sure to connect/disconnect external USB devices with the audio power turned off.
- The amount of time required to recognize the USB device may differ depending on the type, size or file formats stored in the USB. Such differences in time are not indications of malfunctions.
- The device only supports USB devices used to play music files.
- USB images and videos are not supported.

(Continued)

(Continued)

- Do not use the USB I/F to charge batteries or USB accessories that generate heat. Such acts may lead to worsened performance or damage to the device.
- The device may not recognize the USB device if separately purchased USB hubs and extension cables are being used. Connect the USB directly with the multimedia terminal of the vehicle.
- When using mass storage USB devices with separate logical drives, only files saved to the root drive can be played.
- Files may not properly operate if application programs are installed to the USBs.
- The device may not operate normally if MP3 Players, cellular phones, digital cameras, or other electronic devices (USB devices not recognized as portable disk drives) are connected with the device.

(Continued)



(Continued)

- Charging through the USB may not work for some mobile devices.
- The device may not support normal operation when using a USB memory type besides (Metal Cover Type) USB Memory.
- The device may not support normal operation when using formats such as HDD Type, CF, or SD Memory.
- The device will not support files locked by DRM (Digital Rights Management.)
- USB memory sticks used by connecting an Adaptor (SD Type or CF Type) may not be properly recognized.
- The device may not operate properly when using USB HDDs or USBs subject to connection failures caused by vehicle vibrations. (e.g. i-stick type)

(Continued)

(Continued)

- Avoid use of USB memory products that can also be used as key chains or mobile phone accessories. Use of such products may cause damage to the USB jack.
- Connecting an MP3 device or phone through various channels, such as AUX/BT or Audio/USB mode may result in pop noises or abnormal operation.



تلفن شبانه روزی: ۰۲۱-۸۸۸۶۲۰۸۵

FarmaSOS.com

## USB MODE

### Basic Mode Screen

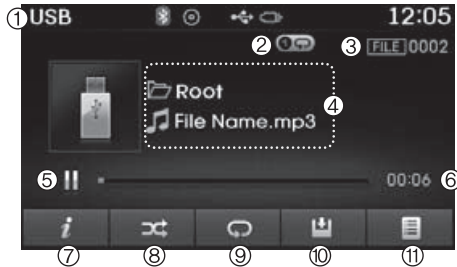

<for RDS model>

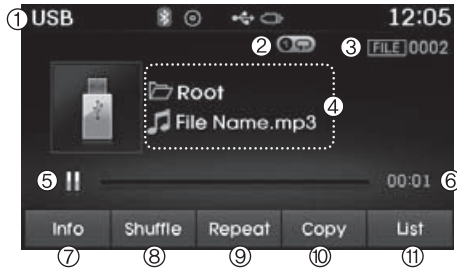

#### 1. Mode

Displays currently operating mode

#### 2. Operation State

From Repeat/Random(Shuffle)/ Scan, displays the currently operating function

#### 3. File Index

Displays the current file number

#### 4. File Info

Displays information about the current file

#### 5. Play/Pause

Changes the play/pause state

#### 6. Play Time

Displays the current play time

#### 7. Info

Displays detailed information for the current file

#### 8. Random(Shuffle)

Turns the Random(Shuffle) feature on/off

#### 9. Repeat

Turns the Repeat feature on/off

#### 10. Copy

Copies the current file into My Music

#### 11. List

Moves to the list screen

### Using USB Mode

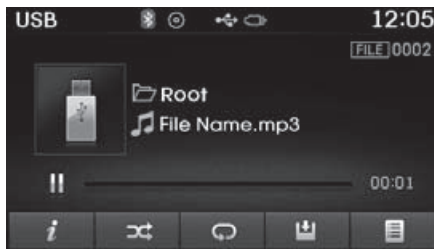

#### Playing/Pausing USB Files

Once a USB is connected, the mode will automatically start and begin playing a USB file.

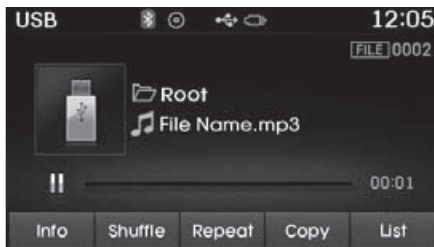

<for RDS model>



While playing, press the  button to pause and press  button to play.

### \* NOTICE

- Loading may require additional time if there are many files and folders within the USB and result in faulty list display or file searching. Normal operations will resume once loading is complete.
- The device may not support normal operation when using a USB memory type besides (Metal Cover Type) USB Memory.



تلفن شبانه روزی: ۰۲۱-۸۸۸۶۲۰۸۵

FarmaSOS.com

### Changing Files

Press the  keys to move to the previous or next file.

### \* NOTICE

- Pressing the  key after the file has been playing for 3 seconds will start the current file from the beginning.
- Pressing the  key before the file has been playing for 3 seconds will start the previous file.

### Selecting from the List

Turn the **TUNE** knob left/right to search for the desired file.

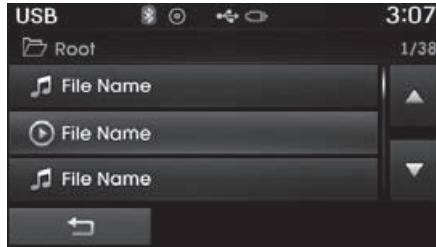

Once you find the desired file, press the **TUNE** knob to start playing.

### Rewinding / Fast-forwarding Files

While playing, press and hold the **SEEK TRACK** key (over 0.8 seconds) to rewind or fast-forward the current file.

### Scan(for RDS model)

Press and hold the **TA/SCAN** key (over 0.8 seconds) to play the first 10 seconds of each file.

### Scan

Press the **SCAN** key to play the first 10 seconds of each file.

تلفن شبانه روزی: ۰۲۱-۸۸۸۶۲۰۸۵

FarmaSOS.com

### Searching Folders

Press the **PTY FOLDER** (**FOLDER**) key to select and search folders.

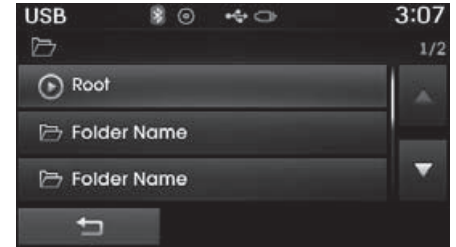

Once the desired folder is displayed, press the **TUNE** knob to select.

The first file within the selected folder will begin playing.

### USB Mode Menu

Within this mode, you will have access to the Info, Random(Shuffle), Repeat, Copy and List features.



<for RDS model>

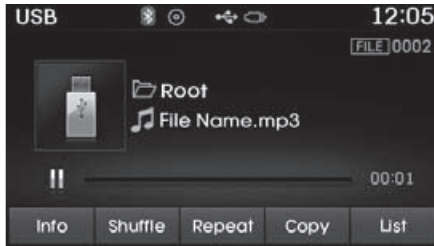

### Info

Press the **i** (Info) button to display details about the current file.

### \* NOTICE

- When the 'Folder File' option is set as the default display within Display setup, the album/artist/file information are displayed as detailed file information.
- When the 'Album Artist Song' option is set as the default display, the folder name/file name are displayed as detailed file information.
- The title, artist and album info are displayed only when such information are recorded within the MP3 file ID3 tag.

### Random(Shuffle)

Press the **⇄** (Shuffle) button to play files in random(Shuffle) order.

Each time the button is pressed, the feature changes in order of Random(Shuffle) Folder→Random(Shuffle) All→Off.

- Random(Shuffle) Folder : Plays the files in the current folder in random(Shuffle) order.
- Random(Shuffle) All : Plays all files in random(Shuffle) order.

### Repeat

Press the **↺** (Repeat) button to repeat the current file or folder.

Each time the button is pressed, the feature changes in order of Repeat→Repeat Folder → Off.

- Repeat (Icon) : Repeats the current file.
- Repeat Folder (Icon) : Repeats all files within the current folder.

**Copying Files**

Press the  (Copy) button to copy the current file into My Music.

**\* NOTICE**

Selecting another feature during copying will display a pop-up asking whether you wish to cancel copying. To cancel, select 'Yes'.

**List**

Press the  (List) button to display the file list screen.

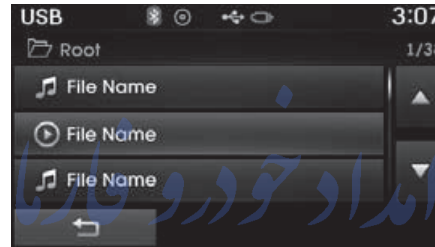

Turn the  TUNE knob left/right to search for files. Once the desired file is displayed, press the knob to select and play.

[FarmaSOS.com](http://FarmaSOS.com)

**\* NOTICE - USING THE iPod® DEVICE**

- iPod® is a registered trademark of Apple Inc.
- In order to use the iPod while operating the keys, you must use a dedicated iPod cable. (the cable that is supplied when purchasing iPod/iPhone products)
- If the iPod is connected to the vehicle while it is playing, a high pitch sound could occur for approximately 1-2 seconds immediately after connecting. If possible, connect the iPod to the vehicle with the iPod stopped/paused.
- During ACC ON state, connecting the iPod through the iPod cable will charge the iPod through the car audio system.
- When connecting with the iPod cable, make sure to fully insert the jack to prevent communication interference.

(Continued)

(Continued)

- When the EQ features of an external device, such as the iPod, and the audio system are both active, EQ effects could overlap and cause sound deterioration and distortion. Whenever possible, turn off the EQ feature within the external device upon use by connecting with the audio system.
- Noise may occur when an iPod or AUX device is connected. When such devices are not being used, disconnect the device for storage.
- When the iPod or AUX device power is connected to the power jack, playing the external device may result in noise. In such cases, disconnect the power connection before use.
- Skipping or improper operation may occur depending on the characteristics of your iPod/Phone device.
- If your iPhone is connected to both the Bluetooth® Wireless Technology and USB, the sound may not be properly played. In your iPhone, select the Dock connector or Bluetooth® Wireless Technology to change the sound output (source).

(Continued)

(Continued)

- iPod mode cannot be operated when the iPod cannot be recognized due to the playing of versions that do not support communication protocols, cases of iPod abnormalities and defects.
- For fifth generation iPod Nano devices, the iPod may not be recognized when the battery level is low. Please charge the iPod for use.
- Search/play orders shown within the iPod device may differ with the orders shown within the audio system.
- If the iPod malfunctions due to an iPod device defect, reset the iPod and try again. (To learn more, refer to your iPod manual)
- Some iPods may not sync with the System depending on its version. If the Media is removed before the Media is recognized, then the system may not properly restore the previously operated mode. (iPad charging is not supported.)

## iPod MODE

### Basic Mode Screen

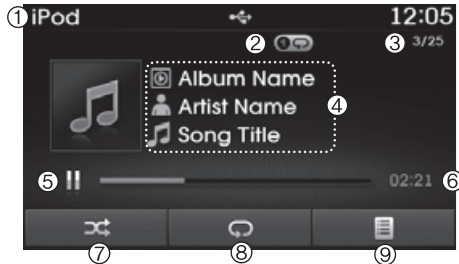

<for RDS model>

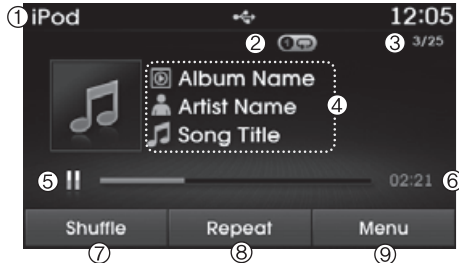

#### 1. Mode

Displays currently operating mode

#### 2. Operation State

From Repeat/Random(Shuffle), displays the currently operating function

#### 3. Song Index

Displays the current song/total number of songs

#### 4. Song Info

Displays information about the current song

#### 5. Play/Pause

Changes the play/pause state

#### 6. Play Time

Displays the current play time

#### 7. Random(Shuffle)

Turns the Random(Shuffle) feature on/off

#### 8. Repeat

Turns the Repeat feature on/off

#### 9. List

Moves to the list screen



### Using iPod Mode

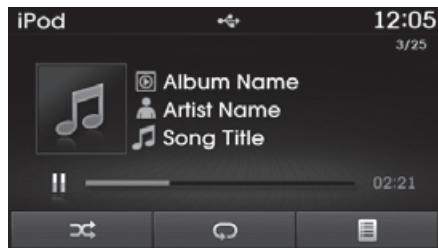

#### Playing/Pausing iPod Songs

Once an iPod is connected, the mode will automatically start and begin playing an iPod song.

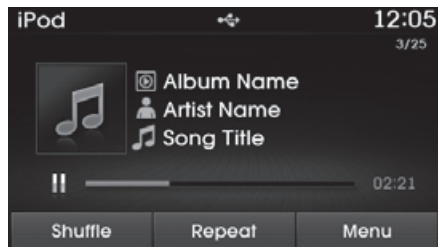

<for RDS model>



While playing, press the  button to pause and press  button to play.

### \* NOTICE

iPods with unsupported communication protocols may not properly operate in the audio system.

امداد خودرو فارما

تلفن شبانه روزی: ۰۲۱-۸۸۸۶۲۰۸۵

FarmaSOS.com

### Changing Songs

Press the  key to move to the previous or next song.

### \* NOTICE

- Pressing the  key after the song has been playing for 3 seconds will start the current song from the beginning.
- Pressing the  key before the song has been playing for 3 seconds will start the previous song.
- Slight time differences may exist depending your iPod product.

### Rewinding / Fast-forwarding Songs

While playing, press and hold the  key (over 0.8 seconds) to rewind or fast-forward the current song.

### Searching Categories

Turn the **TUNE** knob left/right to search for the desired category.

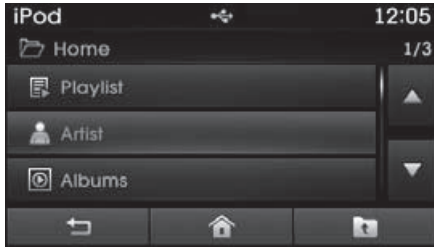

<for RDS model>

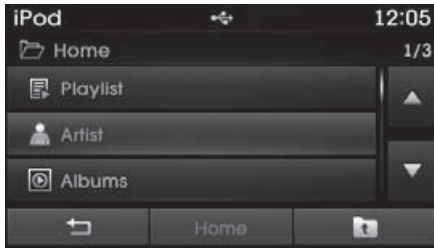

Once you find the desired category, press the **TUNE** knob to select and play.

### \* NOTICE

There are eight categories that can be searched, including **Playlists, Artists, Albums, Genres, Songs, Composers, Audiobooks and Podcasts.**

امداد خودرو فارما

تلفن شبانه روزی: ۰۲۱-۸۸۸۶۲۰۸۵

FarmaSOS.com

### Category Menu

Within the iPod Category menu, you will have access to the **Back**, **Home**, and **Previous** features.

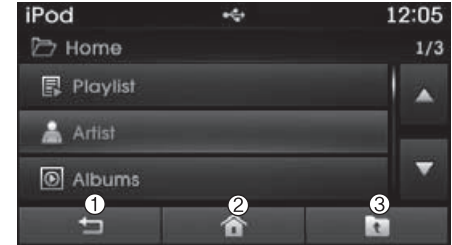

<for RDS model>

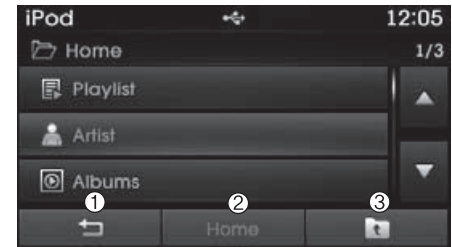

1. **Back** : Displays the play screen
2. **Home** : Moves to the iPod root category screen
3. **Previous** : Moves to the previous category

### \* NOTICE

- If the search mode is accessed while playing a song, the most recently searched category is displayed.
- Search steps upon initial connection may differ depending on the type of iPod device.

### iPod Mode Menu

Within this mode, you will have access to the Random(Shuffle), Repeat and List features.

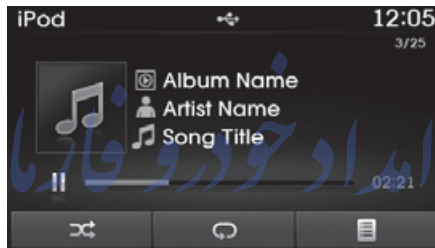

<for RDS model>

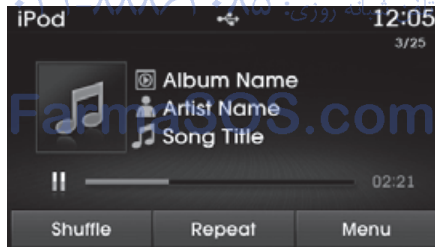

### Random(Shuffle)

Press the  (Shuffle) button to play songs in random(Shuffle) order. Each time the button is pressed, the feature changes in order of Random(Shuffle) Album→Random(Shuffle) All→Off.

- Random(Shuffle) Album : Shuffle Album plays album in Random(Shuffle) order.
- Random(Shuffle) All : Plays all songs in Random(Shuffle) order.

### Repeat

Press the  (Repeat) button to repeat the current song. Press the button again to turn the repeat feature off.

- Repeat : Repeats the current song

**List**

Press the  (List) button to display the Category Menu.

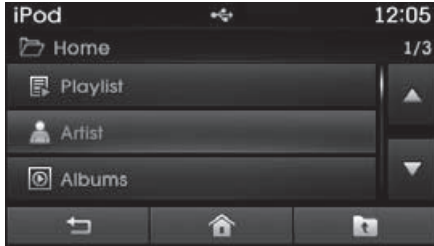

<for RDS model>

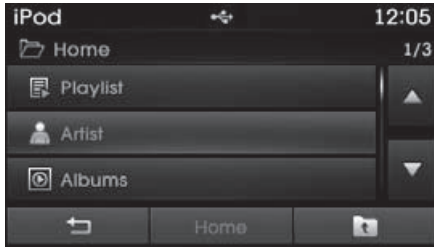

Turn the  TUNE knob left/right to search for the desired category.

Once you find the desired category, press the  TUNE knob to select and play.

**AUX MODE**

**Using AUX Mode**

Press the  key ▶ Select [AUX]

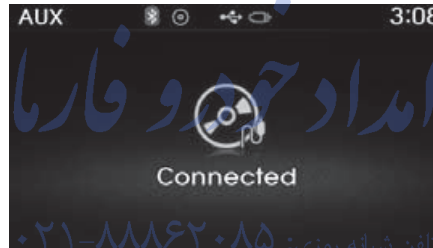

An external device can be connected to play music.

**Connecting an External Device**

External audio players (Camcorders, car VCR, etc.) can be played through a dedicated cable.

**\* NOTICE**

- If an external device connector is connected with the AUX terminal, then AUX mode will automatically operate. Once the connector is disconnected, the previous mode will be restored.
- AUX mode can be used only when an external audio player (camcorder, car VCR, etc.) has been connected.
- The AUX volume can be controlled separately from other audio modes.
- Connecting a connector jack to the AUX terminal without an external device will convert the system to AUX mode, but only output noise. When an external device is not being used, also remove the connector jack.
- When the external device power is connected to the power jack, playing the external device may output noise. In such cases, disconnect the power connection before use.
- Fully insert the AUX cable to the AUX jack upon use.

## MY MUSIC MODE

### Basic Mode Screen



<for RDS model>



#### 1. Mode

Displays currently operating mode

#### 2. Operation State

From Repeat/Random(Shuffle)/ Scan, displays the currently operating function

#### 3. File Index

Displays the current file/total number of files

#### 4. File Info

Displays information about the current file

#### 5. Play/Pause

Changes the play/pause state

#### 6. Play Time

Displays the current play time

#### 7. Info

Displays detailed information for the current file

#### 8. Random(Shuffle)

Turns the Random(Shuffle) feature on/off

#### 9. Repeat

Turns the Repeat feature on/off

#### 10. Delete

Deletes the current file

#### 11. List

Moves to the list screen

## Using My Music Mode

### Playing/Pausing My Music Files

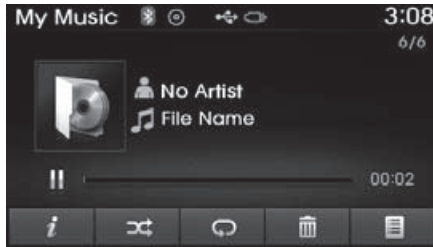

<for RDS model>

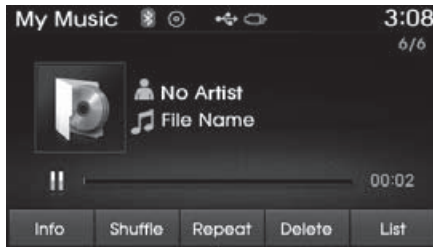

While playing, press the **||** button to pause and press **▶** button to play.

### \* NOTICE

If there are no files saved within My Music, the [My Music] button will be disabled.

### Changing Files

Press the **SEEK TRACK** key to move to the previous or next file.

### \* NOTICE

- Pressing the **SEEK TRACK** key after the file has been playing for 3 seconds will start the current file from the beginning.
- Pressing the **SEEK TRACK** key before the file has been playing for 3 seconds will start the previous file.

FarmaSOS.com

### Selecting from the List

Turn the **TUNE** knob left/right to search for the desired file.

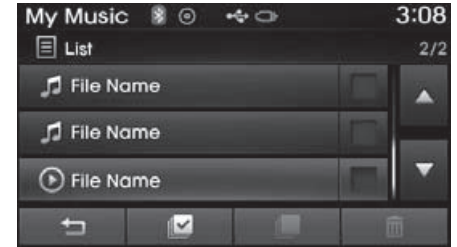

<for RDS model>

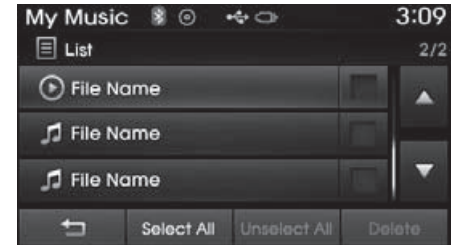

Once you find the desired file, press the **TUNE** knob to start playing.

### Rewinding / Fast-forwarding Files

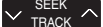
While playing, press and hold the  key (over 0.8 seconds) to rewind or fast-forward the current file.

### Scan(for RDS model)

Press and hold the  key (over 0.8 seconds) to play the first 10 seconds of each file.

### Scan

Press the  key to play the first 10 seconds of each file.

### My Music Mode Menu

Within this mode, you will have access to the Info, Random(Shuffle), Repeat, Delete and List features.

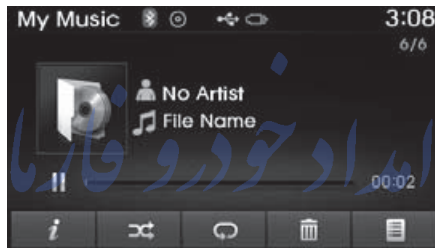

<for RDS model>

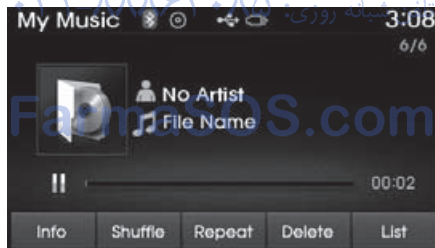

### Info

Press the  (Info) button to display details about the current file.

### \* NOTICE

The title, artist and album info are displayed only when such information is recorded within the MP3 file ID3 tag.

### Random

Press the  (Shuffle) button to play files in random order. Press the button again to turn the Random feature off.

### Repeat

Press the  (Repeat) button to repeat the current song. Press the button again to turn the repeat feature off.

### Deleting Files

Press the  (Delete) button to delete the current file.

### List

Press the  (List) button to display the file list screen.



<for RDS model>

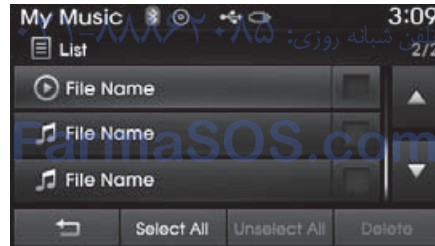

Turn the  TUNE knob left/right to search for files. Once the desired file is displayed, press the knob to select and play.

### List Menu

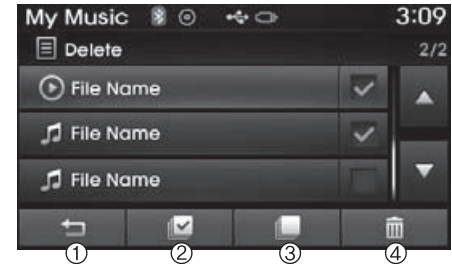

From the List screen, it is possible to delete files you previously saved into My Music.





<for RDS model>





Press the  (Select All) button or individually select the files you want to delete. Once files are selected, the  (Unselect All) button and  (Delete) buttons will be enabled.

- 1)  : Moves to the previous screen
- 2) Select All: Selects all files
- 3) Unselect All: Deselects all selected files
- 4) Delete: Deletes selected files

After selecting the files you want to delete, press the  (Delete) button to delete the selected files.

### \* NOTICE

- If there is memory available, up to 6,000 files can be saved.
- Identical files cannot be copied more than 1,000 times.
- To check memory information, go to **SETUP** ▶ [System] ▶ [Memory Information]

### \* NOTICE - USING THE *Bluetooth*<sup>®</sup> Wireless Technology Audio Mode

- *Bluetooth*<sup>®</sup> Wireless Technology Audio Mode can be used only when a *Bluetooth*<sup>®</sup> Wireless Technology phone has been connected.
- *Bluetooth*<sup>®</sup> Wireless Technology Audio Mode will not be available when connecting mobile phones that do not support this feature.
- While *Bluetooth*<sup>®</sup> Wireless Technology Audio is playing, if the *Bluetooth*<sup>®</sup> Wireless Technology phone is connected, then the music will also stop.
- Moving the Track up/down while playing *Bluetooth*<sup>®</sup> Wireless Technology audio mode may result in pop noises in some mobile phones.
- *Bluetooth*<sup>®</sup> Wireless Technology streaming audio may not be supported in some mobile phones.

(Continued)

(Continued)

- When returning to *Bluetooth*<sup>®</sup> Wireless Technology Audio mode after ending a call, the mode may not automatically restart in some mobile phones.
- Receiving an incoming call or making an outgoing call while playing *Bluetooth*<sup>®</sup> Wireless Technology Audio may result in audio interference.



## **Bluetooth® Wireless Technology AUDIO MODE (for Bluetooth® Wireless Technology equipped model)**

### **Using Bluetooth® Wireless Technology Audio Mode**

#### **Playing/Pausing Bluetooth® Wireless Technology Audio**

Once a Bluetooth® Wireless Technology device is connected, the mode will automatically start.



While playing, press the  button to pause and press  button to play.

### **\* NOTICE**

The play/pause feature may operate differently depending on the mobile phone.

#### **Changing Files**

Press the  key to move to the previous or next file.

#### **Setting Connection**

If a Bluetooth® Wireless Technology device has not been connected, press the  key ▶[Phone] button to display the Bluetooth® Wireless Technology connection screen.

It is possible to use the pair phone, connect/disconnect and delete features from your Bluetooth® Wireless Technology phone.

### **\* NOTICE**

- If the Bluetooth® Wireless Technology audio is not operating properly, check whether the feature is turned off at ▶[Phone] ▶[Audio streaming] (Streaming Audio). If the feature is off, turn back on and try again.
- If music is not yet playing from your mobile device after converting to Bluetooth® Wireless Technology Audio mode, pressing the play button once may start playing the mode. Check to see that music is playing from the Bluetooth® Wireless Technology device after converting to Bluetooth® Wireless Technology Audio Mode.

### **Bluetooth® Wireless Technology (for RDS, Bluetooth® Wireless Technology equipped model)**

#### **Using Bluetooth® Wireless Technology Handsfree**

- *Bluetooth®* Wireless Technology refers to a short-distance wireless networking technology which uses a 2.45GHz frequency to connect various devices within a certain distance.
- Supported within PCs, external devices, *Bluetooth®* Wireless Technology phones, PDAs, various electronic devices, and automotive environments, *Bluetooth®* Wireless Technology allows data to be transmitted at high speeds without having to use a connector cable.

- *Bluetooth®* Wireless Technology Handsfree refers to a device which allows the user to conveniently make phone calls with *Bluetooth®* Wireless Technology mobile phones through the audio system.

امداد خودرو فارما

تلفن شبانه روزی: ۰۲۱-۸۸۸۶۲۰۸۵

FarmaSOS.com

#### **CAUTION**

- *Bluetooth® Wireless Technology Handsfree is a feature that enables drivers to practice safe driving. Connecting the car audio system with a Bluetooth® Wireless Technology phone allows the user to conveniently make calls, receive calls, and manage the phone book. Before using the Bluetooth® Wireless Technology, carefully read the contents of this user's manual.*
- *Excessive use or operations while driving may lead to negligent driving practices and be the cause of accidents.*
- *Do not operate the device excessively while driving.*
- *Viewing the screen for prolonged periods of time is dangerous and may lead to accidents. When driving, view the screen only for short periods of time.*

**\* NOTICE - USING UPON CONNECTING *Bluetooth*® Wireless Technology PHONE**

- Before connecting the car audio system with the mobile phone, check to see that the mobile phone supports *Bluetooth*® Wireless Technology features.
- Even if the phone supports *Bluetooth*® Wireless Technology, the phone will not be found during device searches if the phone has been set to hidden state or the *Bluetooth*® Wireless Technology power is turned off. Disable the hidden state or turn on the *Bluetooth*® Wireless Technology power prior to searching/connecting with the car audio system.

(Continued)

(Continued)

- If you do not want to automatically connect your *Bluetooth*® Wireless Technology phone, try the following.
  1. Turn off the *Bluetooth*® Wireless Technology feature in your mobile phone.
    - For more information on *Bluetooth*® Wireless Technology features within your mobile, refer to your mobile phone user's manual.
  2. Turn off the *Bluetooth*® Wireless Technology feature in your car audio system.
    - To turn off the *Bluetooth*® Wireless Technology feature in your car audio system, go to **SETUP** > [Phone] and [Turn off] the *Bluetooth*® Wireless Technology feature.
- Park the vehicle when connecting the car audio system with your mobile phone.

(Continued)

(Continued)

- *Bluetooth*® Wireless Technology connection may become intermittently disconnected in some mobile phones. Follow these steps to try again.
  1. Turn the *Bluetooth*® Wireless Technology function within the mobile phone off/on and try again.
  2. Turn the mobile phone power Off/On and try again.
  3. Completely remove the mobile phone battery, reboot, and then again.
  4. Reboot the audio system and try again.
  5. Delete all paired devices, pair and try again.
- The Handsfree call volume and quality may differ depending on the mobile phone.

(Continued)

(Continued)

- **Bluetooth®** Wireless Technology features supported within the vehicle are as follows. Some features may not be supported depending on your **Bluetooth®** Wireless Technology device.
  - Answering and placing **Bluetooth®** Wireless Technology Handsfree calls
  - Menu operation during call (Switch to Private, Switch to call waiting, Outgoing volume)
  - Download Call History
  - Download Mobile Phone book
  - Phone book/Call History Auto Download
  - **Bluetooth®** Wireless Technology device auto connection - **Bluetooth®** Wireless Technology Audio
- It is possible to pair up to five **Bluetooth®** Wireless Technology devices to the car system.
- Only one **Bluetooth®** Wireless Technology device can be connected at a time.

(Continued)

(Continued)

- Other devices cannot be paired while a **Bluetooth®** Wireless Technology device is already connected.
- When a **Bluetooth®** Wireless Technology device is being connected, the connection process cannot be canceled.
- Only **Bluetooth®** Wireless Technology Handsfree and **Bluetooth®** Wireless Technology audio related features will operate within this system.
- Normal operation is possible only for devices that support Handsfree or audio features, such as a **Bluetooth®** Wireless Technology mobile phone or a **Bluetooth®** Wireless Technology audio device.
- Only one function can be used at a time between the **Bluetooth®** Wireless Technology Handsfree and **Bluetooth®** Wireless Technology audio. (While playing **Bluetooth®** Wireless Technology audio, streaming will end upon entering the **Bluetooth®** Wireless Technology phone screen.)

(Continued)

(Continued)

- If a connected **Bluetooth®** Wireless Technology device becomes disconnected for various reasons, such as being out of range, turning the device OFF, or a **Bluetooth®** Wireless Technology communication error, **Bluetooth®** Wireless Technology devices are automatically searched and connected.
- Placing the audio system within an electromagnetic environment may result in noise interference.

## Pairing a *Bluetooth*<sup>®</sup> Wireless Technology Device

### What is *Bluetooth*<sup>®</sup> Wireless Technology Pairing?

Pairing refers to the process of synchronizing your *Bluetooth*<sup>®</sup> Wireless Technology phone or device with the car audio system for connection. Pairing is necessary to connect and use the *Bluetooth*<sup>®</sup> Wireless Technology feature.

## Pairing **PHONE** Key / Key on the Steering Remote Controller

### When No Devices have been Paired

1. Press the **PHONE** key or the  key on the steering remote controller. The following screen is displayed.
2. Press the **OK** button to enter the Pair Phone screen.

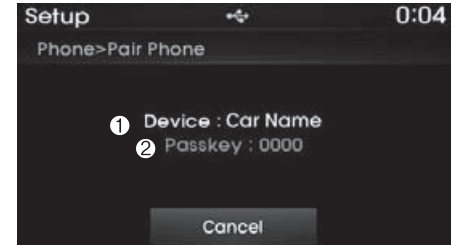

- 1) Device : Name of device as shown when searching from your *Bluetooth*<sup>®</sup> Wireless Technology device
- 2) Passkey : Passkey used to pair the device
3. From your *Bluetooth*<sup>®</sup> Wireless Technology device (i.e. Mobile Phone), search and select your car audio system.
4. After a few moments, a screen is displayed where the passkey is entered.  
Here, enter the passkey “0000” to pair your *Bluetooth*<sup>®</sup> Wireless Technology device with the car audio system.
5. Once pairing is complete, the following screen is displayed.

**\* NOTICE**



If *Bluetooth*<sup>®</sup> Wireless Technology devices are paired but none are currently connected, pressing the **PHONE** key or the  key on the steering remote controller displays the following screen. Press the [Pair] button to pair a new device or press the [Connect] to connect a previously-pair device.

**Pairing through [PHONE] Setup**

Press the **SETUP** key ▶ Select [Phone] ▶ Select [Pair Phone] ▶ Select 

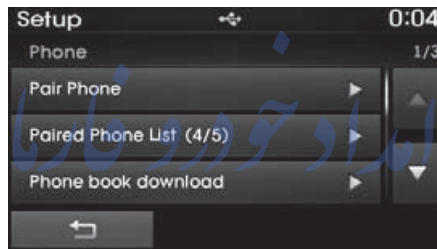

The following steps are the same as the steps described in the “When No Devices have been Paired” section.

[FarmaSOS.com](http://FarmaSOS.com)

**\* NOTICE**

- The waiting period during phone pairing will last for one minute. The pairing process will fail if the device is not paired within the given time. If the pairing process fails, you must start the process from the beginning.
- Generally, most *Bluetooth*<sup>®</sup> Wireless Technology devices will automatically connect once pairing is complete. However, some devices may require a separate verification process to connect. Check to see whether *Bluetooth*<sup>®</sup> Wireless Technology has been properly connected within your mobile phone.
- List of paired *Bluetooth*<sup>®</sup> Wireless Technology devices can be viewed at **SETUP** ▶ [Phone] ▶ [Paired Phone List].

## Connecting a Device

Press the **SETUP** key ▶ Select [Phone] ▶ Select [Paired Phone List]

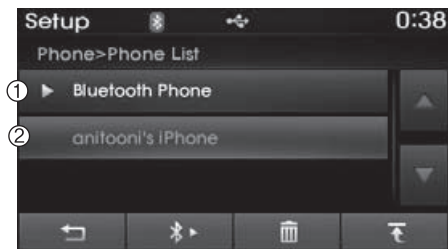

- 1) Connected Phone : Device that is currently connected
- 2) Paired Phone : Device that is paired but not connected

From the paired phone list, select the device you want to connect and press the **Bluetooth** button.

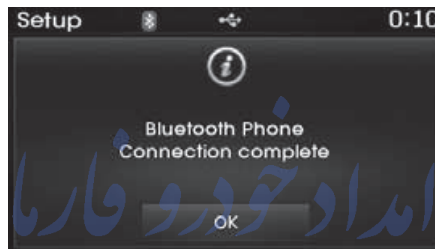

تلفن شبانه روزی: ۰۲۱-۸۸۸۶۲۰۸۵

[FarmaSOS.com](http://FarmaSOS.com)



### Changing Priority

#### What is Priority?

It is possible to pair up to five *Bluetooth*® Wireless Technology devices with the car audio system. As a result, the “Change Priority” feature is used to set the connection priority of paired phones. However, the most recently connected phone will always be set as the highest priority.

Press the **SETUP** key ▶ Select [Phone] ▶ Select [Paired Phone List]



From the paired phone list, select the phone you want to change to the highest priority, then press the **↕** button from the Menu. The selected device will be changed to the highest priority.

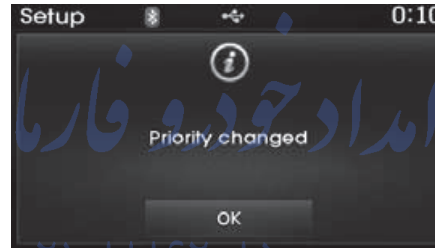

#### \* NOTICE

When a device is currently connected, even if you change the priority to a different device, the currently connected phone will always be set as the highest priority.

### Disconnecting a Device

Press the **SETUP** key ▶ Select [Phone] ▶ Select [Paired Phone List]

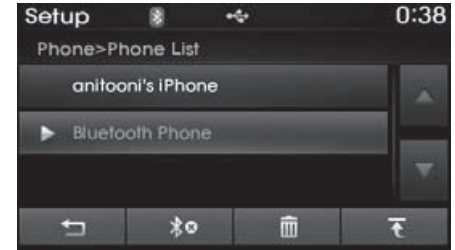

From the paired phone list, select the currently connected device and press the **⌘** button.

## Deleting a Device

Press the **SETUP** key ▶ Select [Phone] ▶ Select [Paired Phone List]

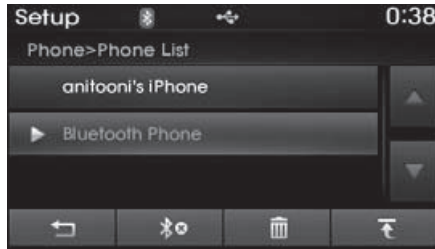

From the paired phone list, select the device you want to delete and press the **🗑️** button.

### \* NOTICE

- When deleting the currently connected device, the device will automatically be disconnected to proceed with the deleting process.
- If a paired *Bluetooth*® Wireless Technology device is deleted, the device's call history and phone book data will also be deleted.
- To re-use a deleted device, you must pair the device again.

## USING *Bluetooth*® Wireless Technology

### Phone Menu Screen

#### Phone Menus

With a *Bluetooth*® Wireless Technology device connected, press the **PHONE** key to display the Phone menu screen.



- 1) Dial Number : Displays the dial screen where numbers can be dialed to make calls
- 2) Call History : Displays the call history list screen

- 3) Phone book : Displays the Phone book list screen
- 4) Setup : Displays Phone related settings

### \* NOTICE

- If you press the [Call History] button but there is no call history data, a prompt is displayed which asks whether to download call history data.
- If you press the [Phone book] button but there is no phone book data, a prompt is displayed which asks whether to download phone book data.
- This feature may not be supported in some mobile phones. For more information on download support, refer to your mobile phone user's manual.

## Calling by Dialing a Number

Press the **PHONE** key ▶ Select [Dial Number]



- 1) Dial Pad : Used to enter phone number
- 2) Call : If a number has been entered, calls the number. If no number has been entered, switches to call history screen
- 3) End : Deletes the entered phone number
- 4) Delete : Deletes entered numbers one digit at a time

## Answering Calls

### Answering a Call

Answering a call with a *Bluetooth®* Wireless Technology device connected will display the following screen.



- 1) Caller : Displays the other party's name when the incoming caller is saved within your phone book
- 2) Incoming Number : Displays the incoming number
- 3) Accept : Accept the incoming call
- 4) Reject : Reject the incoming call

## \* NOTICE

- When the incoming call pop-up is displayed, most Audio and SETUP mode features will not operate. Only the call volume can be operated.
- The telephone number may not be properly displayed in some mobile phones.
- When a call is answered with the mobile phone, the call mode will automatically convert to Private mode.

**During a Handsfree Call**



- 1) Caller : Displays the other party's name if the incoming caller is saved within your phone book
- 2) Incoming Number : Displays the incoming number
- 3) Call time : Displays the call time
- 4) End : Ends call
- 5) Private : Converts to Private mode
- 6) Out Vol. : Sets call volume as heard by the other party
- 7) Mute : Turns Mic Mute On/Off

**\* NOTICE**

If the mic is muted, the other party will not be able to hear your voice.

**Call History**

Press the **PHONE** key ▶ Select [Call History]



A list of incoming, outgoing and missed calls is displayed.

Press the [Download] button to download the call history.

- 1) Call History :
  - Displays recent calls (call history)
  - Connects call upon selection
- 2) Download : Download Recent Call History

**\* NOTICE**

- The call history list will display up to 30 outgoing, incoming, and missed calls.
- Upon downloading call histories, previously saved histories are deleted.
- Incoming calls with hidden caller IDs will not be saved in the call history list.
- Previously saved phone book entries are stored even if a device is disconnected and re-connected.
- The download feature may not be supported in some mobile phones. Check to see that the *Bluetooth*® Wireless Technology device supports the download feature.

### Phone Book

Press the **PHONE** key ▶ Select [Phone book]

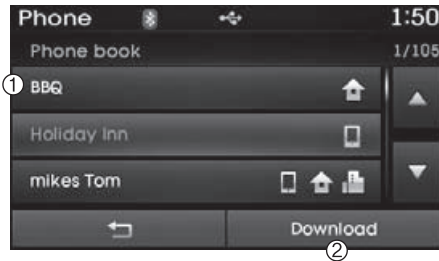

The list of saved phone book entries is displayed. Press the [Download] button to download the call history.

#### 1) Contact List :

- Displays downloaded phone book entries
- Connects call upon selection

#### 2) Download : Download phone book entries

### \* NOTICE

- Up to 1,000 phone book entries can be copied into car phone book.
- Upon downloading phone book data, previously saved phone book data will be deleted.
- Downloading is not possible if the phone book download feature is turned off within the *Bluetooth*<sup>®</sup> Wireless Technology device. Also, some devices may require device authorization upon attempting to download. If downloading cannot be normally conducted, check the *Bluetooth*<sup>®</sup> Wireless Technology device setting or the screen state.
- Caller ID information will not be displayed for unsaved callers.
- The download feature may not be supported in some mobile phones. Check to see that the *Bluetooth*<sup>®</sup> Wireless Technology device supports the download feature.

## **Bluetooth® Wireless Technology (for Bluetooth® Wireless Technology equipped model)**



### **Pairing a Bluetooth® Wireless Technology wireless technologi- gy Device**

#### **What is Bluetooth® Wireless Technology Pairing?**

Pairing refers to the process of synchronizing your Bluetooth® Wireless Technology phone or device with the car audio system for connection. Pairing is necessary to connect and use the Bluetooth® Wireless Technology feature.

### **Pairing Key / Key on the Steering Remote Controller**

#### *When No Devices have been Paired*

1. Press the  key or the  key on the steering remote controller. The following screen is displayed.
2. Press the  button to enter the Pair Phone screen.

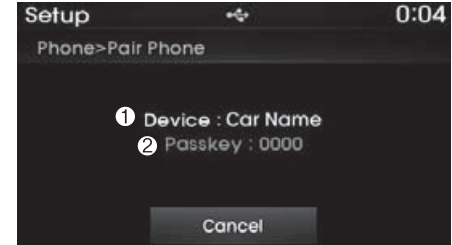
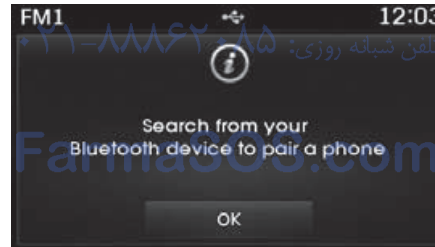

- 1) Device : Name of device as shown when searching from your Bluetooth® Wireless Technology device
- 2) Passkey : Passkey used to pair the device
3. From your Bluetooth® Wireless Technology device (i.e. Mobile Phone), search and select your car audio system.
4. After a few moments, a screen is displayed where the passkey is entered.  
Here, enter the passkey “0000” to pair your Bluetooth® Wireless Technology device with the car audio system.
5. Once pairing is complete, the following screen is displayed.

**\* NOTICE**

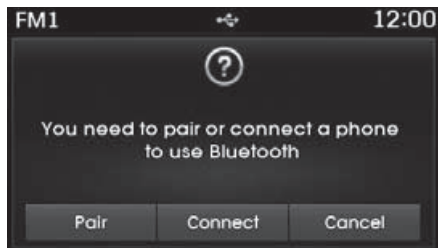

If *Bluetooth*<sup>®</sup> Wireless Technology devices are paired but none are currently connected, pressing the **PHONE** key or the  key on the steering remote controller displays the following screen. Press the [Pair] button to pair a new device or press the [Connect] to connect a previously pair device.

**Pairing through [PHONE] Setup**

Press the **SETUP** key ▶ Select [Phone] ▶ Select [Pair Phone] ▶ Select 

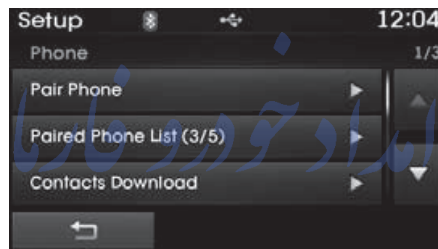

The following steps are the same as the steps described in the “When No Devices have been Paired” section.

FarmaSOS.com

**\* NOTICE**

- The waiting period during phone pairing will last for one minute. The pairing process will fail if the device is not paired within the given time. If the pairing process fails, you must start the process from the beginning.
- Generally, most *Bluetooth*<sup>®</sup> Wireless Technology devices will automatically connect once pairing is complete. However, some devices may require a separate verification process to connect. Check to see whether *Bluetooth*<sup>®</sup> Wireless Technology has been properly connected within your mobile phone.
- List of paired *Bluetooth*<sup>®</sup> Wireless Technology devices can be viewed at **SETUP** ▶ [Phone] ▶ [Paired Phone List].

## Connecting a Device

Press the **SETUP** key ▶ Select [Phone] ▶ Select [Paired Phone List]



- 1) Connected Phone : Device that is currently connected
- 2) Paired Phone : Device that is paired but not connected

From the paired phone list, select the device you want to connect and press the **Connect** button.

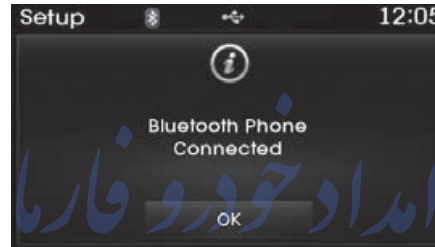

تلفن شبانه روزی: ۰۲۱-۸۸۸۶۲۰۸۵

FarmaSOS.com

## Changing Priority

### What is Priority?

It is possible to pair up to five *Bluetooth*® Wireless Technology devices with the car audio system. As a result, the "Change Priority" feature is used to set the connection priority of paired phones. However, the most recently connected phone will always be set as the highest priority.

Press the **SETUP** key ▶ Select [Phone] ▶ Select [Paired Phone List]





From the paired phone list, select the phone you want to change to the highest priority, then press the **Change priority** button from the Menu. The selected device will be changed to the highest priority.

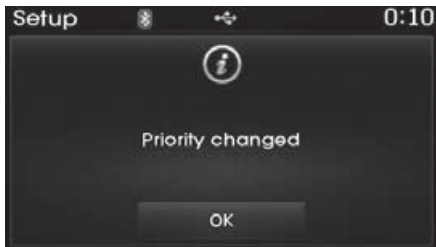

### \* NOTICE

When a device is currently connected, even if you change the priority to a different device, the currently connected phone will always be set as the highest priority.

### Disconnecting a Device

Press the **SETUP** key ▶ Select [Phone] ▶ Select [Paired Phone List]

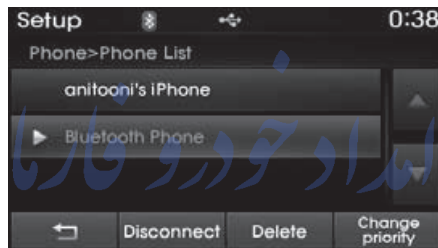

From the paired phone list, select the currently connected device and press the **Disconnect** button.

[FarmaSOS.com](http://FarmaSOS.com)

### Deleting a Device

Press the **SETUP** key ▶ Select [Phone] ▶ Select [Paired Phone List]

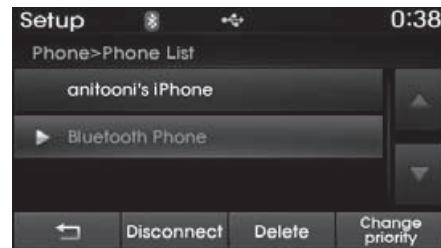

From the paired phone list, select the device you want to delete and press the **Delete** button.

**\* NOTICE**

- When deleting the currently connected device, the device will automatically be disconnected to proceed with the deleting process.
- If a paired *Bluetooth*® Wireless Technology device is deleted, the device's call history and contacts data will also be deleted.
- To re-use a deleted device, you must pair the device again.

**USING *Bluetooth*® Wireless Technology**

**Phone Menu Screen**

*Phone Menus*

With a *Bluetooth*® Wireless Technology device connected, press the **PHONE** key to display the Phone menu screen.



- 1) Dial Number : Displays the dial screen where numbers can be dialed to make calls
- 2) Call History : Displays the call history list screen

- 3) Contacts : Displays the Contacts list screen
- 4) Setup : Displays Phone related settings

**\* NOTICE**

- If you press the [Call History] button but there is no call history data, a prompt is displayed which asks whether to download call history data.
- If you press the [contacts] button but there is no contacts data, a prompt is displayed which asks whether to download contacts data.
- This feature may not be supported in some mobile phones. For more information on download support, refer to your mobile phone user's manual.

## Calling by Dialing a Number

Press the **PHONE** key ▶ Select [Dial Number]

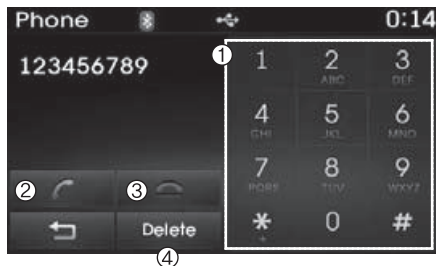

- 1) Dial Pad : Used to enter phone number
- 2) Call : If a number has been entered, calls the number. If no number has been entered, switches to call history screen
- 3) End : Deletes the entered phone number
- 4) Delete : Deletes entered numbers one digit at a time

## Answering Calls

### Answering a Call

Answering a call with a *Bluetooth®* Wireless Technology device connected will display the following screen.

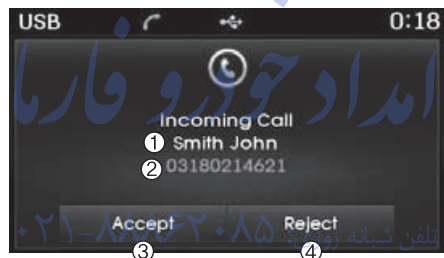

- 1) Caller : Displays the other party's name when the incoming caller is saved within your contacts
- 2) Incoming Number : Displays the incoming number
- 3) Accept : Accept the incoming call
- 4) Reject : Reject the incoming call

## \* NOTICE

- When the incoming call pop-up is displayed, most Audio and SETUP mode features will not operate. Only the call volume can be operated.
- The telephone number may not be properly displayed in some mobile phones.
- When a call is answered with the mobile phone, the call mode will automatically convert to Private mode.

### During a Handsfree Call



- 1) Caller : Displays the other party's name if the incoming caller is saved within your contacts
- 2) Incoming Number : Displays the incoming number
- 3) Call time : Displays the call time
- 4) End : Ends call
- 5) Private : Converts to Private mode
- 6) Out Vol. : Sets call volume as heard by the other party
- 7) Mute : Turns Mic Mute On/Off

### \* NOTICE

If the mic is muted, the other party will not be able to hear your voice.

### Call History

Press the **PHONE** key ▶ Select [Call History]



A list of incoming, outgoing and missed calls is displayed.

Press the **Download** button to download the call history.

- 1) Call History :
  - Displays recent calls (call history)
  - Connects call upon selection
- 2) Download : Download Recent Call History

### Contacts

Press the **PHONE** key ▶ Select [Contacts]

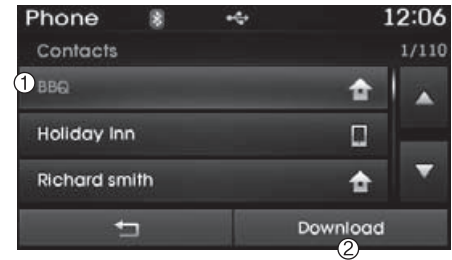

The list of saved phone book entries is displayed. Press the **Download** button to download the call history.

- 1) Contacts List :
  - Displays downloaded contacts entries
  - Connects call upon selection
- 2) Download : Download contacts entries

### \* NOTICE

- Up to 1,000 contacts entries can be copied into car contacts.
- Upon downloading contacts data, previously saved contacts data will be deleted.
- Downloading is not possible if the contacts download feature is turned off within the *Bluetooth*<sup>®</sup> Wireless Technology device. Also, some devices may require device authorization upon attempting to download. If downloading cannot be normally conducted, check the *Bluetooth*<sup>®</sup> Wireless Technology device setting or the screen state.
- Caller ID information will not be displayed for unsaved callers.
- The download feature may not be supported in some mobile phones. Check to see that the *Bluetooth*<sup>®</sup> Wireless Technology device supports the download feature.

امداد خودرو فارما

تلفن شبانه روزی: ۰۲۱-۸۸۸۶۲۰۸۵

FarmaSOS.com

## \* NOTICE - USING THE Voice Recognition

- When using the voice recognition feature, only commands listed within the user's manual are supported.
- Be aware that during the operation of the voice recognition system, pressing any key other than the  key or touching the screen will terminate voice recognition mode.
- For superior voice recognition performance, position the microphone used for voice recognition above the head of the driver's seat and maintain a proper position when saying commands.
- Within the following situations, voice recognition may not function properly due to external sound.
  - When the windows and sunroof are open
  - When the wind of the cooling / heating device is strong
  - When entering and passing through tunnels
  - When driving on rugged and uneven roads

(Continued)

(Continued)

- During severe rain (heavy rains, windstorms)
- Phone related voice commands can be used only when a *Bluetooth*<sup>®</sup> Wireless Technology device is connected.
- When making calls by stating a name, the corresponding contact must be downloaded and stored within the audio system.
- After downloading the *Bluetooth*<sup>®</sup> Wireless Technology phone book, it takes some times to convert the phone book data into voice information. During this time, voice recognition may not properly operate.
- Pronounce the voice commands naturally and clearly as if in a normal conversation.

## VOICE RECOGNITION (if equipped)

### Using Voice Recognition

#### Starting Voice Recognition

Shortly press the  key on the steering remote controller .Say a command

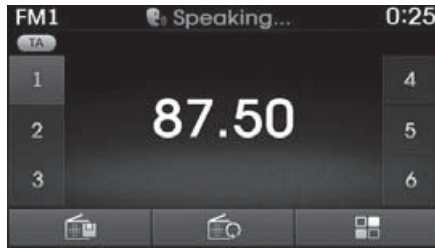

If voice recognition is in [Normal Mode], then the system will say “Please say a command. Beep~”

- If voice recognition is in [Expert Mode], then the system will only say a “Beep~”
- To change the Normal Mode/Expert Mode setting, go to **SETUP** ▶ [System] ▶ [Prompt Feedback].

### \* NOTICE

For proper recognition, say the command after the voice instruction and beep tone.

#### Skipping Prompt Messages

While prompt message is being stated▶ Shortly press the  key on the steering remote controller (under 0.8 seconds)

The prompt message is immediately ended and the beep tone will sound. After the “beep”, say the voice command.

#### Re-starting Voice Recognition

While system waits for a command▶ Shortly press the  key on the steering remote controller (under 0.8 seconds)

The command wait state is immediately ended and the beep ton will sound. After the “beep”, say the voice command.

## ENDING VOICE RECOGNITION

While Voice Recognition is operating  
▶ Press and hold the  key on the steering remote controller (over 0.8 seconds)

### \* NOTICE

- While using voice command, pressing a steering wheel remote control or a different key will end voice command.
- In a state where the system is waiting for a voice command, say “cancel” or “end” to end voice command.
- In a state where the system is waiting for a voice command, press and hold the  key on the steering remote controller to end voice command.

امداد خودرو فارما

تلفن شبانه روزی: ۰۲۱-۸۸۸۶۲۰۸۵

FarmaSOS.com



\* Illustration on using voice commands

## • Starting voice command.

Shortly pressing the  key (under 0.8 seconds):

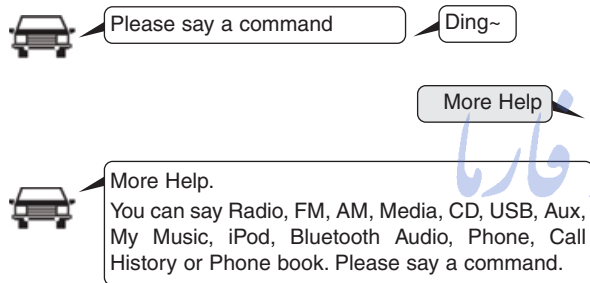

## • Skipping Voice Recognition

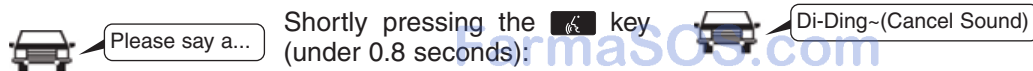

## • End voice command.

Shortly pressing the  key (under 0.8 seconds):

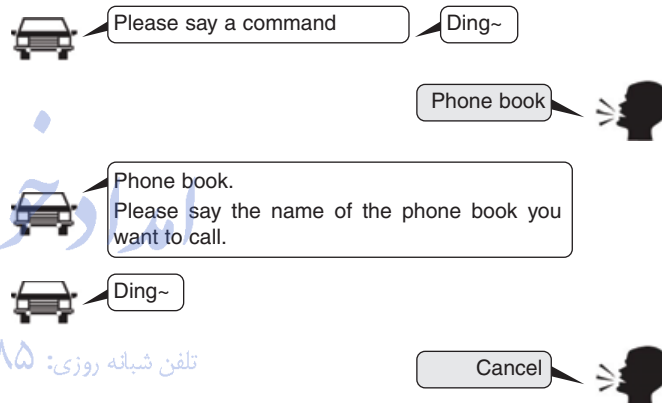

## Voice Command List

- **Common Commands:** These are commands that can be used in all situations. (However, some commands may not be supported in special circumstances.)

Command	Function
More Help	Provides guidance on commands that can be used anywhere in the system.
Help	Provides guidance on commands that can be used within the current mode.
Call<Name>	Calls <Name> saved in phone book Ex) Call "John"
Phone	Provides guidance on Phone related commands. After saying this command, say "Call History", "Phone book", "Dial Number" to execute corresponding functions.
Call History	Displays the Call History screen.
Phone book	Displays the phone book screen. After saying this command, say the name of a phone book saved in the phone book to automatically connect the call.
Dial Number	Display the Dial number screen. After saying this command, you can say the number what you want to call.
Redial	Connects the most recently called number.
Radio	<ul style="list-style-type: none"> <li>• When listening to the radio, displays the next radio screen. (FM1→ FM2→ FMA → AM → AMA)</li> <li>• When listening to a different mode, displays the most recently played radio screen.</li> </ul>

Command	Function
FM	<ul style="list-style-type: none"> <li>• When currently listening to the FM radio, maintains the current state.</li> <li>• When listening to a different mode, displays the most recently played FM screen.</li> </ul>
FM1(FM One)	Displays the FM1 screen.
FM2(FM Two)	Displays the FM2 screen.
FMA	Displays the FMA screen.
AM	Displays the AM screen.
AMA	Displays the AMA screen.
FM Preset 1~6	Plays the most recently played broadcast saved in FM Preset 1~6.
AM Preset 1~6	Plays the broadcast saved in AM Preset 1~6.
FM 87.5~107.9	Plays the FM broadcast of the corresponding frequency.
AM 530~1710	Plays the AM broadcast of the corresponding frequency.
TA on	Enable Traffic Announcement
TA off	Disable Traffic Announcement
News on	Enable RDS News feature
News off	Disable RDS News feature

Command	Function
Media	Moves to the most recently played media screen.
Play Track 1~30	If a music CD has been inserted, plays the corresponding track.
CD	Plays the music saved in the CD.
Search CD	Moves to the CD track or file selection screen. <ul style="list-style-type: none"> <li>• For audio CDs, move to the screen and say the track number to play the corresponding track.</li> <li>• Moves to MP3 CD file selection screen. After manually operate the device to select and play music.</li> </ul>
USB	Plays USB music.
Search USB	Moves to USB file selection screen. After manually operate the device to select and play music.
iPod	Plays iPod music.
Search iPod	Moves to the iPod file selection screen. After, manually operate the device to select and play music.
My Music	Plays the music saved in My Music.
Search My Music	Moves to My Music file selection screen. After manually operate the device to select and play music.

Command	Function
AUX (Auxiliary)	Plays the connected external device.
Bluetooth Audio	Plays the music saved in connected <i>Bluetooth®</i> Wireless Technology device.
Mute	Mutes the radio or music volume.
Pardon?	Repeats the most recent comment.
Cancel (Exit)	Ends voice command.

تلفن شبانه روزی: ۰۲۱-۸۸۸۶۲۰۸۵

FarmaSOS.com

- FM/AM radio commands: Commands that can be used while listening to FM, AM radio.

Command	Function
Preset 1~6	Plays the broadcast saved in Preset 1~6.
Auto Store	Automatically selects radio broadcast frequencies with superior reception and saves in Presets 1~6.
Preset Save 1~6	Saves the current broadcast frequency to Preset 1~6.
Seek up	Plays the next receivable broadcast.
Seek down	Plays the previous receivable broadcast.
Next Preset	Selects the preset number next to the most recently selected preset. (Example: When currently listening to preset no. 3, then preset no. 4 will be selected.)
Previous Preset	Selects the preset number previous to the most recently selected preset. (Example: When currently listening to preset no. 3, then preset no. 2 will be selected.)
Scan	Scans receivable frequencies from the current broadcast and plays for 10 seconds each.
Preset Scan	Moves to the next preset from the current present and plays for 10 seconds each.
AF on	Enable Alternative Frequency feature
AF off	Disable Alternative Frequency feature
Region	Enable Region feature

- Audio CD commands: Commands that can be used while listening to Audio CD.

Command	Function
Region off	Disable Region feature
Program Type	Moves to the RDS Program type selection screen. After, manually operate the device to select a desired program type.
Random	Randomly plays the tracks within the CD.
Random Off	Cancels random play to play tracks in sequential order.
Repeat	Repeats the current track.
Repeat Off	Cancels repeat play to play tracks in sequential order.
Next Track	Plays the next track.
Previous Track	Plays the previous track.
Scan	Scans the tracks from the next track for 10 seconds each.
Track 1~30	Plays the desired track number.
Search Track	Moves to the track selection screen. After, say the track name to play the corresponding track.
Information	Displays the information screen of the current track.

- **MP3 CD / USB commands:** Commands that can be used while listening to music files saved in CD and USB.

Command	Function
Random	Randomly plays the files within the current folder.
All Random	Randomly plays all saved files.
Random Off	Cancels random play to play files in sequential order.
Repeat	Repeats the current file.
Folder Repeat	Repeats all files in the current folder.
Repeat Off	Cancels repeat play to play files in sequential order.
Next File	Plays the next file.
Previous File	Plays the previous file.
Scan	Scans the files from the next files for 10 seconds each.
Search File	Moves to the file selection screen.
Search Folder	Moves to the folder selection screen.
Information	Displays the information screen of the current file.
Copy	Copies the current file into My Music.

- **iPod Commands:** Commands that can be used while playing iPod.

Command	Function
All Random	Randomly plays all saved songs.
Random	Randomly plays the songs within the current category.
Random Off	Cancels random play to play songs in sequential order.
Repeat	Repeats the current song.
Repeat Off	Cancels repeat play to play songs in sequential order.
Next Song	Plays the next song.
Previous Song	Plays the previous song.
Search Song	Moves to the song selection screen.
Information	Displays the information screen of the current song.

- **My Music Commands:** Commands that can be used while playing My Music.

Command	Function
Random	Randomly plays all saved files.
Random Off	Cancels random play to play files in sequential order.
Repeat	Repeats the current file.
Repeat Off	Cancels repeat play to play files in sequential order.
Next File	Plays the next file.
Previous File	Plays the previous file.
Scan	Scans the files from the next files for 10 seconds each.
Search File	Moves to the file selection screen.
Information	Displays the information screen of the current file.
Delete	Deletes the current file. You will bypass an additional confirmation process.
Delete All	Deletes all files saved in My Music. You will bypass an additional confirmation process.

- **Bluetooth® Wireless Technology Audio Commands:** Commands that can be used while playing Phone Music.

Command	Function
Play	Plays the currently paused song.
Pause	Pauses the current song.

امداد خودرو فارما  
 تلفن شبانه روزی: ۰۲۱-۸۸۸۶۲۰۸۵  
 FarmaSOS.com

## SETUP

(for RDS, *Bluetooth*<sup>®</sup> Wireless Technology equipped model)  
- AM904DMEE, AM914DMEE

### Starting Mode

Press the **SETUP** key ▶ Select the Setup screen.

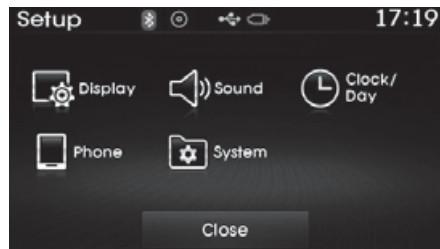

You can select and control options related to [Display], [Sound], [Clock/Day], [Phone] and [System].

## Display Settings

### Adjusting the Brightness

Press the **SETUP** key ▶ Select [Display] ▶ Select [Brightness]

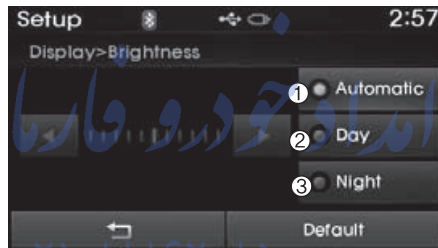

Use the **◀**, **▶** buttons to adjust the screen brightness or set the Brightness on Automatic, Day, or Night mode.

Press the **Default** button to reset.

- 1) Automatic : Adjusts the brightness automatically
- 2) Day : Always maintains the brightness on high
- 3) Night: Always maintains the brightness on low

### Pop-up Mode

Press the **SETUP** key ▶ Select [Display] ▶ Select [Pop-up Mode]

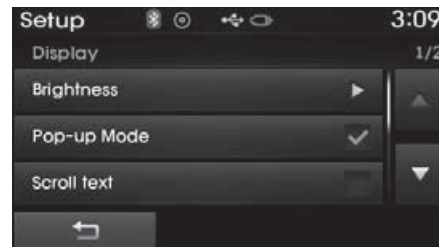

This feature is used to display the Pop-up Mode screen when entering radio and media modes.

When this feature is turned on, pressing the **RADIO** or **MEDIA** key will display the Pop-up Mode screen.

### \* NOTICE

The media Pop-up Mode screen can be displayed only when two or more media modes have been connected.

**Scroll Text**

Press the **SETUP** key ▶ Select [Display] ▶ Select [Scroll text]

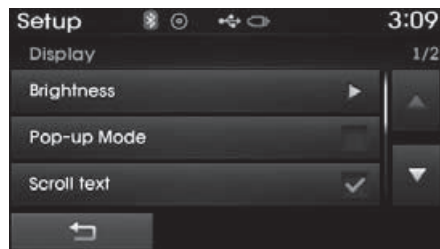

This feature is used to scroll text displayed on the screen when it is too long to be displayed at once.

When turned on, the text is repeatedly scrolled. When turned off, the text is scrolled just once.

**MP3 Information Display**

Press the **SETUP** key ▶ Select [Display] ▶ Select [Song Info]



This feature is used to change the information displayed within USB and MP3 CD modes. تلفن شبانه روزی: ۰۲۱-۸۸۸۸۸۸۸۸

- 1) Folder File : Displays file name and folder name
- 2) Album Artist Song : Displays album name/artist name/song



## Sound Settings

### Sound Settings

Press the **SETUP** key ▶ Select [Sound] ▶ Select [Audio Setting]

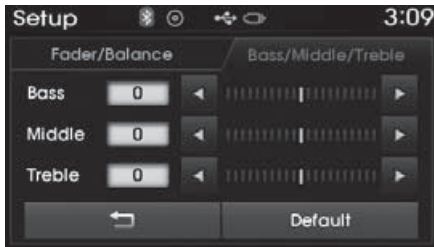

Use the ◀, ▶, ▲, ▼ buttons to adjust the Fader/Balance settings.

Use the ◀, ▶ buttons to adjust the Bass/Middle/Treble settings.

Press the **Default** button to reset.

امداد خودرو فارما

تلفن شبانه روزی: ۰۲۱-۸۸۸۶۲۰۸۵

FarmaSOS.com

### Virtual Sound

Press the **SETUP** key ▶ Select [Sound] ▶ Select [Virtual Sound]

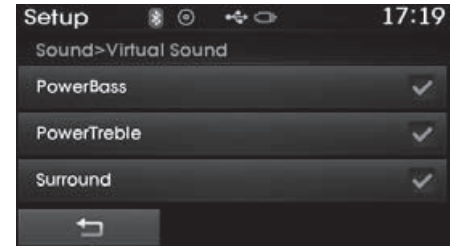

This feature is used to set the Power Bass, Power Treble and Surround sound options.

### SDVC (Speed Dependent Volume Control)

Press the **SETUP** key ▶ Select [Sound] ▶ Select [Speed Dependent Vol.]



The volume level is controlled automatically according to the vehicle speed. SDVC can be set by selecting from Off/Low/Mid/High.

### Voice Recognition Setting

Press the **SETUP** key ▶ Select [Sound] ▶ Select [Volume Dialogue]

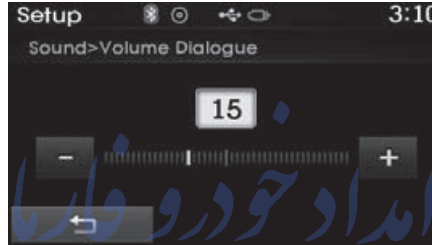

Use the **-**, **+** buttons to adjust the Volume Dialog.

تلفن شبانه روزی: ۰۲۱-۱۱۱۴۷۰۰۰  
 Press the **SETUP** key ▶ Select [Sound] ▶ Select [Touch Screen Beep]

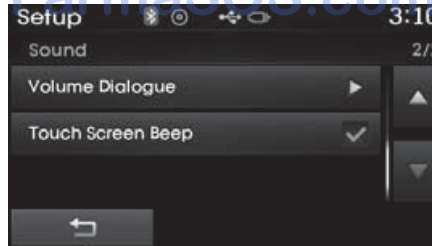

This feature is used to turn the touch screen beep on/off.

### Clock/Day Setting

#### Clock Setting

Press the **SETUP** key ▶ Select [Clock/Day] ▶ Select [Clock Settings]  
 Use the **▲**, **▼** buttons to set the Hour, Minutes and AM/PM setting.

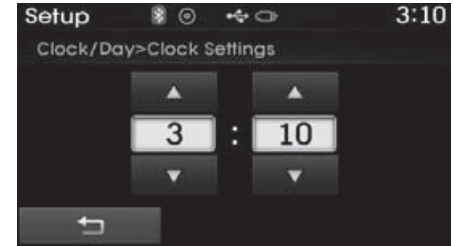

#### \* NOTICE

Press and hold the **CLOCK** key (over 0.8 seconds) to display the Clock/Day screen.

### **Calendar Setting**

Press the **SETUP** key ▶ Select [Clock/Day] ▶ Select [Day Settings]

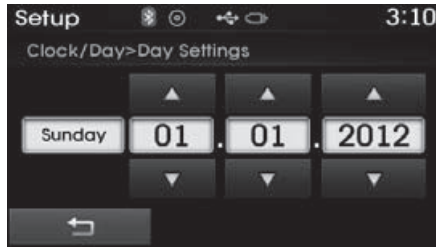

Use the **▲**, **▼** buttons to set the Day, Month and Year setting.

### **Time Format**

Press the **SETUP** key ▶ Select [Clock/Day] ▶ Select [Time Format]

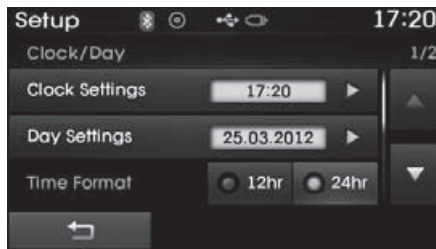

This feature is used to change the clock format between 12hr or 24hr.

### **Clock Display**

Press the **SETUP** key ▶ Select [Clock/Day] ▶ Select [Clock Display (Power off)]

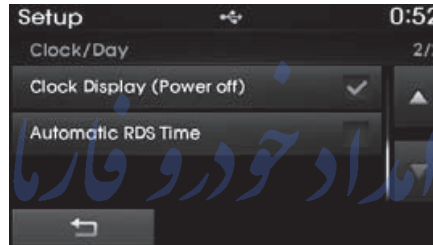

This feature is used to display a clock on the screen when the audio system is turned off.

### **Automatic RDS Time**

Press the **SETUP** key ▶ Select [Clock/Day] ▶ Select [Automatic RDS Time]

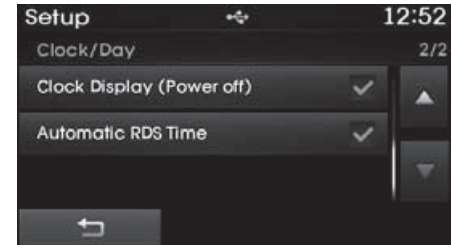

This feature is used to set time automatically by synchronizing with RDS.

FarmaSOS.com

## Bluetooth® Wireless Technology Setting

### Pairing a New Device

Press the **SETUP** key ▶ Select [Phone] ▶ Select [Pair Phone]

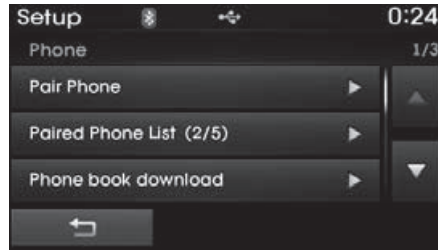

Bluetooth® Wireless Technology devices can be paired with the audio system.

For more information, refer to the “Pairing through Phone Setup” section within *Bluetooth® Wireless Technology*.

### Viewing Paired Phone List

Press the **SETUP** key ▶ Select [Phone] ▶ Select [Paired Phone List]

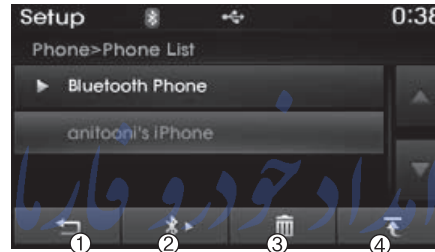

This feature is used to view mobile phones that have been paired with the audio system. Upon selecting a paired phone, the setup menu is displayed.

For more information, refer to the “Setting *Bluetooth® Wireless Technology Connection*” section within *Bluetooth® Wireless Technology*.

- 1) : Moves to the previous screen
- 2) : Connect/disconnects currently selected phone

- 3) Delete : Deletes the currently selected phone
- 4) Change Priority : Sets currently selected phone to highest connection priority

### \* NOTICE BEFORE DOWNLOADING PHONE BOOKS

- Only phone books within connected phones can be downloaded. Also check to see that your mobile phone supports the download feature.
- To learn more about whether your mobile phone supports phone book downloads, refer to your mobile phone user’s manual.
- The Phone book for only the connected phone can be downloaded. Before downloading, check to see whether your phone supports the download feature.

### Downloading Phone books

Press the **SETUP** key ▶ Select [Phone] ▶ Select [Phone book Download]



The Phone book is downloaded from the mobile phone and the download progress is displayed.

### \* NOTICE

- Up to 1,000 phone book entries can be copied into car phone book.
- Up to 1,000 phone book entries can be saved for each paired device.
- Upon downloading phone book data, previously saved phone book data will be deleted. However, Phone book entries saved to other paired phones are not deleted.

### Auto Download (Phone Book)

Press the **SETUP** key ▶ Select [Phone] ▶ Select [Auto Download]

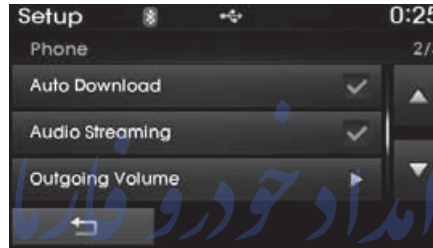

This feature is used to automatically download mobile phone book entries once a *Bluetooth*® Wireless Technology phone is connected.

### \* NOTICE

- The Auto Download feature will download mobile phone book entries every time the phone is connected. The download time may differ depending on the number of saved phone book entries and the communication state.
- When downloading a phone book, first check to see that your mobile phone supports the phone book download feature.

### Audio Streaming

Press the **SETUP** key ▶ Select [Phone] ▶ Select [Audio Streaming]

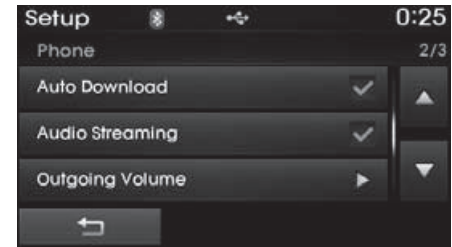

When Audio Streaming is turned on, you can play music files saved in your *Bluetooth*® Wireless Technology device from the car.

### Outgoing Volume

Press the **SETUP** key ▶ Select [Phone] ▶ Select [Outgoing Volume]

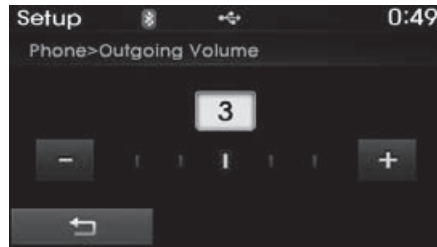

Use the **-**, **+** buttons to adjust the outgoing volume level.

### Turning Bluetooth System Off

Press the **SETUP** key ▶ Select [Phone] ▶ Select [Bluetooth System Off]

Once *Bluetooth*® Wireless Technology is turned off, *Bluetooth*® Wireless Technology related features will not be supported within the audio system.

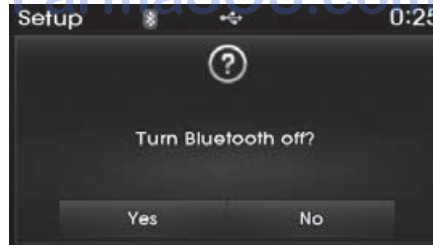
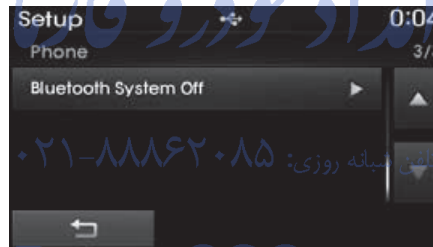

### \* NOTICE

To turn *Bluetooth*® Wireless Technology back on, go to **SETUP** ▶ [Phone] and press “Yes”.

### ⚠ CAUTION

*Bluetooth*® Wireless Technology audio streaming may not be supported in some *Bluetooth*® Wireless Technology phones.

## System Setting

### Memory Information

Press the **SETUP** key ▶ Select [System] ▶ Select [Memory Information]

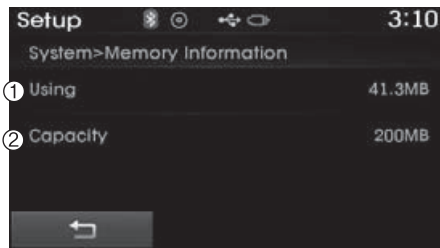

This feature displays information related to system memory.

- 1) Using : Displays capacity currently in use
- 2) Capacity : Displays total capacity

### Voice Recognition Mode Setting (if equipped)

Press the **SETUP** key ▶ Select [System] ▶ Select [Voice Recognition System]

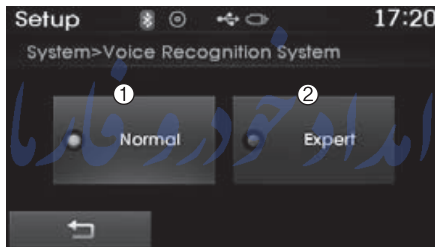

This feature is used to select the desired prompt feedback option from Normal and Expert.

- 1) Normal : When using voice recognition, provides detailed guidance prompts
- 2) Expert : When using voice recognition, omits some guidance prompts

### \* NOTICE

Voice Recognition is depend on the Audio System.

### Language

Press the **SETUP** key ▶ Select [System] ▶ Select [Language]

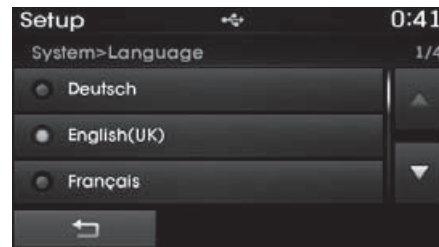

This feature is used to change the system and voice recognition language.

If the language is changed, the system will restart and apply the selected language.

## SETUP

(for *Bluetooth®* Wireless Technology equipped model)

-AM900DMMG, AM910DMMG, AM911DMMG, AM901DMGG, AM910DMEE, AM911DMEE, AM912DMEE, AM913DMEE, AM910DMGL, AM911DMGL, AM900DMMN, AM910DMMN

### Starting Mode

Press the **SETUP** key to display the Setup screen.

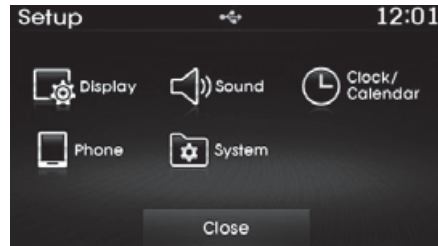

You can select and control options related to [Display], [Sound], [Clock/Calendar], [Phone] and [System].

## Display Settings

### Adjusting the Brightness

Press the **SETUP** key ▶ Select [Display] ▶ Select [Brightness]

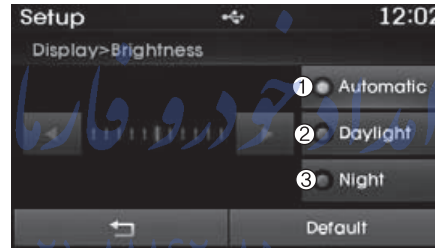

Use the **◀**, **▶** buttons to adjust the screen brightness or set the Brightness on Automatic, Daylight, or Night mode.

Press the **Default** button to reset.

- 1) Automatic : Adjusts the brightness automatically
- 2) Daylight : Always maintains the brightness on high
- 3) Night: Always maintains the brightness on low

### Pop-up Mode

Press the **SETUP** key ▶ Select [Display] ▶ Select [Mode Pop up]

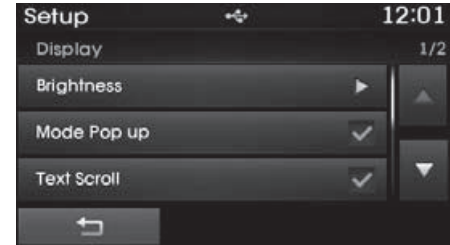

This feature is used to display the Pop-up Mode screen when entering radio and media modes.

When this feature is turned on, pressing the **RADIO** or **MEDIA** key will display the Pop-up Mode screen.

### \* NOTICE

The media Pop-up Mode screen can be displayed only when two or more media modes have been connected.



### Text Scroll

Press the **SETUP** key ▶ Select [Display] ▶ Select [Text Scroll]

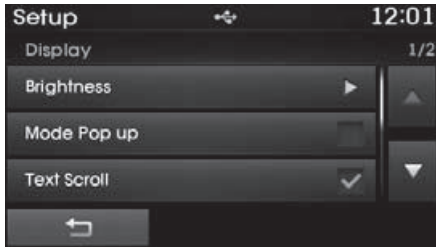

This feature is used to scroll text displayed on the screen when it is too long to be displayed at once.

When turned on, the text is repeatedly scrolled. When turned off, the text is scrolled just once.

### MP3 Information Display

Press the **SETUP** key ▶ Select [Display] ▶ Select [Media Display]



This feature is used to change the information displayed within USB and MP3 CD modes. تلفن شبانه روزی: ۰۲۱۰۰۰۰۰۰۰۰

- 1) Folder File : Displays file name and folder name
- 2) Album Artist Song : Displays album name/artist name/song

### Sound Settings

#### Sound Settings

Press the **SETUP** key ▶ Select [Sound] ▶ Select [Sound Setting]

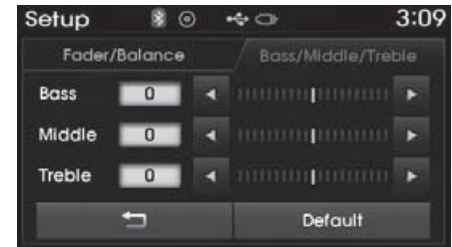

Use the ◀, ▶, ▲, ▼ buttons to adjust the Fader/Balance settings.

Use the ◀, ▶ buttons to adjust the Bass/Middle/Treble settings.

Press the **Default** button to reset.

**Virtual Sound**

Press the **SETUP** key ▶ Select [Sound] ▶ Select [Virtual Sound]

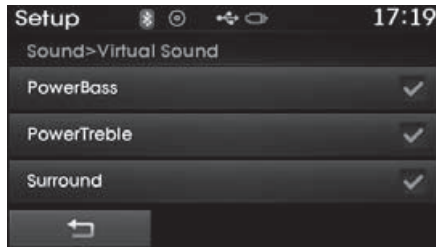

This feature is used to set the Power Bass, Power Treble and Surround sound options.

**SDVC (Speed Dependent Volume Control)**

Press the **SETUP** key ▶ Select [Sound] ▶ Select [Speed Dependent Vol.]



The volume level is controlled automatically according to the vehicle speed. SDVC can be set by selecting from Off/Low/Mid/High.

FarmasOS.com

**Touch Screen Beep**

Press the **SETUP** key ▶ Select [Sound] ▶ Select [Touch Screen Beep]

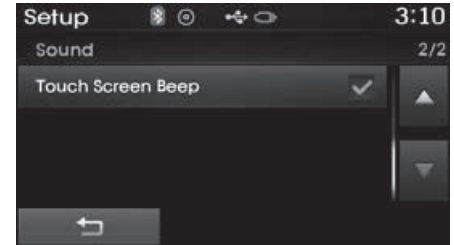

This feature is used to turn the touch screen beep on/off.

## Clock/Calendar Setting

### Clock Setting

Press the **SETUP** key ▶ Select [Clock/Calendar] ▶ Select [Clock Settings]

Use the ▲, ▼ buttons to set the Hour, Minutes and AM/PM setting.



### \* NOTICE

Press and hold the **CLOCK** key (over 0.8 seconds) to set the Clock/Calendar screen.

### Calendar Setting

Press the **SETUP** key ▶ Select [Clock/Calendar] ▶ Select [Calendar Settings]



Use the ▲, ▼ buttons to set the Day, Month and Year setting. تلفن شبانه - ۰۲۱-۸۸۸۸۸۸۸۸

### Clock Display

Press the **SETUP** key ▶ Select [Clock/Calendar] ▶ Select [Clock Display (Power off)]

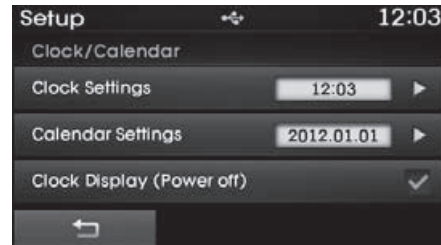

This feature is used to display a clock on the screen when the audio system is turned off.

FarmaSOS.com

## Bluetooth® Wireless Technology Setting

### Pairing a New Device

Press the **SETUP** key ▶ Select [Phone] ▶ Select [Pair Phone]

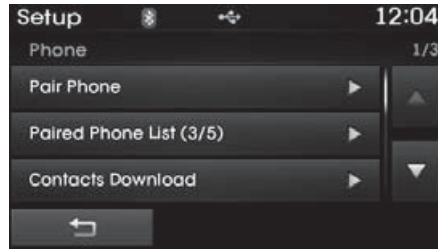

Bluetooth® Wireless Technology devices can be paired with the audio system.

For more information, refer to the “Pairing through Phone Setup” section within *Bluetooth® Wireless Technology*.

### Viewing Paired Phone List

Press the **SETUP** key ▶ Select [Phone] ▶ Select [Paired Phone List]



This feature is used to view mobile phones that have been paired with the audio system. Upon selecting a paired phone, the setup menu is displayed.

For more information, refer to the “Setting *Bluetooth® Wireless Technology Connection*” section within *Bluetooth® Wireless Technology*.

- 1)  : Moves to the previous screen
- 2) Connect/Disconnect Phone : Connect/disconnects currently selected phone

- 3) Delete : Deletes the currently selected phone
- 4) Change Priority : Sets currently selected phone to highest connection priority

### \* NOTICE BEFORE DOWNLOADING CONTACTS

- Only contacts within connected phones can be downloaded. Also check to see that your mobile phone supports the download feature.
- To learn more about whether your mobile phone supports contacts downloads, refer to your mobile phone user’s manual.
- The contacts for only the connected phone can be downloaded. Before downloading, check to see whether your phone supports the download feature.

### Downloading Contacts

Press the **SETUP** key ▶ Select [Phone] ▶ Select [Contacts Download]



The contacts is downloaded from the mobile phone and the download progress is displayed.

### \* NOTICE

- Up to 1,000 contacts entries can be copied into car contacts.
- Up to 1,000 contacts entries can be saved for each paired device.
- Upon downloading contacts data, previously saved contacts data will be deleted. However, contacts entries saved to other paired phones are not deleted.

### Auto Download (Contacts)

Press the **SETUP** key ▶ Select [Phone] ▶ Select [Auto Download]

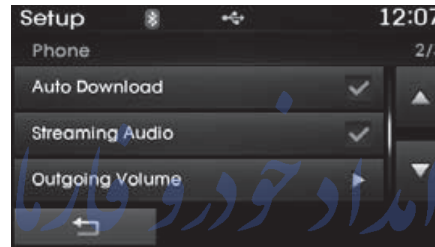

This feature is used to automatically download mobile contacts entries once a *Bluetooth*® Wireless Technology phone is connected.

### \* NOTICE

- The Auto Download feature will download mobile contacts entries every time the phone is connected. The download time may differ depending on the number of saved contacts entries and the communication state.
- When downloading a contacts, first check to see that your mobile phone supports the contacts download feature.

### Streaming Audio

Press the **SETUP** key ▶ Select [Phone] ▶ Select [Streaming Audio]

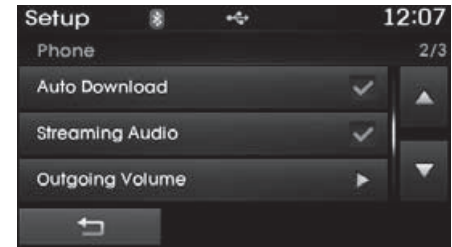

When Streaming Audio is turned on, you can play music files saved in your *Bluetooth*® Wireless Technology device from the car.

### Outgoing Volume

Press the **SETUP** key ▶ Select [Phone] ▶ Select [Outgoing Volume]

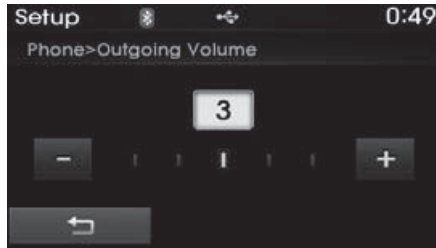

Use the **-**, **+** buttons to adjust the outgoing volume level.

### Turning Bluetooth System Off

Press the **SETUP** key ▶ Select [Phone] ▶ Select [Bluetooth System Off]

Once *Bluetooth*® Wireless Technology is turned off, *Bluetooth*® Wireless Technology related features will not be supported within the audio system.

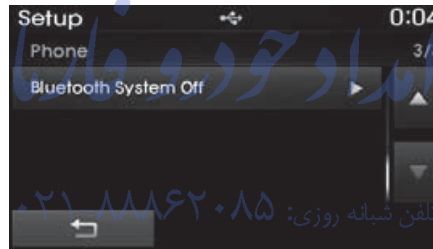

### \* NOTICE

To turn *Bluetooth*® Wireless Technology back on, go to **SETUP** ▶ [Phone] and press “Yes”.

## System Setting

### Memory Information

Press the **SETUP** key ▶ Select [System] ▶ Select [Memory Information]

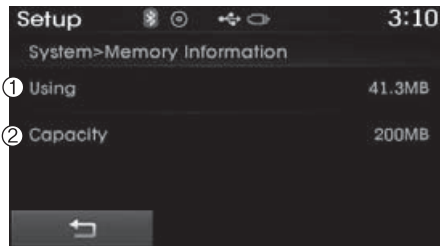

This feature displays information related to system memory.

- 1) Using : Displays capacity currently in use
- 2) Capacity : Displays total capacity

### Language

Press the **SETUP** key ▶ Select [System] ▶ Select [Language]

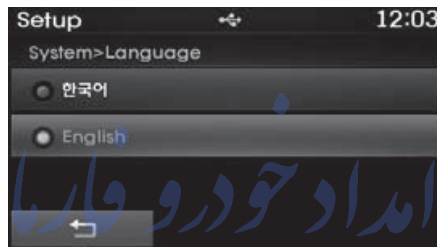

This feature is used to change the system and voice recognition language. *تلفن شبانه روزی: ۰۸۵۶۲۰۸۵*

If the language is changed, the system will restart and apply the selected language.

## REAR VIEW CAMERA (if equipped)

- The system has been equipped with a rear view camera for user safety by allowing a wider rear range of vision.
- The rear view camera will automatically operate when the ignition key is turned ON and the transmission lever is set to R.
- The rear view camera will automatically stop operating when set to a different lever.

### CAUTION

*The rear view camera has been equipped with an optical lens to provide a wider range of vision and may appear different from the actual distance. For safety, directly check the rear and left/right sides.*

## APPENDIX

Name	Description
12hr	12 HOUR
24hr	24 HOUR
AST(A.Store)	AUTO STORE
AMA	AM RADIO (AUTO STORE)
FMA	FM RADIO (AUTO STORE)
AUX	External Audio mode
BASS	BASS
TREBLE	TREBLE
BT	Bluetooth
PRESET	PRESET
RDS Search	Radio Data System Search
TA	Traffic Announcement
Radio	Radio
FM/AM/USB	FM/AM/USB
Max	MAXIMUM
Min	minimum
Low	Low
Mid	Middle
On	On
Off	Off
PowerBass	PowerBass
Setting	Setting
OK	OK
MENU	MENU
PowerTreble	PowerTreble

Name	Description
SDVC	Speed Dependent VolumeControl
Setup	Setup
CURRENT	CURRENT
Current/Total	Current/Total
DEVICE NAME	DEVICE NAME
NAME	NAME
NAME HERE	NAME HERE
NUMBER	NUMBER
PHONE NAME	PHONE NAME
Received Date	Received Date
Received Message	Received Message
Received Time	Received Time
TIME	TIME
AST	AUTO STORE
AM	AM RADIO
CD	COMPACT DISC
FM	FM RADIO(AUTO STORE)
L=R	LEFT=RIGHT
Middle	Middle
My Music	My Music
Track	Track
USB	USB



## APPENDIX

Name		Description
Phone		Phone
Engineering Mode		Engineering Mode
SEEK		SEEK
Icon		Icon

**Complies with  
IDA Standards  
DA104328**

امداد خودرو فارما

تلفن شبانه روزی: ۰۲۱-۸۸۸۶۲۰۸۵

FarmaSOS.com

# Driving your vehicle

Before driving .....	5-4	Cruise control system .....	5-64
Key .....	5-6	Speed limit control system .....	5-69
Engine start/stop button .....	5-10	Lane departure warning system (LDWS) .....	5-73
Manual transmission .....	5-17	Active ECO system .....	5-77
Automatic transmission .....	5-21	Economical operation .....	5-78
• Automatic transmission operation .....	5-22	Special driving conditions .....	5-80
Four wheel drive (4WD) .....	5-29	• Hazardous driving conditions .....	5-80
Brake system .....	5-37	• Rocking the vehicle .....	5-81
• Power brakes .....	5-37	• Smooth cornering .....	5-82
• Parking brake .....	5-39	• Driving at night .....	5-83
• Electric parking brake (EPB) .....	5-42	• Driving in the rain .....	5-83
• Auto hold .....	5-48	• Driving in flooded areas .....	5-84
• Anti-lock brake system (ABS) .....	5-51	• Driving off-road .....	5-84
• Electronic stability control (ESC) .....	5-53	• Highway driving .....	5-84
• Vehicle stability management (VSM) .....	5-57	Winter driving .....	5-86
• Trailer stability assist (TSA) .....	5-58	Trailer towing .....	5-91
• Hill-start assist control (HAC) .....	5-59		
• Emergency stop signal (ESS) .....	5-59		
• Downhill brake control (DBC) .....	5-60		

Vehicle weight .....	5-101
• Base curb weight .....	5-101
• Vehicle curb weight .....	5-101
• Cargo weight .....	5-101
• GAW (Gross axle weight) .....	5-101
• GAWR (Gross axle weight rating) .....	5-101
• GVW (Gross vehicle weight) .....	5-101
• GVWR (Gross vehicle weight rating) .....	5-101

امداد خودرو فارما

تلفن شبانه روزی: ۰۲۱-۸۸۸۶۲۰۸۵

FarmaSOS.com

**⚠ WARNING - ENGINE EXHAUST CAN BE DANGEROUS!**

Engine exhaust fumes can be extremely dangerous. If, at any time, you smell exhaust fumes inside the vehicle, open the windows immediately.

**• Do not inhale exhaust fumes.**

Exhaust fumes contain carbon monoxide, a colorless, odorless gas that can cause unconsciousness and death by asphyxiation.

**• Be sure the exhaust system does not leak.**

The exhaust system should be checked whenever the vehicle is raised to change the oil or for any other purpose. If you hear a change in the sound of the exhaust or if you drive over something that strikes the underneath side of the vehicle, we recommend that the system be checked by an authorized HYUNDAI dealer.

**• Do not run the engine in an enclosed area.**

Letting the engine idle in your garage, even with the garage door open, is a hazardous practice. Never run the engine in your garage any longer than it takes to start the engine and back the vehicle out.

**• Avoid idling the engine for prolonged periods with people inside the vehicle.**

If it is necessary to idle the engine for a prolonged period with people inside the vehicle, be sure to do so only in an open area with the air intake set at "Fresh" and fan operating at one of the higher speeds so fresh air is drawn into the interior.

If you must drive with the tailgate open because you are carrying objects that make this necessary:

1. Close all windows.
2. Open side vents.
3. Set the air intake control at "Fresh", the air flow control at "Floor" or "Face" and the fan at one of the higher speeds.

To assure proper operation of the ventilation system, be sure the ventilation air intakes located just in front of the windshield are kept clear of snow, ice, leaves or other obstructions.

## BEFORE DRIVING

### Before entering vehicle

- Be sure that all windows, outside mirror(s), and outside lights are clean.
- Check the condition of the tires.
- Check under the vehicle for any sign of leaks.
- Be sure there are no obstacles behind you if you intend to back up.

### Necessary inspections

Fluid levels, such as engine oil, engine coolant, brake fluid, and washer fluid should be checked on a regular basis, with the exact interval depending on the fluid. Further details are provided in section 7, “Maintenance”.

#### **WARNING**

Driving while distracted can result in a loss of vehicle control, that may lead to an accident, severe personal injury, and death. The driver's primary responsibility is in the safe and legal operation of a vehicle, and use of any handheld devices, other equipment, or vehicle systems which take the driver's eyes, attention and focus away from the safe operation of a vehicle or which are not permissible by law should never be used during operation of the vehicle.

### Before starting

- Close and lock all doors.
- Position the seat so that all controls are easily reached.
- Adjust the inside and outside rearview mirrors.
- Be sure that all lights work.
- Check all gauges.
- Check the operation of warning lights when the ignition switch is turned to the ON position.
- Release the parking brake and make sure the brake warning light goes out.

For safe operation, be sure you are familiar with your vehicle and its equipment.

#### **WARNING**

All passengers must be properly belted whenever the vehicle is moving. Refer to “Seat belts” in section 3 for more information on their proper use.

**⚠ WARNING**

Always check the surrounding areas near your vehicle for people, especially children, before putting a vehicle into D (Drive) or R (Reverse).

**⚠ WARNING - Driving under the influence of alcohol or drugs**

Drinking and driving is dangerous. Drunk driving is the number one contributor to the highway death toll each year. Even a small amount of alcohol will affect your reflexes, perceptions and judgement.

Driving while under the influence of drugs is as dangerous or more dangerous than driving drunk.

You are much more likely to have a serious accident if you drink or take drugs and drive.

If you are drinking or taking drugs, don't drive. Do not ride with a driver who has been drinking or taking drugs. Choose a designated driver or call a cab.

**⚠ WARNING**

- When you intend to park or stop the vehicle with the engine on, be careful not to depress the accelerator pedal for a long period of time. It may overheat the engine or exhaust system and cause fire.
- When you make a sudden stop or turn the steering wheel rapidly, loose objects may drop on the floor and it could interfere with the operation of the foot pedals, possibly causing an accident. Keep all things in the vehicle safely stored.
- If you do not focus on driving, it may cause an accident. Be careful when operating what may disturb driving such as audio or heater. It is the responsibility of the driver to always drive safely.

## KEY POSITIONS

### Illuminated ignition switch (if equipped)

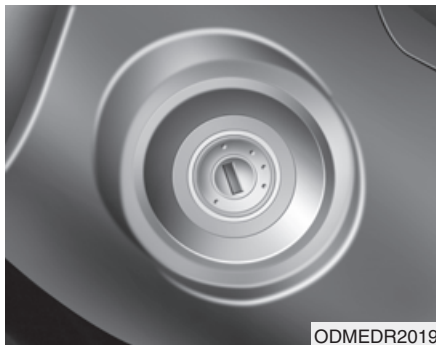

Whenever a front door is opened, the ignition switch will be illuminated for your convenience, provided the ignition switch is not in the ON position. The light will go off immediately when the ignition switch is turned on or go off after about 30 seconds when the door is closed.

### Ignition switch position **LOCK**



The steering wheel locks to protect against theft. The ignition key can be removed only in the LOCK position. When turning the ignition switch to the LOCK position, push the key inward at the ACC position and turn the key toward the LOCK position.

### **ACC (Accessory)**

The steering wheel is unlocked and electrical accessories are operative.

### **\* NOTICE**

If difficulty is experienced turning the ignition switch to the ACC position, turn the key while turning the steering wheel right and left to release the tension.

### **ON**

The warning lights can be checked before the engine is started. This is the normal running position after the engine is started.

*Do not leave the ignition switch ON if the engine is not running to prevent battery discharge.*

### **START**

Turn the ignition switch to the START position to start the engine. The engine will crank until you release the key; then it returns to the ON position. The brake warning light can be checked in this position.

**⚠ WARNING - Ignition key**

- Never turn the ignition switch to LOCK or ACC while the vehicle is moving. This would result in loss of directional control and braking function, which could cause an accident.
- The anti-theft steering column lock is not a substitute for the parking brake. Before leaving the driver's seat, always make sure the shift lever is engaged in 1st gear for the manual transaxle or P (Park) for the automatic transaxle, set the parking brake fully and shut the engine off. Unexpected and sudden vehicle movement may occur if these precautions are not taken.

(Continued)

(Continued)

- Never reach for the ignition switch, or any other controls through the steering wheel while the vehicle is in motion. The presence of your hand or arm in this area could cause a loss of vehicle control, an accident and serious bodily injury or death.
- Do not place any movable objects around the driver's seat as they may move while driving, interfere with the driver and lead to an accident.

FarmaSOS.com

**Starting the engine****⚠ WARNING**

- Always wear appropriate shoes when operating your vehicle. Unsuitable shoes (high heels, ski boots, etc.) may interfere with your ability to use the brake, accelerator and clutch pedal (if equipped).
- Do not start the vehicle with the accelerator pedal depressed. The vehicle can move and lead to an accident.
- Wait until the engine rpm is normal. The vehicle may suddenly move if the brake pedal is released when the rpm is high.



**\* NOTICE - Kick down mechanism (if equipped)**

If your vehicle is equipped with a kick down mechanism in the accelerator pedal, it prevents you from driving at full throttle unintentionally by making the driver require increased effort to depress the accelerator pedal. However, if you depress the pedal more than approximately 80%, the vehicle can be at full throttle and the accelerator pedal will be easier to depress. This is not a malfunction but a normal condition.

**Starting the gasoline engine**

1. Make sure the parking brake is applied.
2. **Manual Transaxle** - Depress the clutch pedal fully and shift the transaxle into Neutral. Keep the clutch pedal and brake pedal depressed while turning the ignition switch to the start position.

**Automatic Transaxle** - Place the transaxle shift lever in P (Park). Depress the brake pedal fully.

*You can also start the engine when the shift lever is in the N (Neutral) position.*

3. Turn the ignition switch to START and hold it there until the engine starts (a maximum of 10 seconds), then release the key.

*Whether the engine is cold or warm, it should be started **without depressing the accelerator pedal.***

4. Do not wait for the engine to warm up while the vehicle remains stationary.

Start driving at moderate engine speeds. (Steep accelerating and decelerating should be avoided.)

 **CAUTION**

*If the engine stalls while you are in motion, do not attempt to move the shift lever to the P (Park) position. If traffic and road conditions permit, you may put the shift lever in the N (Neutral) position while the vehicle is still moving and turn the ignition switch to the START position in an attempt to restart the engine.*

 **CAUTION**

- *Do not engage the starter for more than 10 seconds. If the engine stalls or fails to start, wait 5 to 10 seconds before re-engaging the starter. Improper use of the starter may damage it.*
- *Do not turn the ignition switch to the START position with the engine running. It may damage the starter.*

### Starting the diesel engine

To start the diesel engine when the engine is cold, it has to be pre-heated before starting the engine and then have to be warmed up before starting to drive.

1. Make sure the parking brake is applied.
2. **Manual Transaxle** - Depress the clutch pedal fully and shift the transaxle into Neutral. Keep the clutch pedal and brake pedal depressed while turning the ignition switch to the start position.

**Automatic Transaxle** - Place the transaxle shift lever in P(park). Depress the brake pedal fully.

*You can also start the engine when the shift lever is in the N(neutral) position.*



3. Turn the ignition switch to the ON position to pre-heat the engine. Then the glow indicator light will illuminate.
4. If the glow indicator light goes out, turn the ignition switch to the START position and hold it there until the engine starts (a maximum of 10 seconds), then release the key.

### \* NOTICE

If the engine does not start within 10 seconds after the preheating is completed, turn the ignition key once more to the LOCK position for 10 seconds, and then to the ON position, in order to preheat again.

### Starting and stopping the engine for turbocharger intercooler

1. Do not race or accelerate the engine immediately after starting. If the engine is cold, idle for several seconds before sufficient lubrication is ensured in the turbocharger unit.
2. After high speed or extended driving, requiring a heavy engine load, run the engine on idle condition about 1 minute before turning it off. This idle time will allow the turbocharger to cool prior to shutting the engine off.

### CAUTION

***Do not turn off the engine immediately after it has been subjected to a heavy load. Doing so may cause severe damage to the engine or turbo charger unit.***

## ENGINE START/STOP BUTTON (IF EQUIPPED)

### Illuminated engine start/stop button



Whenever the front door is opened, the engine start/stop button will illuminate for your convenience. The light will go off after about 30 seconds when the door is closed. It will also go off immediately when the theft-alarm system is armed.

### Engine start/stop button position

**OFF**

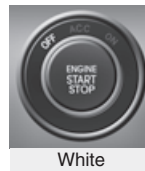

#### With manual transaxle

To turn off the engine (START/RUN position) or vehicle power (ON position), stop the vehicle then press the engine start/stop button.

#### With automatic transaxle

To turn off the engine (START/RUN position) or vehicle power (ON position), press the engine start/stop button with the shift lever in the P (Park) position. When you press the engine start/stop button without the shift lever in the P (Park) position, the engine start/stop button will not change to the OFF position but to the ACC position.

### Vehicles equipped with anti-theft steering column lock

The steering wheel locks when the engine start/stop button is in the OFF position to protect you against theft.

It locks when the door is opened.

If the steering wheel is not locked properly when you open the driver's door, the warning chime will sound. Try locking the steering wheel again. If the problem is not solved, we recommend that the system be checked by an authorized HYUNDAI dealer.

In addition, if the engine start/stop button is in the OFF position after the driver's door is opened, the steering wheel will not lock and the warning chime will sound. In such a situation, close the door. Then the steering wheel will lock and the warning chime will stop.

**\* NOTICE**

If the steering wheel doesn't unlock properly, the engine start/stop button will not work. Press the engine start/stop button while turning the steering wheel right and left to release the tension.

**\* NOTICE**

You are able to turn off the engine (START/RUN) or vehicle power (ON), only when the vehicle is not in motion.

**⚠ CAUTION**

*In an emergency situation while the vehicle is in motion, you are able to turn the engine off and to the ACC position by pressing the engine start/stop button for more than 2 seconds or 3 times successively within 3 seconds. If the vehicle is still moving, you can restart the engine without depressing the brake pedal by pressing the engine start/stop button with the shift lever in the N (Neutral) position.*

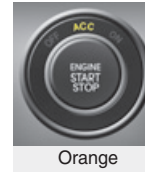
**ACC(Accessory)**

Orange

**With manual transaxle**

Press the engine start/stop button when the button is in the OFF position without depressing the clutch pedal.

**With automatic transaxle**

Press the engine start/stop button while it is in the OFF position without depressing the brake pedal.

The steering wheel unlocks and electrical accessories are operational.

If the engine start/stop button is in the ACC position for more than 1 hour, the button is turned off automatically to prevent battery discharge.

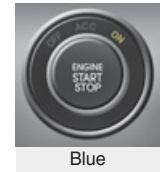
**ON**

Blue

**With manual transaxle**

Press the engine start/stop button when the button is in the ACC position without depressing the clutch pedal.

**With automatic transaxle**

Press the engine start/stop button while it is in the ACC position without depressing the brake pedal.

The warning lights can be checked before the engine is started. Do not leave the engine start/stop button in the ON position for a long time. The battery may discharge, because the engine is not running.

## START/RUN



Not illuminated

### With manual transaxle

To start the engine, depress the clutch pedal and brake pedal, then press the engine start/stop button with the shift lever in the N (Neutral) position.

### With automatic transaxle

To start the engine, depress the brake pedal and press the engine start/stop button with the shift lever in the P (Park) or the N (Neutral) position. For your safety, start the engine with the shift lever in the P (Park) position.

## \* NOTICE

If you press the engine start/stop button without depressing the clutch pedal for manual transaxle vehicles or without depressing the brake pedal for automatic transaxle vehicles, the engine will not start and the engine start/stop button changes as follow:

OFF → ACC → ON → OFF or ACC

## \* NOTICE

If you leave the engine start/stop button in the ACC or ON position for a long time, the battery will discharge.

## ⚠ WARNING

- Never press the engine start/stop button while the vehicle is in motion. This would result in loss of directional control and braking function, which could cause an accident.
- The anti-theft steering column lock is not a substitute for the parking brake. Before leaving the driver's seat, always make sure the shift lever is engaged in P (Park), set the parking brake fully and shut the engine off. Unexpected and sudden vehicle movement may occur if these precautions are not taken.

(Continued)

FarmaSOS.com

(Continued)

- Never reach for the engine start/ stop button or any other controls through the steering wheel while the vehicle is in motion. The presence of your hand or arm in the area could cause loss of vehicle control, an accident and serious bodily injury or death.
- Do not place any movable objects around the driver's seat as they may move while driving, interfere with the driver and lead to an accident.

### Starting the engine

#### WARNING

- Always wear appropriate shoes when operating your vehicle. Unsuitable shoes (high heels, ski boots, etc.) may interfere with your ability to use the brake, accelerator and clutch pedal.
- Do not start the vehicle with the accelerator pedal depressed. The vehicle can move and lead to an accident.
- Wait until the engine rpm is normal. The vehicle may suddenly move if the brake pedal is released when the rpm is high.

#### \* NOTICE - Kick down mechanism (if equipped)

If your vehicle is equipped with a kick down mechanism in the accelerator pedal, it prevents you from driving at full throttle unintentionally by making the driver require increased effort to depress the accelerator pedal. However, if you depress the pedal more than approximately 80%, the vehicle can be at full throttle and the accelerator pedal will be easier to depress. This is not a malfunction but a normal condition.

### **Starting the gasoline engine**

1. Carry the smart key or leave it inside the vehicle.
2. Make sure the parking brake is firmly applied.

3. **Manual Transaxle** - Depress the clutch pedal fully and shift the transaxle into Neutral. Keep the clutch pedal and brake pedal depressed while starting the engine.

**Automatic Transaxle** - Place the transaxle shift lever in P (Park). Depress the brake pedal fully.

*You can also start the engine when the shift lever is in the N (Neutral) position.*

4. Press the engine start/stop button. Whether the engine is cold or warm, it should be started without depressing the accelerator pedal.
5. Do not wait for the engine to warm up while the vehicle remains stationary.

Start driving at moderate engine speeds. (Steep accelerating and decelerating should be avoided.)

### **Starting the diesel engine**

To start the diesel engine when the engine is cold, it has to be pre-heated before starting the engine and then have to be warmed up before starting to drive.

1. Make sure the parking brake is applied.
2. **Manual Transaxle** - Depress the clutch pedal fully and shift the transaxle into Neutral. Keep the clutch pedal and brake pedal depressed while pressing the engine start/stop button to the START position.

**Automatic Transaxle** - Place the transaxle shift lever in P (Park). Depress the brake pedal fully.

*You can also start the engine when the shift lever is in the N (Neutral) position.*

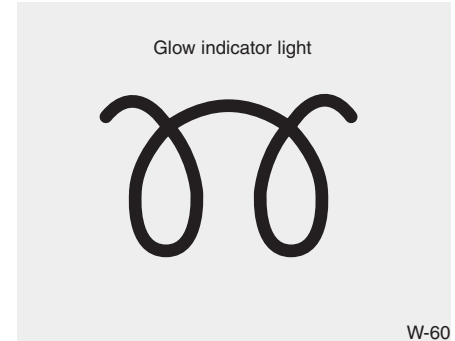

3. Press the engine start/stop button while depressing the brake pedal.
4. Continue depressing the brake pedal until the illuminated glow indicator goes off. (approximately 5 seconds)
5. The engine starts running when the glow indicator goes off.

### **\* NOTICE**

**If the engine start/stop button is pressed once more while the engine is pre-heating, the engine may start.**

### Starting and stopping the engine for turbocharger intercooler

1. Do not race or accelerate the engine immediately after starting.

If the engine is cold, idle for several seconds before sufficient lubrication is ensured in the turbocharger unit.

2. After high speed or extended driving, requiring a heavy engine load, idle the engine about 1 minute before turning it off.

This idle time will allow the turbocharger to cool prior to shutting the engine off.

#### CAUTION

*Do not turn the engine off immediately after it has been subjected to a heavy load. Doing so may cause severe damage to the engine or turbocharger unit.*

- Even if the smart key is in the vehicle, if it is far away from you, the engine may not start.
- When the engine start/stop button is in the ACC position or above, if any door is opened, the system checks for the smart key. If the smart key is not in the vehicle, the “” indicator and a message “Key not in vehicle” will appear on the instrument cluster and LCD display. And if all doors are closed, the chime will sound for 5 seconds. The indicator or warning will turn off while the vehicle is moving. Always have the smart key with you.

#### WARNING

The engine will start, only when the smart key is in the vehicle. Never allow children or any person who is unfamiliar with the vehicle touch the engine start/stop button or related parts.

#### CAUTION

*If the engine stalls while the vehicle is in motion, do not attempt to move the shift lever to the P (Park) position. If the traffic and road conditions permit, you may put the shift lever in the N (Neutral) position while the vehicle is still moving and press the engine start/stop button in an attempt to restart the engine.*





(Continued)

The side with the lock button should contact the engine start/stop button directly. When you press the engine start/stop button directly with the smart key, the smart key should contact the button at a right angle.

- When the stop lamp fuse is blown, you cannot start the engine normally.

Replace the fuse with a new one. If it is not possible, you can start the engine by pressing the engine start/stop button for 10 seconds while it is in the ACC position. The engine can start without depressing the brake pedal. But for your safety always depress the brake pedal and clutch pedal (if equipped) before starting the engine.

**⚠ CAUTION**

- Do not press the engine start/stop button for more than 10 seconds except when the stop lamp fuse is blown.
- Do not turn the ignition switch to the START position with the engine running. It may damage the starter.

**\* NOTICE**

- If the battery is weak or the smart key does not work correctly, you can start the engine by pressing the engine start/stop button with the smart key.

(Continued)

## MANUAL TRANSAXLE (IF EQUIPPED)

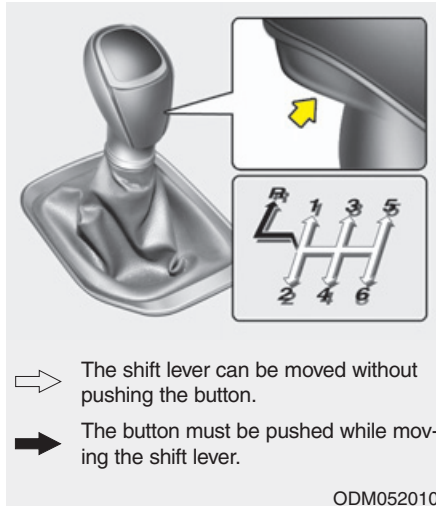

ODM052010

### Manual transaxle operation

- The manual transaxle has 6 forward gears.

This shift pattern is imprinted on the shift knob. The transaxle is fully synchronized in all forward gears so shifting to either a higher or a lower gear is easily accomplished.

- Depress the clutch pedal down fully while shifting, then release it slowly.

If your vehicle is equipped with an ignition lock switch, the engine will not start when starting the engine without depressing the clutch pedal.

- The shift lever must return to the neutral position before shifting into R (Reverse). The button located immediately below the shift knob must be pushed upward while moving the shift lever to the R (Reverse) position.
- *Make sure the vehicle is completely stopped before shifting into R (Reverse).*

*Never operate the engine with the tachometer (rpm) in the red zone.*

### ⚠ CAUTION

- *When downshifting from 5 (Fifth) gear to 4 (Fourth) gear, caution should be taken not to inadvertently move the shift lever sideways in such a manner that second gear is engaged. Such a drastic downshift may cause the engine speed to increase to the point that the tachometer will enter the red-zone. Such over-revving of the engine may possibly cause engine and transaxle damage.*
- *Do not downshift more than 2 gears or downshift the gear when the engine is running at high speed (5,000 RPM or higher). Such a downshifting may damage the engine, clutch and the transaxle.*

- During cold weather, shifting may be difficult until the transaxle lubricant has warmed up. This is normal and not harmful to the transaxle.
- If you've come to a complete stop and it's hard to shift into 1 (First) or R (Reverse), put the shift lever in neutral position and release the clutch. Press the clutch pedal back down, and then shift into 1 (First) or R (Reverse) gear position.

### CAUTION

- *To avoid premature clutch wear and damage, do not drive with your foot resting on the clutch pedal. Also, don't use the clutch to hold the vehicle stopped on an uphill grade, while waiting for a traffic light, etc.*
- *Do not use the shift lever as a handrest during driving, as this can result in premature wear of the transaxle shift forks.*
- *To prevent possible damage to the clutch system, do not start with the 2nd (second) gear engaged except when you start on a slippery road.*

### WARNING

- Before leaving the driver's seat, always set the parking brake fully and shut the engine off. Then make sure the transaxle is shifted into 1 (First) gear when the vehicle is parked on a level or uphill grade, and shifted into R (Reverse) on a downhill grade. Unexpected and sudden vehicle movement can occur if these precautions are not followed in the order identified.
- If your vehicle has a manual transaxle not equipped with a ignition lock switch, it may move and cause a serious accident when starting the engine without depressing the clutch pedal while the parking brake is released and the shift lever not in the neutral position.
- Do not use the engine brake (shifting from a high gear to lower gear) rapidly on slippery roads. The vehicle may slip causing an accident.

### Using the clutch

The clutch pedal should be depressed all the way to the floor before shifting, then released slowly. The clutch pedal should always be fully released while driving. Do not rest your foot on the clutch pedal while driving. This can cause unnecessary wear. Do not partially engage the clutch to hold the vehicle on an incline. This causes unnecessary wear. Use the foot brake or parking brake to hold the vehicle on an incline. Do not operate the clutch pedal rapidly and repeatedly.

#### CAUTION

***When operating the clutch pedal, depress the clutch pedal down fully. If you don't depress the clutch pedal fully, the clutch may be damaged or noise may occur.***

### Downshifting

When you must slow down in heavy traffic or while driving up steep hills, downshift before the engine starts to labor. Downshifting reduces the chance of stalling and gives better acceleration when you again need to increase your speed. When the vehicle is traveling down steep hills, downshifting helps maintain safe speed and prolongs brake life.

تلفن شبانه روزی: ۰۲۱-۸۸۸۶۲۰۸۵

FarmaSOS.com

### Good driving practices

- Never take the vehicle out of gear and coast down a hill. This is extremely hazardous. Always leave the vehicle in gear.
- Don't "ride" the brakes. This can cause them to overheat and malfunction. Instead, when you are driving down a long hill, slow down and shift to a lower gear. When you do this, engine braking will help slow down the vehicle.
- Slow down before shifting to a lower gear. This will help avoid over-revving the engine, which can cause damage.
- Slow down when you encounter cross winds. This gives you much better control of your vehicle.
- Be sure the vehicle is completely stopped before you attempt to shift into R (Reverse). The transaxle can be damaged if you do not. To shift into R (Reverse), depress the clutch, move the shift lever to neutral, wait three seconds, then shift to the R (Reverse) position.

- Exercise extreme caution when driving on a slippery surface. Be especially careful when braking, accelerating or shifting gears. On a slippery surface, an abrupt change in vehicle speed can cause the drive wheels to lose traction and the vehicle to go out of control.

### **⚠ WARNING**

- **Always buckle-up!** In a collision, an unbelted occupant is significantly more likely to be seriously injured or killed than a properly belted occupant.
- **Avoid high speeds when cornering or turning.**
- **Do not make quick steering wheel movements, such as sharp lane changes or fast, sharp turns.**
- **The risk of rollover is greatly increased if you lose control of your vehicle at highway speeds.**
- **Loss of control often occurs if two or more wheels drop off the roadway and the driver oversteers to reenter the roadway.**

**(Continued)**

### **(Continued)**

- **In the event your vehicle leaves the roadway, do not steer sharply. Instead, slow down before pulling back into the travel lanes.**
- **Never exceed posted speed limits.**

## AUTOMATIC TRANSAXLE (IF EQUIPPED)

### ■ Type A

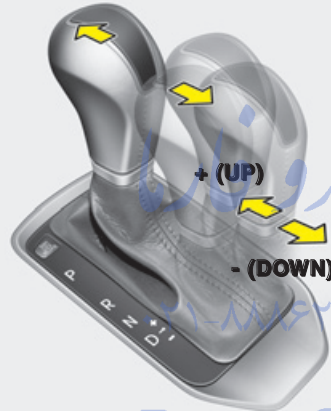
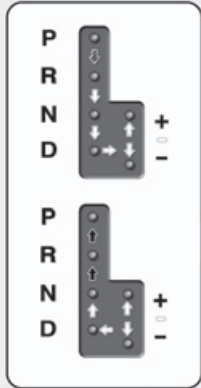

### ■ Type B

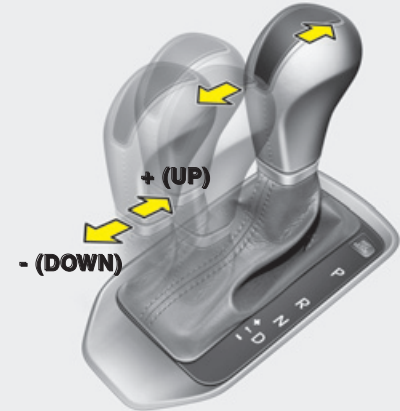
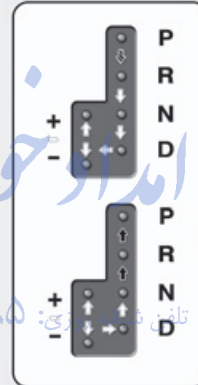

Depress the brake pedal and the lock release button when shifting.

(If the shift lock system is not equipped, it is not necessary to depress the brake pedal. However, it is recommended to depress the brake pedal to avoid inadvertent movement of the vehicle.)



Press the lock release button when shifting.



The shift lever can be shifted freely.

FarmaSOS.com

ODM052011/ODMEDR2203R

### Automatic transaxle operation

The highly efficient automatic transaxle has 6 forward speeds and one reverse speed. The individual speeds are selected automatically, depending on the position of the shift lever.

### \* NOTICE

The first few shifts on a new vehicle, if the battery has been disconnected, may be somewhat abrupt. This is a normal condition, and the shifting sequence will adjust after shifts are cycled a few times by the TCM (Transaxle Control Module) or PCM (Powertrain Control Module).

*For smooth operation, depress the brake pedal when shifting from N (Neutral) to a forward or reverse gear.*

### WARNING - Automatic transaxle

- Always check the surrounding areas near your vehicle for people, especially children, before shifting a vehicle into D (Drive) or R (Reverse).
- Before leaving the driver's seat, always make sure the shift lever is in the P (Park) position; then set the parking brake fully and shut the engine off. Unexpected and sudden vehicle movement can occur if these precautions are not followed in the order identified.
- Do not use the engine brake (shifting from a high gear to lower gear) rapidly on slippery roads. The vehicle may slip causing an accident.

### CAUTION

- To avoid damage to your transaxle, do not accelerate the engine in R (Reverse) or any forward gear position with the brakes on.
- When stopped on an upgrade, do not hold the vehicle stationary with engine power. Use the service brake or the parking brake.
- Do not shift from N (Neutral) or P (Park) into D (Drive), or R (Reverse) when the engine is above idle speed.

**Transaxle ranges**

The indicator lights in the instrument cluster displays the shift lever position when the ignition switch is in the ON position.

**P (Park)**

Always come to a complete stop before shifting into P (Park). This position locks the transaxle and prevents the front wheels from rotating.

**⚠ WARNING**

- Shifting into P (Park) while the vehicle is in motion will cause the drive wheels to lock which will cause you to lose control of the vehicle.
- Do not use the P (Park) position in place of the parking brake. Always make sure the shift lever is latched in the P (Park) position and set the parking brake fully.
- Never leave a child unattended in a vehicle.

**⚠ CAUTION**

*The transaxle may be damaged if you shift into P (Park) while the vehicle is in motion.*

**R (Reverse)**

Use this position to drive the vehicle backward.

**⚠ CAUTION**

*Always come to a complete stop before shifting into or out of R (Reverse); you may damage the transaxle if you shift into R (Reverse) while the vehicle is in motion, except as explained in "Rocking the vehicle", in this manual.*

**N (Neutral)**

The wheels and transaxle are not engaged. The vehicle will roll freely even on the slightest incline unless the parking brake or service brakes are applied.

**⚠ WARNING**

**Do not drive with the shift lever in N (Neutral).**

**The engine brake will not work and lead to an accident.**



### D (Drive)

This is the normal forward driving position. The transaxle will automatically shift through a 6-gear sequence, providing the best fuel economy and power.

For extra power when passing another vehicle or climbing grades, depress the accelerator pedal fully (more than 80%) until the kick down mechanism works with a clicking noise, at which time the transaxle will automatically downshift to the next lower gear.

### \* NOTICE

- Always come to a complete stop before shifting into D (Drive).
- A clicking noise heard from the kick down mechanism by depressing the accelerator pedal fully is a normal condition.

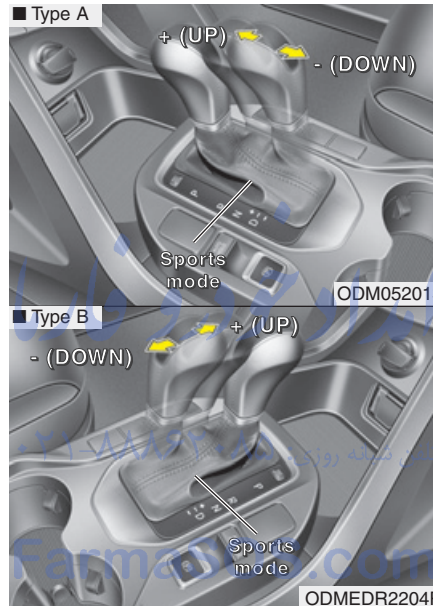

### Sports mode

Whether the vehicle is stationary or in motion, sports mode is selected by pushing the shift lever from the D (Drive) position into the manual gate. To return to D (Drive) range operation, push the shift lever back into the main gate.

In sports mode, moving the shift lever backwards and forwards will allow you to make gearshifts rapidly. In contrast to a manual transaxle, the sports mode allows gearshifts with the accelerator pedal depressed.

Up (+) : Push the lever forward once to shift up one gear.

Down (-) : Pull the lever backwards once to shift down one gear.

### \* NOTICE

- In sports mode, the driver must execute upshifts in accordance with road conditions, taking care to keep the engine speed below the red zone.
- In sports mode, only the 6 forward gears can be selected. To reverse or park the vehicle, move the shift lever to the R (Reverse) or P (Park) position as required.

(Continued)

(Continued)

- In sports mode, downshifts are made automatically when the vehicle slows down. When the vehicle stops, 1st gear is automatically selected.
- In sports mode, when the engine rpm approaches the red zone shift points are varied to upshift automatically.
- To maintain the required levels of vehicle performance and safety, the system may not execute certain gearshifts when the shift lever is operated.
- When driving on a slippery road, push the shift lever forward into the +(up) position. This causes the transaxle to shift into the 2nd gear which is better for smooth driving on a slippery road. Push the shift lever to the -(down) side to shift back to the 1st gear.

### **Shift lock system**

For your safety, the automatic transaxle has a shift lock system which prevents shifting the transaxle from P (Park) or N (Neutral) into R (Reverse) unless the brake pedal is depressed.

To shift the transaxle from P (Park) or N (Neutral) into R (Reverse):

1. Depress and hold the brake pedal.
2. Start the engine or turn the ignition switch to the ON position.
3. Move the shift lever.

If the brake pedal is repeatedly depressed and released, with the shift lever in the P (Park) position, a chattering noise near the shift lever may be heard. This is a normal condition.

### **⚠ WARNING**

**Always fully depress the brake pedal before and while shifting out of the P (Park) position into another position to avoid inadvertent motion of the vehicle which could injure persons in or around the vehicle.**

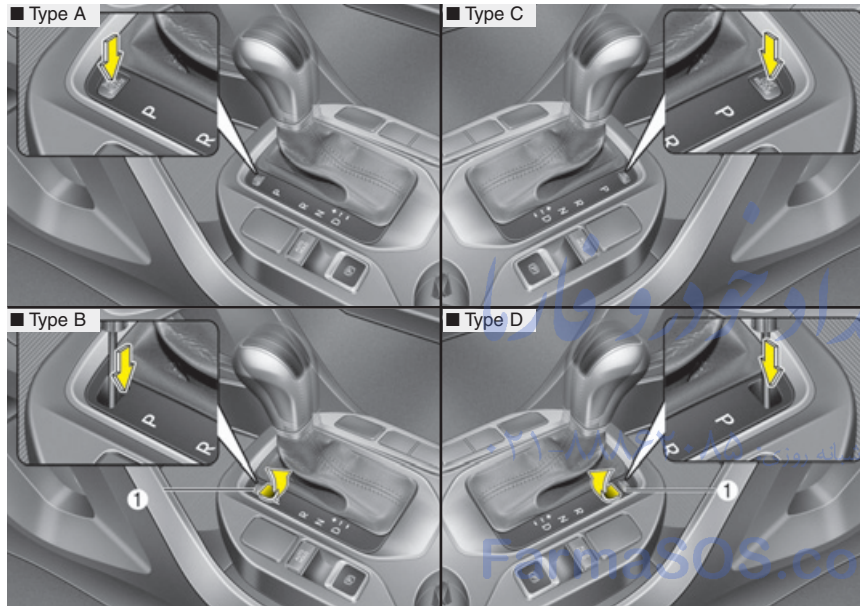

ODM052012/ODM053014/ODMEDR2205R/ODMEDR3206R

### Shift-lock override

If the shift lever cannot be moved from the P (Park) or N (Neutral) position into R (Reverse) position with the brake pedal depressed, continue depressing the brake, then do the following:

### Type A, C

1. Press the shift-lock release button.
2. Move the shift lever.
3. We recommend that the system be inspected by an authorized HYUNDAI dealer.

### Type B, D

1. Carefully remove the cap (1) covering the shift-lock override access hole.
2. Insert a screwdriver into the access hole and press down on the screwdriver.
3. Move the shift lever.
4. We recommend that the system be inspected by an authorized HYUNDAI dealer.

### Ignition key interlock system (if equipped)

The ignition key cannot be removed unless the shift lever is in the P (Park) position.

## Good driving practices

- Never move the shift lever from P (Park) or N (Neutral) to any other position with the accelerator pedal depressed.
- Never move the shift lever into P (Park) when the vehicle is in motion.
- Be sure the vehicle is completely stopped before you attempt to shift into R (Reverse) or D (Drive).
- Never take the vehicle out of gear and coast down a hill. This may be extremely hazardous. Always leave the vehicle in gear when moving.
- Do not "ride" the brakes. This can cause them to overheat and malfunction. Instead, when you are driving down a long hill, slow down and shift to a lower gear. When you do this, engine braking will help slow down the vehicle.
- Slow down before shifting to a lower gear. Otherwise, the lower gear may not be engaged.

- Always use the parking brake. Do not depend on placing the transaxle in P (Park) to keep the vehicle from moving.
- Exercise extreme caution when driving on a slippery surface. Be especially careful when braking, accelerating or shifting gears. On a slippery surface, an abrupt change in vehicle speed can cause the drive wheels to lose traction and the vehicle to go out of control.
- Optimum vehicle performance and economy is obtained by smoothly depressing and releasing the accelerator pedal.

FarmaSOS.com

## WARNING

- **Always buckle-up!** In a collision, an unbelted occupant is significantly more likely to be seriously injured or killed than a properly belted occupant.
- **Avoid high speeds when cornering or turning.**
- **Do not make quick steering wheel movements, such as sharp lane changes or fast, sharp turns.**
- **The risk of rollover is greatly increased if you lose control of your vehicle at highway speeds.**
- **Loss of control often occurs if two or more wheels drop off the roadway and the driver oversteers to reenter the roadway.**
- **In the event your vehicle leaves the roadway, do not steer sharply. Instead, slow down before pulling back into the travel lanes.**
- **Never exceed posted speed limits.**

**⚠ WARNING**

If your vehicle becomes stuck in snow, mud, sand, etc., then you may attempt to rock the vehicle free by moving it forward and backward. Do not attempt this procedure if people or objects are anywhere near the vehicle. During the rocking operation the vehicle may suddenly move forward or backward as it becomes unstuck, causing injury or damage to nearby people or objects.

***Moving up a steep grade from a standing start***

To move up a steep grade from a standing start, depress the brake pedal, shift the shift lever to D (Drive). Select the appropriate gear depending on load weight and steepness of the grade, and release the parking brake. Depress the accelerator gradually while releasing the service brakes.

تلفن شبانه روزی: ۰۲۱-۸۸۸۶۲۰۸۵

FarmaSOS.com

## FOUR WHEEL DRIVE (4WD) (IF EQUIPPED)

Engine power can be delivered to all front and rear wheels for maximum traction. 4WD is useful when extra traction is required, such as, when driving on slippery, muddy, wet, or snow-covered roads. These vehicles are not designed for challenging off-road use. Occasional off-road use such as established unpaved roads and trails are OK. It is always important when traveling off-highway that the driver carefully reduces the speed to a level that does not exceed the safe operating speed for those conditions. In general, off-road conditions provide less traction and braking effectiveness than normal road conditions. The driver must be especially alert to avoid driving on slopes which tilt the vehicle to either side.

These factors must be carefully considered when driving off-road. Keeping the vehicle in contact with the driving surface and under control in these conditions is always the driver's responsibility for the safety of him/herself and his or her passengers.

### **WARNING - Off road driving**

**This vehicle is designed primarily for on road use although it can operate effectively off road. However, it was not designed to drive in challenging off-road conditions. Driving in conditions that exceed the vehicle's intended design or the driver's experience level may result in severe injury or death.**

### **WARNING**

**If the 4WD system warning light (  ) illuminates, this indicates that there is a malfunction in the 4WD system.**

**If this occurs, we recommend that the system be checked by an authorized HYUNDAI dealer.**

## Tight corner brake effect





### **CAUTION - 4WD**

***When turning sharply on a paved road at low speed while in four-wheel drive, steering control will be difficult.***

Tight corner brake effect is a unique characteristic of four-wheel drive vehicles caused by the difference in tire rotation at the four wheels and the zero-degree alignment of the front wheels and suspension.

Sharp turns at low speeds should be carried out with caution.

### Four Wheel Drive (4WD) transfer mode selection

Transfer mode	Selection button	Indicator light	Description
<b>4WD AUTO</b> (4WD LOCK is deactivated)		 (Indicator light is not illuminated)	<ul style="list-style-type: none"> <li>When driving in 4WD AUTO mode, the vehicle operates similar to conventional 2WD vehicles under normal operating conditions. However, if the system determines that there is a need for the 4WD mode, the engine's driving power is distributed to all four wheels automatically without driver intervention.</li> <li>When driving on normal roads and pavement, the vehicle moves similar to conventional 2WD vehicles.</li> </ul>
<b>4WD LOCK</b>		 (Indicator light is illuminated)	<ul style="list-style-type: none"> <li>This mode is used for climbing or descending sharp grades, off-road driving, driving on sandy and muddy roads, etc., to maximize traction.</li> <li>This mode automatically begins to deactivate at speeds above 30 km/h (19 mph) and is shifted to 4WD AUTO mode at speed above 40 km/h (25 mph). If the vehicle decelerates to speeds below 30 km/h (19 mph), however, the transfer mode is shifted into 4WD LOCK mode again.</li> </ul>

#### \* NOTICE

- When driving on normal roads, deactivate the 4WD LOCK mode by pushing the 4WD LOCK button (the indicator light goes off). Driving on normal roads with 4WD LOCK mode (especially, when cornering) may cause mechanical noise or vibration. The noise and vibration will disappear when the 4WD LOCK mode is deactivated. Some parts of the power train may be damaged by prolonged driving with the noise and vibration.
- When the 4WD LOCK mode is deactivated, a shock may be felt as the drive power is delivered entirely to the front wheels. This shock is not a mechanical failure.

## For safe four-wheel drive operation

### **⚠ WARNING - Four-wheel driving**

The conditions of on-road or off-road that demand four-wheel drive mean all functions of your vehicle are exposed to extreme stress than under normal road conditions. Slow down and be ready for changes in the composition and traction of the surface under your tires. If you have any doubt about the safety of the conditions you are facing, stop and consider the best way to proceed. Do not exceed the ability of yourself or your vehicle to operate safely.

- Do not try to drive in deep standing water or mud since such conditions can stall your engine and clog your exhaust pipes. Do not drive down steep hills since it requires extreme skill to maintain control of the vehicle.



- When you are driving up or down hills drive as straight as possible. Use extreme caution in going up or down steep hills, since you may flip your vehicle over depending on the grade, terrain and water/mud conditions.

FarmaSOS.com

### **⚠ WARNING - Hills**

Driving across the contour of steep hills can be extremely dangerous. This danger can come from slight changes in the wheel angle which can destabilize the vehicle or, even if the vehicle is maintaining stability under power, it can lose that stability if the vehicle stops its forward motion. Your vehicle may roll over without warning and without time for you to correct a mistake that could cause serious injury or death.



- You must consciously take the effort to learn how to corner in a 4WD vehicle. Do not rely on your experience in conventional 2WD vehicles in choosing safe cornering speed in 4WD mode. For starters, you must drive more slowly in 4WD.
- Drive carefully off-road because your vehicle may be damaged by rocks or roots of trees. Become familiar with the off-road conditions where you are going to drive before you begin driving.

### **⚠ WARNING - 4WD**

Reduce speed when you turn corners. The center of gravity of 4WD vehicles is higher than that of conventional 2WD vehicles, making them more likely to roll over when you turn corners too fast.



ODMEDR2146

### **⚠ WARNING - Steering wheel**

Do not grab the inside of the steering wheel when you are driving off-road. You may hurt your arm by a sudden steering maneuver or from steering wheel rebound due to impact with objects on the ground. You could lose control of the steering wheel.

- Always hold the steering wheel firmly when you are driving off-road.
- Make sure all passengers are wearing seat belts.

### **⚠ WARNING - Wind danger**

If you are driving in heavy wind, the vehicle's higher center of gravity decreases your steering control capacity and requires you to drive more slowly.

- If you need to drive in the water, stop your vehicle, set your transfer to the 4WD LOCK mode and drive at less than 8 km/h (5 mph).

**⚠ WARNING - Driving through water**

Drive slowly. If you are driving too fast in water, the water can get into the engine compartment and wet the ignition system, causing your vehicle to suddenly stop. If this happens and your vehicle is in a tilted position, your vehicle may roll over.

**\* NOTICE**

- Do not drive in water if the level is higher than the bottom of the vehicle.
- Check your brake condition once you are out of mud or water. Press the brake pedal several times as you move slowly until you feel normal braking forces return.
- Shorten your scheduled maintenance interval if you drive in off-road conditions such as sand, mud or water (see “Maintenance under severe usage conditions” in section 7). Always wash your vehicle thoroughly after off road use, especially cleaning the bottom of the vehicle.
- Since the driving torque is always applied to the 4 wheels the performance of the 4WD vehicle is greatly affected by the condition of the tires. Be sure to equip the vehicle with four tires of the same size and type.
- A full time four wheel drive vehicle cannot be towed by an ordinary tow truck. Make sure that the vehicle is placed on a flat bed truck for moving.

**⚠ WARNING - 4WD driving**

- Avoid high cornering speed.
- Do not make quick steering wheel movements, such as sharp lane changes or fast, sharp turns.
- The risk of rollover is greatly increased if you lose control of your vehicle at high speed.
- In a collision, an unbelted person is significantly more likely to die compared to a person wearing a seat belt.
- Loss of control often occurs if two or more wheels drop off the roadway and the driver over steers to re-enter the roadway. In the event your vehicle leaves the roadway, do not steer sharply. Instead, slow down before pulling back into the travel lanes.

**⚠ CAUTION - Mud or snow**  
*If one of the front or rear wheels begins to spin in mud, snow, etc. the vehicle can sometimes be driven out by depressing the accelerator pedal further; however avoid running the engine continuously at high rpm because doing so could damage the 4WD system.*

### Reducing the risk of a rollover

This multi-purpose passenger vehicle is defined as a Sports Utility Vehicle (SUV). SUV's have higher ground clearance and a narrower track to make them capable of performing in a wide variety of off-road applications. Specific design characteristics give them a higher center of gravity than ordinary vehicles. An advantage of the higher ground clearance is a better view of the road, which allows you to anticipate problems. They are not designed for cornering at the same speeds as conventional passenger vehicles, any more than low-slung sports cars are designed to perform satisfactorily in off-road conditions. Due to this risk, driver and passengers are strongly recommended to buckle their seat belts. In a rollover crash, an unbelted person is more likely to die than a person wearing a seat belt. There are steps that a driver can make to reduce the risk of a rollover. If at all possible, avoid sharp turns or abrupt maneuvers, do not load your roof rack with heavy cargo, and never modify your vehicle in any way.

**⚠ WARNING - Rollover**  
As with other Sports Utility Vehicle (SUV), failure to operate this vehicle correctly may result in loss of control, an accident or vehicle rollover.

- Utility vehicles have a significantly higher rollover rate than other types of vehicles.
- Specific design characteristics (higher ground clearance, narrower track, etc.) give this vehicle a higher center of gravity than ordinary vehicles.
- A SUV is not designed for cornering at the same speeds as conventional vehicles.
- Avoid sharp turns or abrupt maneuvers.
- In a rollover crash, an unbelted person is significantly more likely to die than a person wearing a seat belt. Make sure everyone in the vehicle is properly buckled up.

**⚠ WARNING**

Your vehicle is equipped with tires designed to provide safe ride and handling capability. Do not use a size and type of tire and wheel that is different from the one that is originally installed on your vehicle. It can affect the safety and performance of your vehicle, which could lead to steering failure or rollover and serious injury. When replacing the tires, be sure to equip all four tires with the tire and wheel of the same size, type, tread, brand and load-carrying capacity. If you nevertheless decide to equip your vehicle with any tire/wheel combination not recommended by HYUNDAI for off road driving, you should not use these tires for highway driving.

**⚠ WARNING - Jacked vehicle**

While a full-time 4WD vehicle is being raised on a jack, never start the engine or cause the tires to rotate.

There is a danger that rotating tires touching the ground could cause the vehicle to fall off the jack and to jump forward or rearward.

تلفن شبانه روزی: ۰۲۱-۸۸۸۶۲۰۸۵

FarmaSOS.com

- Full-time 4WD vehicles must be tested on a special four wheel chassis dynamometer.

**\* NOTICE**

Never engage the parking brake while performing these tests.

- A full-time 4WD vehicle should not be tested on a 2WD roll tester. If a 2WD roll tester must be used, perform the following:

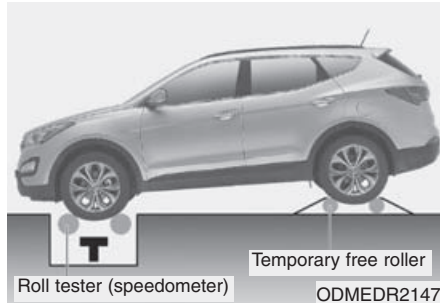

1. Check the tire pressures recommended for your vehicle.
2. Place the front wheels on the roll tester for a speedometer test as shown in the illustration.
3. Release the parking brake.
4. Place the rear wheels on the temporary free roller as shown in the illustration.

### **⚠ WARNING - Dynamometer testing**

Keep away from the front of the vehicle while the vehicle is in gear on the dynamometer. This is very dangerous as the vehicle can jump forward and cause serious injury or death.

### **⚠ CAUTION**

- *When lifting up the vehicle, do not operate front and rear wheel separately. All four wheels should be operated.*
- *If you need to operate the front wheel and rear wheel when lifting up the vehicle, you should release the parking brake.*

## BRAKE SYSTEM

### Power brakes

Your vehicle has power-assisted brakes that adjust automatically through normal usage.

In the event that the power-assisted brakes lose power because of a stalled engine or some other reason, you can still stop your vehicle by applying greater force to the brake pedal than you normally would. The stopping distance, however, will be longer.

When the engine is not running, the reserve brake power is partially depleted each time the brake pedal is applied. Do not pump the brake pedal when the power assist has been interrupted.

Pump the brake pedal only when necessary to maintain steering control on slippery surfaces.

### **WARNING - Brakes**

- Do not drive with your foot resting on the brake pedal. This will create abnormal high brake temperatures, excessive brake lining and pad wear, and increased stopping distances.
- When descending a long or steep hill, shift to a lower gear and avoid continuous application of the brakes. Continuous brake application will cause the brakes to overheat and could result in a temporary loss of braking performance.
- Wet brakes may impair the vehicle's ability to safely slow down; the vehicle may also pull to one side when the brakes are applied. Applying the brakes lightly will indicate whether they have been affected in this way. Always test your brakes in this fashion after driving through deep water.

(Continued)

(Continued)

To dry the brakes, apply them lightly while maintaining a safe forward speed until brake performance returns to normal.

- Always, confirm the position of the brake and accelerator pedal before driving. If you don't check the position of the accelerator and brake pedal before driving, you may depress the accelerator instead of the brake pedal. It may cause a serious accident.

### ***In the event of brake failure***

If service brakes fail to operate while the vehicle is in motion, you can make an emergency stop with the parking brake. The stopping distance, however, will be much greater than normal.

#### **⚠ WARNING - Parking brake**

**Applying the parking brake while the vehicle is moving at normal speeds can cause a sudden loss of control of the vehicle. If you must use the parking brake to stop the vehicle, use great caution in applying the brake.**

### ***Disc brakes wear indicator***

When your brake pads are worn and new pads are required, you will hear a high-pitched warning sound from your front brakes or rear brakes. You may hear this sound come and go or it may occur whenever you depress the brake pedal.

Please remember that some driving conditions or climates may cause a brake squeal when you first apply (or lightly apply) the brakes. This is normal and does not indicate a problem with your brakes.

#### **⚠ CAUTION**

- ***To avoid costly brake repairs, do not continue to drive with worn brake pads.***
- ***Always replace the front or rear brake pads as pairs.***

#### **⚠ WARNING - Brake wear**

**This brake wear warning sound means your vehicle needs service. If you ignore this audible warning, you will eventually lose braking performance, which could lead to a serious accident.**

## Parking brake

### Applying the parking brake

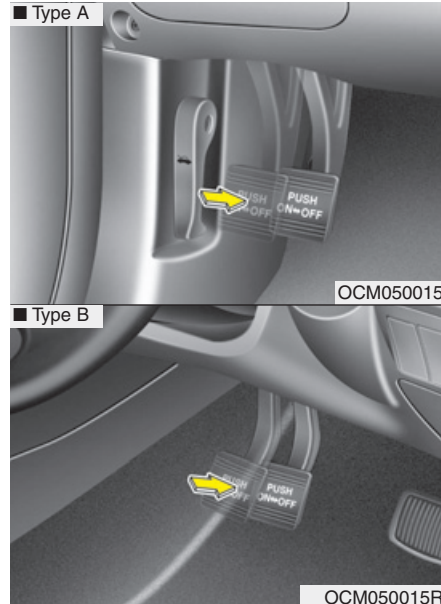

### Foot type

To engage the parking brake, first apply the foot brake and then depress the parking brake pedal down as far as possible.

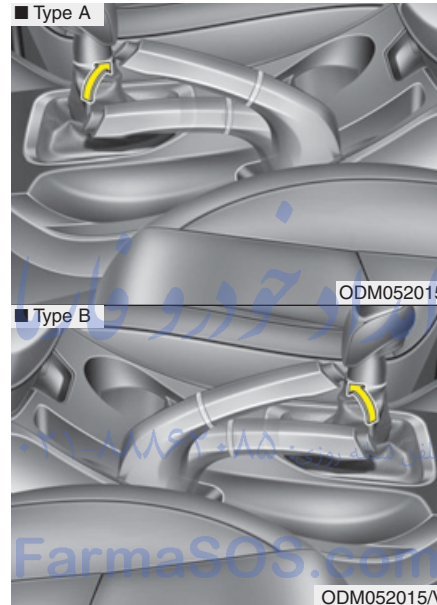

### Hand type

To engage the parking brake, first apply the foot brake and then pull up the parking brake lever as far as possible.

In addition it is recommended that when parking the vehicle on an incline, the shift lever should be in a low gear on manual transaxle vehicles or in the P (Park) position on automatic transaxle vehicles.

### CAUTION

- *Driving with the parking brake applied will cause excessive brake pad and brake rotor wear.*
- *Do not operate the parking brake while the vehicle is moving except in an emergency situation. It could damage the vehicle system and make endanger driving safety.*



### Releasing the parking brake

#### ■ Type A

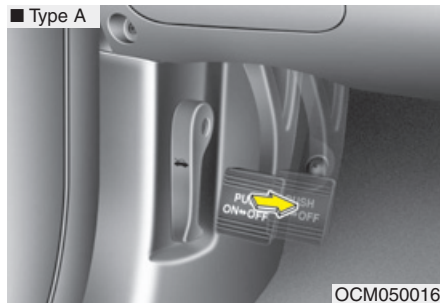

#### ■ Type B

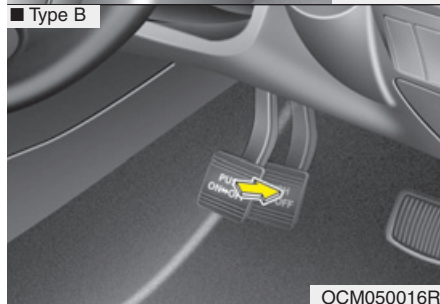

#### Foot type

To release the parking brake, depress the parking brake pedal a second time while applying the foot brake. The pedal will automatically extend to the fully released position.

#### ■ Type A

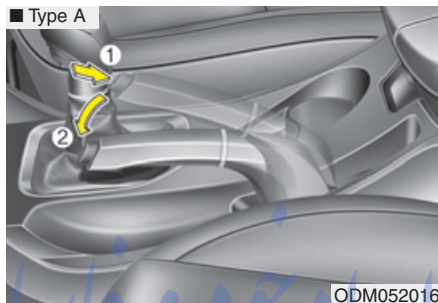

#### ■ Type B

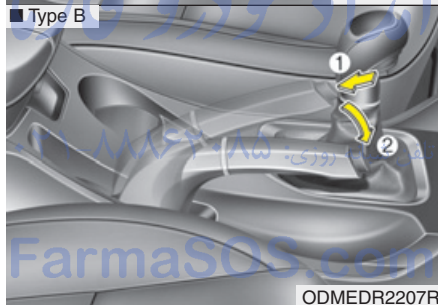

#### Hand type

To release the parking brake, first apply the foot brake and pull up the parking brake lever slightly. Secondly depress the release button (1) and lower the parking brake lever (2) while holding the button.

If the parking brake does not release or does not release all the way, we recommend that the system be checked by an authorized HYUNDAI dealer.

**⚠ WARNING**

- To prevent unintentional movement when stopped and leaving the vehicle, do not use the gearshift lever in place of the parking brake. Set the parking brake AND make sure the gearshift lever is securely positioned in 1st (First) gear or R (Reverse) for manual transaxle equipped vehicles and in P (Park) for automatic transaxle equipped vehicles.
- Never allow anyone who is unfamiliar with the vehicle to touch the parking brake. If the parking brake is released unintentionally, serious injury may occur.
- All vehicles should always have the parking brake fully engaged when parking to avoid inadvertent movement of the vehicle which can injure occupants or pedestrians.



Check the brake warning light by turning the ignition switch ON (do not start the engine). This light will be illuminated when the parking brake is applied with the ignition switch in the START or ON position.

Before driving, be sure the parking brake is fully released and the brake warning light is off.

If the brake warning light remains on after the parking brake is released while engine is running, there may be a malfunction in the brake system. Immediate attention is necessary.

If at all possible, cease driving the vehicle immediately. If that is not possible, use extreme caution while operating the vehicle and only continue to drive the vehicle until you can reach a safe location or repair shop.

## Electric parking brake (EPB)

### Applying the parking brake

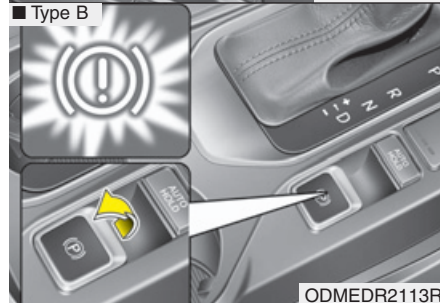
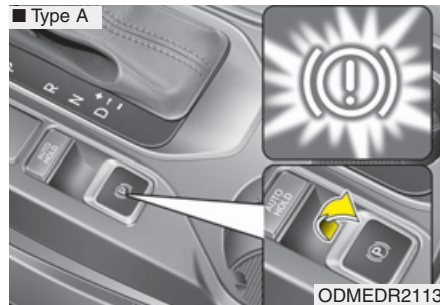

### To apply the EPB (electric parking brake):

1. Depress the brake pedal.
2. Pull up the EPB switch.

Make sure the warning light comes on.

Also, the EPB is applied automatically if the Auto Hold button is on when the engine is turned off. However, if you keep pressing the EPB switch till the engine is turned off, the EPB will not be applied.

امداد خودرو فارما

تلفن شبانه روزی: ۰۲۱-۸۸۸۶۲۰۸۵

FarmaSOS.com

## \* NOTICE

On a steep incline or when pulling a trailer if the vehicle does not stand still, do as follows:

1. Apply the EPB.
2. Pull up the EPB switch for more than 3 seconds.

## ⚠ CAUTION

*Do not operate the parking brake while the vehicle is moving except in an emergency situation. It could damage the vehicle system and endanger driving safety.*

## Releasing the parking brake

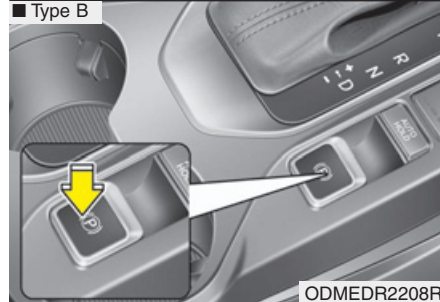
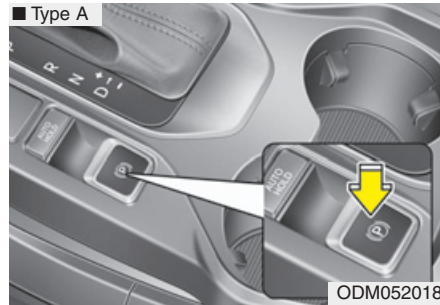

**To release the EPB (electric parking brake), press the EPB switch in the following condition:**

- Have the ignition switch or engine start/stop button in the ON position.

- Depress the brake pedal.  
Make sure the brake warning light goes off.

**To release EPB (electric parking brake) automatically:**

- Shift lever in P (Park)  
With the engine running depress the brake pedal and shift out of P (Park) to R (Rear) or D (Drive).
- Shift lever in N (Neutral)  
With the engine running depress the brake pedal and shift out of N (Neutral) to R (Rear) or D (Drive).
- Manual transaxle vehicle
  1. Start the engine.
  2. Fasten the driver's seat belt.
  3. Close the driver's door, engine hood and tailgate/trunk.
  4. Depress the clutch pedal with the gear engaged.
  5. Depress the accelerator pedal while releasing the clutch pedal.

- Automatic transaxle vehicle
  1. Start the engine.
  2. Fasten the driver's seat belt.
  3. Close the driver's door, engine hood and tailgate/trunk.
  4. Depress the accelerator pedal while the shift lever is in R (Rear), D (Drive) or Sports mode.

Make sure the brake warning light goes off.

### \* NOTICE

- For your safety, you can engage the EPB even though the ignition switch or engine stop/start button is in the OFF position, but you cannot release it.
- For your safety, depress the brake pedal and release the parking brake manually with the EPB switch when you drive downhill or when backing up the vehicle.

### \* NOTICE - Manual transaxle

A vehicle towing a trailer on a hill or on an incline may slightly roll backwards when starting the vehicle. To prevent the situation follow the below instructions.

1. Depress the clutch pedal and select a gear.
- 2 Keep pulling up the EPB switch.
3. Depress the accelerator pedal and slowly release the clutch pedal.
4. If the vehicle starts off with enough driving power release the EPB switch.

Do not follow the above procedure when driving on a flat level ground. The vehicle may suddenly move forward.

### ⚠ CAUTION

- *If the parking brake warning light is still on even though the EPB has been released, we recommend that the system be checked by an authorized HYUNDAI dealer.*
- *Do not drive your vehicle with the EPB applied. It may cause excessive brake pad and brake rotor wear.*

EPB (electric parking brake) may be automatically applied when:

- The EPB is overheated
- Requested by other systems

### \* NOTICE

If the driver turns the engine off by mistake while Auto Hold is operating, EPB will be automatically applied. (Vehicles equipped with Auto Hold)

تلفن شبانه روزی: ۰۲۱-۸۸۸۶۲۰۸۵

FarmaSOS.com

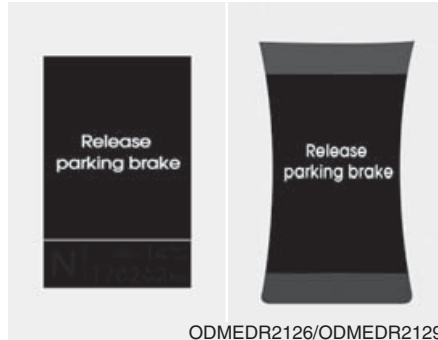
**System warning**

ODMEDR2126/ODMEDR2129

- If you try to drive off depressing the accelerator pedal with the EPB applied, but doesn't release automatically, a warning will sound and a message will appear.
- If the driver's seat belt is not fastened and the engine hood (when the gear is in D [Drive] position or R [Reverse] position) or tailgate/trunk (when the gear is in D [Drive] position or R [Reverse] position) is opened, a warning will sound and a message will appear.
- If there is a problem with the vehicle, a warning may sound and a message may appear.

If the above situation occurs, depress the brake pedal and release EPB by pressing the EPB switch.

**⚠ WARNING**

- To prevent unintentional movement when stopped and leaving the vehicle, do not use the shift lever in place of the parking brake. Set the parking brake and make sure the shift lever is securely positioned in P (Park).
- Never allow anyone who is unfamiliar with the vehicle to touch the parking brake. If the parking brake is released unintentionally, serious injury may occur.
- All vehicles should always have the parking brake fully engaged when parking to avoid inadvertent movement of the car which can injure occupants or pedestrians.

**⚠ CAUTION**

- A click sound may be heard while operating or releasing the EPB, but these conditions are normal and indicate that the EPB is functioning properly.
- When leaving your keys with a parking lot attendant or valet, make sure to inform him/her how to operate the EPB.
- The EPB may malfunction if you drive with the EPB applied.
- When you automatically release EPB by depressing the accelerator pedal, depress it slowly.

### System warning



ODMEDR2127/ODMEDR2130

When the conversion from Auto Hold to EPB is not working properly a warning will sound and a message will appear.

#### CAUTION

***Depress the brake pedal when the above message appears for the Auto Hold and EPB may not activate.***

### System warning

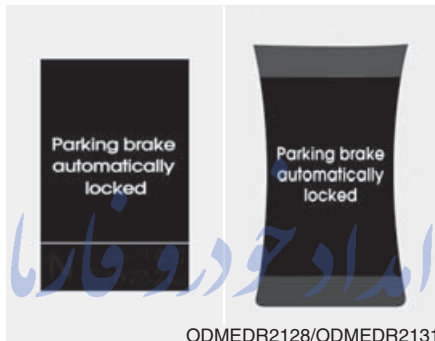

ODMEDR2128/ODMEDR2131

- If the EPB is applied while Auto Hold is activated because of ESC (Electronic Stability Control) signal, a warning will sound and a message will appear.
- If the driver's door is opened and the seatbelt is not fastened while Auto Hold is opened, a warning will sound and a message will appear.

### EPB malfunction indicator (if equipped)

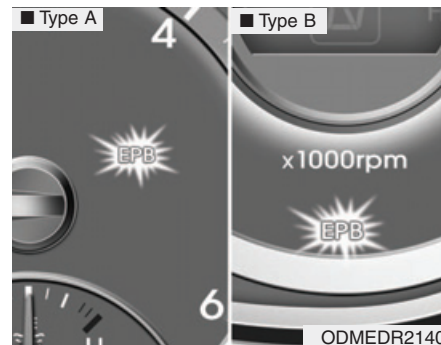

ODMEDR2140

This warning light illuminates if the engine start/stop button is changed to the ON position and goes off in approximately 3 seconds if the system is operation normally.

If the EPB malfunction indicator remains on, comes on while driving, or does not come on when the ignition switch or the engine start/stop button is changed to the ON position, this indicates that the EPB may have malfunctioned.

If this occurs, we recommend that the system be checked by an authorized HYUNDAI dealer.

The EPB malfunction indicator may illuminate when the ESC indicator comes on to indicate that the ESC is not working properly, but it does not indicate a malfunction of the EPB.

 **CAUTION**

- *The EPB warning light may illuminate if the EPB switch operates abnormally. Shut the engine off and turn it on again after a few minutes. The warning light will go off and the EPB switch will operate normally. However, if the EPB warning light is still on, we recommend that the system be checked by an authorized HYUNDAI dealer.*
- *If the parking brake warning light does not illuminate or blinks even though the EPB switch was pulled up, the EPB is not applied.*
- *If the parking brake warning light blinks when the EPB warning light is on, press the switch, then pull it up. Once more press it back to its original position and pull it back up. If the EPB warning does not go off, we recommend that the system be checked by an authorized HYUNDAI dealer.*

## Emergency braking

If there is a problem with the brake pedal while driving, emergency braking is possible by pulling up and holding the EPB switch. Braking is possible only while you are holding the EPB switch.

 **WARNING**

**Do not operate the parking brake while the vehicle is moving except in an emergency situation.**



**\* NOTICE**

During emergency braking by the EPB, the parking brake warning light will illuminate to indicate that the system is operating.

**⚠ CAUTION**

*If you continuously notice a noise or burning smell when the EPB is used for emergency braking, we recommend that the system be checked by an authorized HYUNDAI dealer.*

***When the EPB (electric parking brake) does not release***

If the EPB does not release normally, we recommend that you contact an authorized HYUNDAI dealer by loading the vehicle on a flatbed tow truck and have the system checked.

**AUTO HOLD (if equipped)**

The Auto Hold maintains the vehicle in a standstill even though the brake pedal is not depressed after the driver brings the vehicle to a complete stop by depressing the brake pedal.

امداد خودرو فارما

تلفن شبانه روزی: ۰۲۱-۸۸۸۶۲۰۸۵

FarmaSOS.com

### Set up

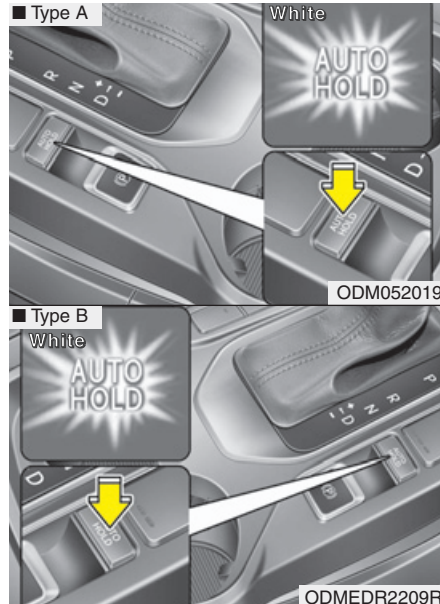

1. With the driver's door, engine hood and tailgate/trunk closed, fasten the driver's seat belt or depress the brake pedal and then press the Auto Hold button. The white AUTO HOLD indicator will come on and the system will be in the standby position.



2. When you stop the vehicle completely by depressing the brake pedal, the AUTO HOLD indicator changes from white to green.  
3. The vehicle will remain stationary even if you release the brake pedal.

4. If EPB is applied, Auto Hold will be released.

### Leaving

If you press the accelerator pedal with the shift lever in R (Reverse), D (Drive) or sports mode, the Auto Hold will be released automatically and the vehicle will start to move. The indicator changes from green to white.

**⚠ WARNING**  
When driving off from Auto Hold by depressing the accelerator pedal, always check the surrounding area near your vehicle.  
Slowly depress the accelerator pedal for a smooth launch.

### Cancel

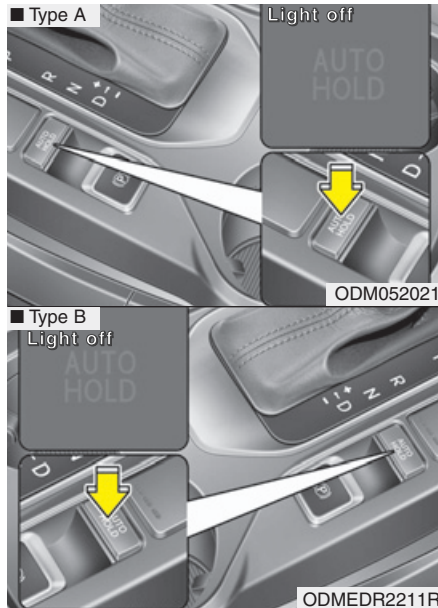

To cancel the Auto Hold operation, press the Auto Hold switch. The AUTO HOLD indicator will go out.

To cancel the Auto Hold operation when the vehicle is at a standstill, press the Auto Hold switch while depressing the brake pedal.

### \* NOTICE

- The Auto Hold does not operate when:
  - The driver's seat belt is unfastened and driver's door is opened
  - The engine hood is opened when the gear is in D [Drive]
  - The tailgate/trunk is opened when the gear is in R [Reverse]
  - The shift lever is in P (Park)
  - The EPB is applied
- For your safety, the Auto Hold automatically switches to EPB in such cases:
  - The driver's seat belt is unfastened and driver's door is opened
  - The engine hood is opened when the gear is in D [Drive]
  - The tailgate/trunk is opened when the gear is in R [Reverse]
  - The vehicle is in a standstill for more than 10 minutes
  - The vehicle is standing on a steep slope
  - The vehicle moved several times

(Continued)

### (Continued)

- In these cases, the brake warning light comes on, the AUTO HOLD indicator changes from green to white, and a warning sounds and a message will appear to inform you that EPB has been automatically engaged. Before driving off again, press foot brake pedal, check the surrounding area near your vehicle and release parking brake manually with the EPB switch.
- If the AUTO HOLD indicator lights up yellow, the Auto Hold is not working properly. We recommend that you contact an authorized HYUNDAI dealer.
  - While operating Auto Hold, you may hear mechanical noise. However, it is normal operating noise.

**⚠ WARNING**

- Press the accelerator pedal slowly when you start the vehicle.
- For your safety, cancel the Auto Hold when you drive downhill or back up the vehicle or park the vehicle.

**⚠ CAUTION**

*If there is a malfunction with the driver's door, engine hood or tailgate/ trunk open detection system, the Auto Hold may not work properly.*

*We recommend that you contact an authorized HYUNDAI dealer.*

**Anti-lock brake system (ABS)****⚠ WARNING**

ABS (or ESC) will not prevent accidents due to improper or dangerous driving maneuvers. Even though vehicle control is improved during emergency braking, always maintain a safe distance between you and objects ahead. Vehicle speeds should always be reduced during extreme road conditions.

The braking distance for vehicle equipped with an anti-lock braking system (or Electronic Stability Control System) may be longer than for those without it in the following road conditions.

During these conditions the vehicle should be driven at reduced speeds:

- Rough, gravel or snow-covered roads.
- With tire chains installed.

(Continued)

(Continued)

- On roads where the road surface is pitted or has different surface height.

The safety features of an ABS (or ESC) equipped vehicle should not be tested by high speed driving or cornering. This could endanger the safety of yourself or others.

The ABS continuously senses the speed of the wheels. If the wheels are going to lock, the ABS system repeatedly modulates the hydraulic brake pressure to the wheels.

When you apply your brakes under conditions which may lock the wheels, you may hear a “tik-tik” sound from the brakes, or feel a corresponding sensation in the brake pedal. This is normal and it means your ABS is active.

In order to obtain the maximum benefit from your ABS in an emergency situation, do not attempt to modulate your brake pressure and do not try to pump your brakes. Press your brake pedal as hard as possible or as hard as the situation warrants and allow the ABS to control the force being delivered to the brakes.

### \* NOTICE

**A click sound may be heard in the engine compartment when the vehicle begins to move after the engine is started. These conditions are normal and indicate that the anti-lock brake system is functioning properly.**

- Even with the anti-lock brake system, your vehicle still requires sufficient stopping distance. Always maintain a safe distance from the vehicle in front of you.
- Always slow down when cornering. The anti-lock brake system cannot prevent accidents resulting from excessive speeds.
- On loose or uneven road surfaces, operation of the anti-lock brake system may result in a longer stopping distance than for vehicles equipped with a conventional brake system.



W-78

### CAUTION

- ***If the ABS warning light is on and stays on, you may have a problem with the ABS. In this case, however, your regular brakes will work normally.***
- ***The ABS warning light will stay on for approximately 3 seconds after the ignition switch is ON. During that time, the ABS will go through self-diagnosis and the light will go off if everything is normal. If the light stays on, you may have a problem with your ABS. We recommend that you contact an authorized HYUNDAI dealer .***

### ⚠ CAUTION

- When you drive on a road having poor traction, such as an icy road, and operate your brakes continuously, the ABS will be active continuously and the ABS warning light may illuminate. Pull your vehicle over to a safe place and stop the engine.
- Restart the engine. If the ABS warning light is off, then your ABS system is normal. Otherwise, you may have a problem with the ABS. We recommend that you contact an authorized HYUNDAI dealer.

### \* NOTICE

When you jump start your vehicle because of a drained battery, the engine may not run as smoothly and the ABS warning light may turn on at the same time. This happens because of the low battery voltage. It does not mean your ABS is malfunctioning.

- Do not pump your brakes!
- Have the battery recharged before driving the vehicle.

تلفن شبانه روزی: ۰۲۱-۸۸۸۶۲۰۸۵

FarmaSOS.com

### Electronic stability control (ESC) (if equipped)

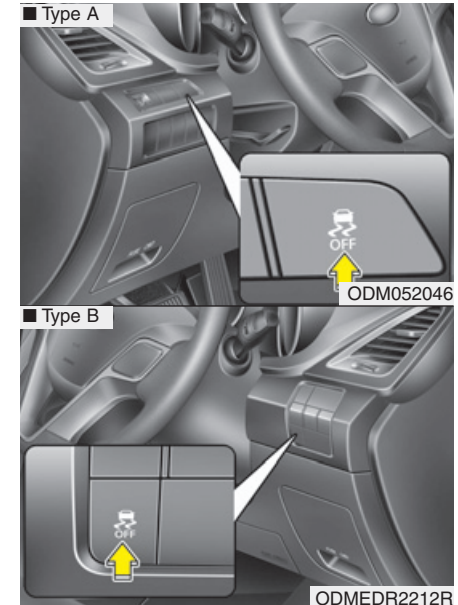

The Electronic Stability Control (ESC) system is designed to stabilize the vehicle during cornering maneuvers.

ESC checks where you are steering and where the vehicle is actually going.

ESC applies the brakes at individual wheels and intervenes with engine management system to stabilize the vehicle.

### **WARNING**

**Never drive too fast for the road conditions or too quickly when cornering. Electronic stability control (ESC) will not prevent accidents. Excessive speed in turns, abrupt maneuvers and hydroplaning on wet surfaces can still result in serious accidents. Only a safe and attentive driver can prevent accidents by avoiding maneuvers that cause the vehicle to lose traction. Even with ESC installed, always follow all the normal precautions for driving - including driving at safe speeds for the conditions.**

The Electronic Stability Control (ESC) system is an electronic system designed to help the driver maintain vehicle control under adverse conditions. It is not a substitute for safe driving practices. Factors including speed, road conditions and driver steering input can all affect whether ESC will be effective in preventing a loss of control. It is still your responsibility to drive and corner at reasonable speeds and to leave a sufficient margin of safety.

When you apply your brakes under conditions which may lock the wheels, you may hear a “tik-tik” sound from the brakes, or feel a corresponding sensation in the brake pedal. This is normal and it means your ESC is active.

### **\* NOTICE**

A click sound may be heard in the engine compartment when the vehicle begins to move after the engine is started. These conditions are normal and indicate that the Electronic Stability Control (ESC) System is functioning properly.

### **ESC operation**

#### **ESC ON condition**



- When the ignition is turned ON, ESC and ESC OFF indicator lights illuminate for approximately 3 seconds, then ESC is turned on.
- Press the ESC OFF button for at least half a second after turning the ignition ON to turn ESC off. (ESC OFF indicator will illuminate). To turn the ESC on, press the ESC OFF button (ESC OFF indicator light will go off).
- When starting the engine, you may hear a slight ticking sound. This is the ESC performing an automatic system self-check and does not indicate a problem.

**When operating**

When the ESC is in operation, ESC indicator light blinks.



- When the Electronic Stability Control is operating properly, you can feel a slight pulsation in the vehicle. This is only the effect of brake control and indicates nothing unusual.
- When moving out of the mud or slippery road, the engine rpm (revolution per minute) may not increase even if you press the accelerator pedal deeply. This is to maintain the stability and traction of the vehicle and does not indicate a problem.

**ESC operation off****ESC OFF state**



This car has 2 kinds of ESC off states.

If the engine stops when ESC is off, ESC remains off. Upon restarting the engine, the ESC will automatically turn on again.

**• ESC off state 1**

To cancel ESC operation, press the ESC OFF button (ESC OFF ) shortly (ESC OFF indicator light (ESC OFF ) illuminates). At this state, the engine control function does not operate. It means the traction control function does not operate. Brake control function only operates.

**• ESC off state 2**

To cancel ESC operation, press the ESC OFF button (ESC OFF ) for more than 3 seconds. ESC OFF indicator light (ESC OFF ) illuminates and ESC OFF warning chime will sound. At this state, the engine control function and brake control function do not operate. It means the car stability control function does not operate any more.



### Indicator light

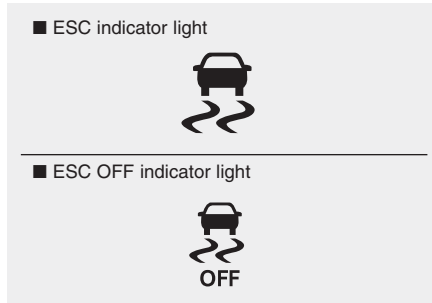

When ignition switch is turned to ON, the indicator light illuminates, then goes off if the ESC system is operating normally.

The ESC indicator light blinks whenever ESC is operating or illuminates when ESC fails to operate.

ESC OFF indicator light comes on when the ESC is turned off with the button.

### CAUTION

*Driving with varying tire or wheel sizes may cause the ESC system to malfunction. When replacing tires, make sure they are the same size as your original tires.*

### WARNING

The Electronic Stability Control system is only a driving aid; use precautions for safe driving by slowing down on curved, snowy, or icy roads. Drive slowly and don't attempt to accelerate whenever the ESC indicator light is blinking, or when the road surface is slippery.

### ESC OFF usage

#### When driving

- ESC should be turned on for daily driving whenever possible.
- To turn ESC off while driving, press the ESC OFF button while driving on a flat road surface.

### WARNING

Never press the ESC OFF button while ESC is operating (ESC indicator light blinks).

If ESC is turned off while ESC is operating, the vehicle may slip out of control.

## \* NOTICE

- When operating the vehicle on a dynamometer, ensure that the ESC is turned off (ESC OFF light illuminated). If the ESC is left on, it may prevent the vehicle speed from increasing, and result in false diagnosis.
- Turning the ESC off does not affect ABS or brake system operation.

## Vehicle stability management (VSM) (if equipped)

This system provides further enhancements to vehicle stability and steering responses when a vehicle is driving on a slippery road or a vehicle detected changes in coefficient of friction between right wheels and left wheels when braking.

### VSM operation

When the VSM is operating:

- ESC (Electronic Stability Control) (  ) light will blink.
- The steering wheel may be controlled.

When the vehicle stability management is operating properly, you can feel a slight pulsation in the vehicle. This is only the effect of brake control and indicates nothing unusual.

The VSM does not operate when:

- Driving on bank road such as gradient or incline
- Driving rearward
- ESC OFF indicator light (  ) remains on the instrument cluster
- EPS (Electronic Power Steering) indicator light remains on the instrument cluster

### VSM operation off

If you press the ESC OFF button to turn off the ESC, the VSM will also cancel and the ESC OFF indicator light (  ) illuminates.

To turn on the VSM, press the button again. The ESC OFF indicator light goes out.

### Malfunction indicator

The VSM can be deactivated even if you don't cancel the VSM operation by pressing the ESC OFF button. It indicates that a malfunction has been detected somewhere in the EPS (Electronic Power Steering) system or VSM system. If the ESC indicator light (  ) or EPS warning light remains on, we recommend that you contact an authorized HYUNDAI dealer.

### \* NOTICE

- The VSM is designed to function above approximately 15 km/h (9 mph) on curves.
- The VSM is designed to function above approximately 30 km/h (18 mph) when a vehicle is braking on a split-mu road. The split-mu road is made of surfaces which have different friction forces.

### WARNING

- **The Vehicle Stability Management system is not a substitute for safe driving practices but a supplementary function only. It is the responsibility of the driver to always check the speed and the distance to the vehicle ahead. Always hold the steering wheel firmly while driving.**
- **Your vehicle is designed to activate according to the driver's intention, even with the VSM installed. Always follow all the normal precautions for driving at safe speeds for the conditions – including driving in inclement weather and on a slippery road.**
- **Driving with varying tire or wheel sizes may cause the VSM system to malfunction. When replacing tires, make sure they are the same size as your original tires.**

### Trailer stability assist (TSA) (if equipped)

Trailer stability assist is operated as vehicle stability control system. Trailer stability assist system has an effort to stabilize the vehicle and trailer when the trailer sways or oscillates. There are various reasons making vehicle sway and oscillate. Almost case it happens at high speed however, if the trailer is affected by crosswinds, buffeting, and improper overloading, it may be a risk of swaying.

Factors of swaying such as:

- High speed
- Strong crosswinds
- Improper overloading
- Sudden controlling of steering wheel
- Uneven road

Trailer stability assist system continuously analyzes the vehicle and trailer instability. When the Trailer stability assist system detects some sway, the brakes are applied automatically to stabilize the vehicle on the front wheel. However, if it is not enough to stabilize, the brakes are applied on all wheels automatically and engine power is properly reduced. When the vehicle is stable from swaying, trailer stability assist system does not operate.

### **Hill-start assist control (HAC) (if equipped)**

A vehicle has the tendency to slip back on a steep hill when it starts to go after stopping. The Hill-start Assist Control (HAC) prevents the vehicle from slipping back by operating the brakes automatically for about 2 seconds. The brakes are released when the accelerator pedal is depressed or after about 2 seconds.

#### **⚠ WARNING**

**The HAC is activated only for about 2 seconds, so when the vehicle is starting off always depress the accelerator pedal.**

### **\* NOTICE**

- The HAC does not operate when the transaxle shift lever is in the P (Park) or N (Neutral) position.
- The HAC activates even though the ESC is off but it does not activate when the ESC has malfunctioned.

### **Emergency Stop Signal (ESS) (if equipped)**

The Emergency Stop Signal system alerts the driver behind by blinking the stop light when the vehicle is braked rapidly and severely.

The system is activated when:

- The vehicle suddenly stops (vehicle speed is over 55km/h and the vehicle deceleration at greater than 7 m/s<sup>2</sup>)
- The ABS is activating

When the vehicle speed is under 40 km/h and the ABS deactivates or the sudden stop situation is over, the stop light blinking will stop. Instead, the hazard warning flasher will turn on automatically.

The hazard warning flasher will turn off when vehicle speed is over 10km/h after the vehicle has stopped. Also, it will turn off when the vehicle is driven at low speed for some time. You can turn it off manually by pushing the hazard warning flasher switch.

**⚠ CAUTION**

*The Emergency Stop Signal (ESS) system will not work if the hazard warning flasher is already on.*

**Downhill brake control (DBC)  
(if equipped)**

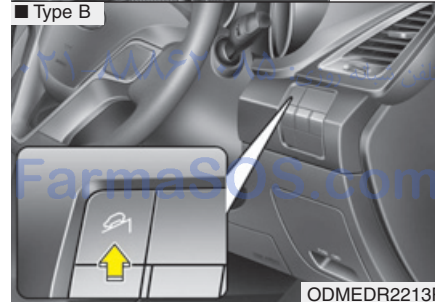
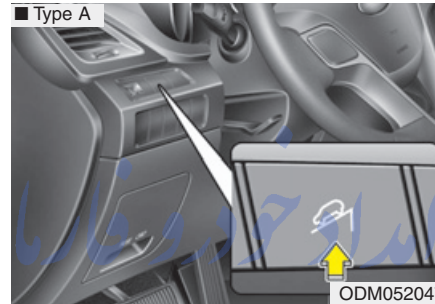

The Downhill Brake Control (DBC) supports the driver come down a steep hill without the driver depressing the brake pedal. It slows down the vehicle under 10 km/h (6.3 mph) and lets the driver concentrate on steering the vehicle.

DBC defaults to the OFF position whenever the ignition is turned on.

The DBC can be turned on or off by pushing the button.

※ The actual feature in the vehicle may differ from the illustration.

Mode	Indicator light	Description
<b>Standby</b>	Green light illuminated	Press the DBC button when the vehicle speed is under 40 km/h (25 mph). The DBC system will turn ON and enter the standby mode. The system maintains the standby mode when vehicle speed is under 60km/h.
<b>Activated</b>	Green light blink	In the standby mode, DBC will activate automatically under the following conditions: <ul style="list-style-type: none"> <li>• The incline is over a certain degree.</li> <li>• The brake pedal or accelerator pedal is not depressed.</li> </ul>
<b>OFF</b>	Green light OFF	The DBC will turn OFF under the following conditions: <ul style="list-style-type: none"> <li>• The DBC button is pressed again.</li> <li>• The vehicle speed is over 60 km/h (38 mph).</li> </ul>
<b>Temporarily deactivated</b>	Green light illuminated	In the activated mode, the DBC will temporarily deactivate under the following conditions: <ul style="list-style-type: none"> <li>• The hill is not steep enough.</li> <li>• The brake pedal or accelerator pedal is depressed.</li> </ul> If the above conditions are gone, the DBC will automatically activate again.

### WARNING

If the DBC yellow indicator light illuminates, the system has overheated or there is an operational problem. The DBC will not activate. If the DBC yellow indicator light illuminates even though the DBC system has been cooled, we recommend that the system be checked by an authorized HYUNDAI dealer.

### \* NOTICE

- The DBC does not turn ON in the P (Park) position.
- The DBC may not activate if the ESC (or BAS) is activated.
- Noise or vibration may occur from the brakes when the DBC is activated.
- The rear stop light comes on when the DBC is activated.
- On a very steep hill even though the brake pedal or accelerator pedal is depressed the DBC may not deactivate.
- Always turn OFF the DBC on normal roads. The DBC might activate from the standby mode during abrupt cornering or driving over speed bumps.
- DBC may activate and cause the engine to stop in vehicles with manual transaxle if you drive in 3rd gear (or above) with DBC on. Do not turn on DBC when driving in 3rd gear (or above).

## Good braking practices

### **⚠ WARNING**

- **Whenever you leave or park your vehicle, always set the parking brake as far as possible and fully engage the vehicle's transaxle into the P (Park) position. If the parking brake is not fully engaged, the vehicle may move inadvertently and injure yourself and others.**
- **All vehicles should always have the parking brake fully engaged when parking to avoid inadvertent movement of the vehicle which can injure occupants or pedestrians.**

- Check to be sure the parking brake is not engaged and that the parking brake indicator light is out before driving away.
- Driving through water may get the brakes wet. They can also get wet when the vehicle is washed. Wet brakes can be dangerous! Your vehicle will not stop as quickly if the brakes are wet. Wet brakes may cause the vehicle to pull to one side.  
To dry the brakes, apply the brakes lightly until the braking action returns to normal, taking care to keep the vehicle under control at all times. If the braking action does not return to normal, stop as soon as it is safe to do so and we recommend that you call an authorized HYUNDAI dealer for assistance.
- Do not coast down hills with the vehicle out of gear. This is extremely hazardous. Keep the vehicle in gear at all times, use the brakes to slow down, then shift to a lower gear so that engine braking will help you maintain a safe speed.
- Do not "ride" the brake pedal. Resting your foot on the brake pedal while driving can be dangerous because it can result in the brakes overheating and losing their effectiveness. It also increases the wear of the brake components.
- If a tire goes flat while you are driving, apply the brakes gently and keep the vehicle pointed straight ahead while you slow down. When you are moving slowly enough for it to be safe to do so, pull off the road and stop in a safe place.
- If your vehicle is equipped with an automatic transaxle, do not let your vehicle creep forward. To avoid creeping forward, keep your foot firmly on the brake pedal when the vehicle is stopped.

- Be cautious when parking on a hill. Firmly engage the parking brake and place the shift lever in P (automatic transaxle) or in first or reverse gear (manual transaxle). If your vehicle is facing downhill, turn the front wheels into the curb to help keep the vehicle from rolling. If your vehicle is facing uphill, turn the front wheels away from the curb to help keep the vehicle from rolling. If there is no curb or if it is required by other conditions to keep the vehicle from rolling, block the wheels.
- Under some conditions your parking brake can freeze in the engaged position. This is most likely to happen when there is an accumulation of snow or ice around or near the rear brakes or if the brakes are wet. If there is a risk that the parking brake may freeze, apply it only temporarily while you put the shift lever in P (automatic transaxle) or in first or reverse gear (manual transaxle) and block the rear wheels so the vehicle cannot roll. Then release the parking brake.
- Do not hold the vehicle on the upgrade with the accelerator pedal. This can cause the transaxle to overheat. Always use the brake pedal or parking brake.

امداد خودرو فارما

تلفن شبانه روزی: ۰۲۱-۸۸۸۶۲۰۸۵

FarmaSOS.com



## CRUISE CONTROL SYSTEM (IF EQUIPPED)

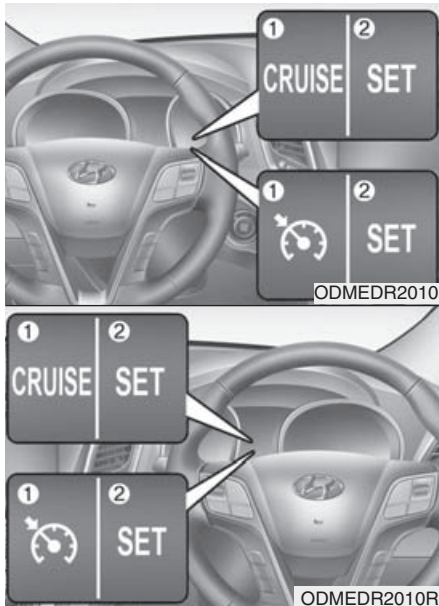

1. Cruise indicator
2. Cruise set indicator

The cruise control system allows you to program the vehicle to maintain a constant speed without depressing the accelerator pedal.

This system is designed to function above approximately 40 km/h (25 mph).

### **⚠ WARNING**

- If the cruise control is left on, (CRUISE indicator light in the instrument cluster is illuminated), the cruise control can be switched on accidentally. Keep the cruise control system off (CRUISE indicator light OFF) when the cruise control is not in use, to avoid inadvertently setting a speed.
- Use the cruise control system only when driving on open highways in good weather.
- Do not use the cruise control when it may not be safe to keep the vehicle at a constant speed, for instance, driving in heavy or varying traffic, or on slippery (rainy, icy or snow-covered) or winding roads or over 6% up-hill or down-hill roads.

(Continued)

### (Continued)

- Pay particular attention to the driving conditions whenever using the cruise control system.
- Be careful when driving downhill using the cruise control system, which may increase the vehicle speed.

### **⚠ CAUTION**

*During cruise-speed driving with a manual transaxle vehicle, do not shift into neutral without depressing the clutch pedal, since the engine will be over-revved. If this happens, depress the clutch pedal or release the CRUISE switch.*

## \* NOTICE

- During normal cruise control operation, when the SET switch is activated or reactivated after applying the brakes, the cruise control will energize after approximately 3 seconds. This delay is normal.
- To activate cruise control, depress the brake pedal at least once after turning the ignition switch to the ON position or starting the engine. This is to check if the brake switch which is important part to cancel cruise control is in normal condition.

## Cruise control switch



-  / CRUISE : Turns cruise control system on or off. تلفن: ۰۲۱-۸۸۶۰۰۰۰
- CANCEL: Cancels cruise control operation.
- RES+: Resumes or increases cruise control speed.
- SET-: Sets or decreases cruise control speed.

## To set cruise control speed:

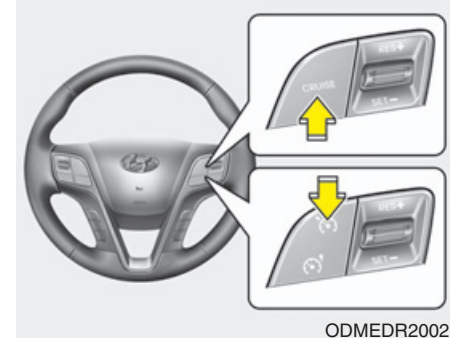

1. Press the /CRUISE button on the steering wheel, to turn the system on. The CRUISE indicator light will illuminate.
2. Accelerate to the desired speed, which must be more than 40 km/h (25 mph).

## \* NOTICE - Manual transaxle

For manual transaxle vehicles, you should depress the brake pedal at least once to set the cruise control after starting the engine.

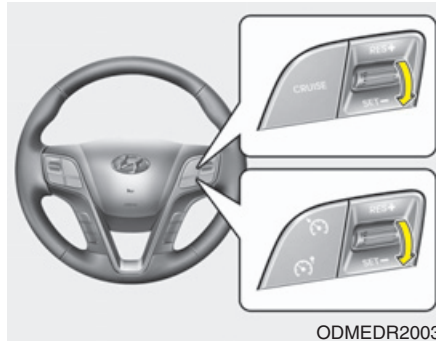

ODMEDR2003

3. Move the lever down (to SET-), and release it at the desired speed. The SET indicator light will illuminate. Release the accelerator pedal at the same time. The desired speed will automatically be maintained.

*On a steep grade, the vehicle may slow down or speed up slightly while going uphill or downhill.*

**To increase cruise control set speed:**

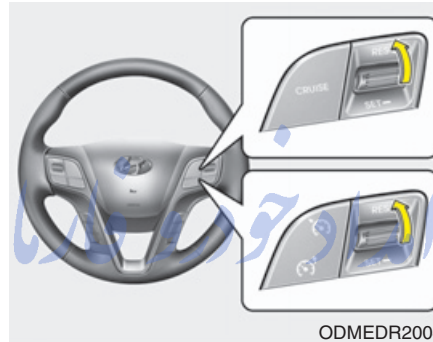

ODMEDR2004

Follow either of these procedures:

- Move the lever up (to RES+) and hold it. Your vehicle will accelerate. Release the lever at the speed you want.
- Move the lever up (to RES+) and release it immediately. The cruising speed will increase by 2.0 km/h or 1 mph each time you move the lever up (to RES+) in this manner.

**To decrease the cruising speed:**

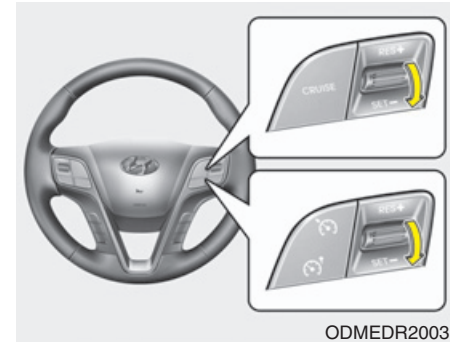

ODMEDR2003

Follow either of these procedures:

- Move the lever down (to SET-) and hold it. Your vehicle will gradually slow down. Release the lever at the speed you want to maintain.
- Move the lever down (to SET-) and release it immediately. The cruising speed will decrease by 2.0 km/h or 1 mph each time you move the lever down (to SET-) in this manner.

### To temporarily accelerate with the cruise control on:

If you want to speed up temporarily when the cruise control is on, depress the accelerator pedal. Increased speed will not interfere with cruise control operation or change the set speed.

To return to the set speed, take your foot off the accelerator pedal.

### To cancel cruise control, do one of the following:

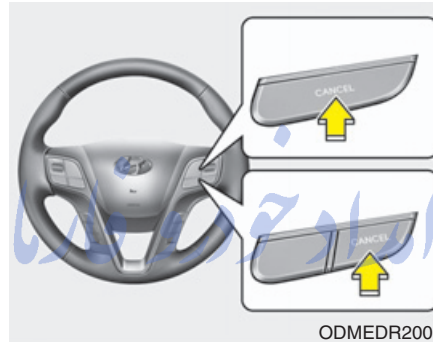

- Depress the brake pedal, تلفن شبانه
- Depress the clutch pedal with a manual transaxle.
- Shift into N (Neutral) with an automatic transaxle.
- Press the CANCEL switch located on the steering wheel.
- Decrease the vehicle speed lower than the memory speed by 20 km/h (12 mph).
- Decrease the vehicle speed to less than approximately 40 km/h (25 mph).

*Each of these actions will cancel cruise control operation (the SET indicator light in the instrument cluster will go off), but it will not turn the system off. If you wish to resume cruise control operation, move up the lever (to RES+) located on your steering wheel. You will return to your previously preset speed.*

**To resume cruising speed at more than approximately 40 km/h (25 mph):**

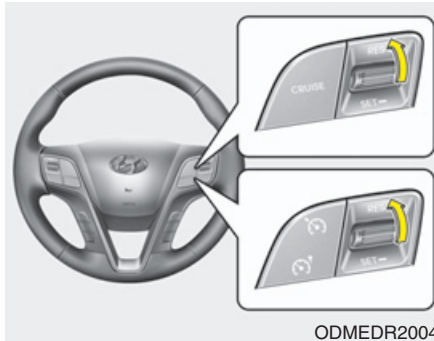

If any method other than the /CRUISE button was used to cancel cruising speed and the system is still activated, the most recent set speed will automatically resume when you move the lever up (to RES+).

It will not resume, however, if the vehicle speed has dropped below approximately 40 km/h (25 mph).

**\* NOTICE**

Always check the road conditions when you move the lever up (to RES+) to resume the speed.

امداد خودرو فارما

تلفن شبانه روزی: ۰۲۱-۸۸۸۶۲۰۸۵

FarmaSOS.com

**To turn cruise control off, do one of the following:**

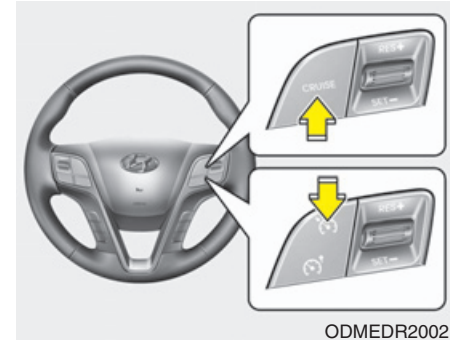

- Press the /CRUISE button. (the CRUISE indicator light in the instrument cluster will go off)
- Turn the ignition off.

*Both of these actions cancel cruise control operation. If you want to resume cruise control operation, repeat the steps provided in "To set cruise control speed" on the previous page.*

## SPEED LIMIT CONTROL SYSTEM (IF EQUIPPED)

You can set the speed limit when you do not want to drive over a specific speed.

If you drive over the preset speed limit, the warning system operates (set speed limit will blink and chime will sound) until the vehicle speed returns within the speed limit.

### \* NOTICE

While speed limit control is in operation, the cruise control system cannot be activated.

### Speed limit control switch

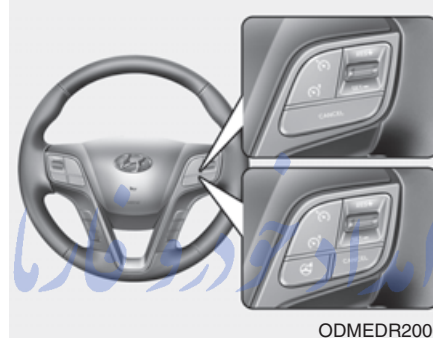

: Turns speed limit control system on or off.

CANCEL: Cancels set speed limit.

RES+: Resumes or increases speed limit control speed.

SET-: Sets or decreases speed limit control speed.

### To set speed limit :



1. Press the speed limit  button on the steering wheel, to turn the system on.

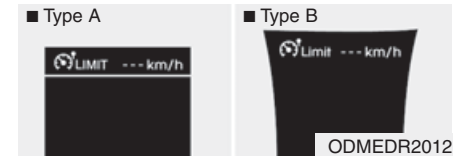

The speed limit indicator light will illuminate.

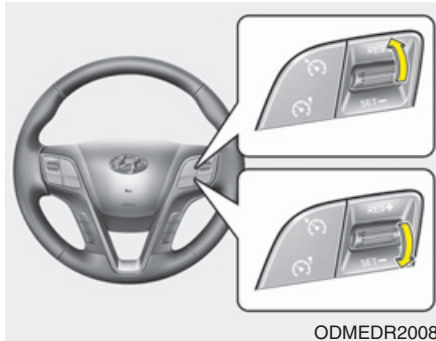

2. Move the lever down (to SET-).
3. Move the lever up (to RES+) or down (to SET-), and release it at the desired speed. Move the lever up (to RES+) or down (to SET-) and hold it. The speed will increase or decrease by 5 km/h (3 mph).

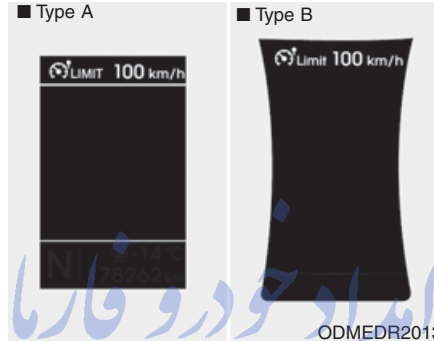

The set speed limit will be displayed.

تلفن شبانه روزی: ۰۲۱-۸۸۸۶۲۰۸۵

FarmaSOS.com



To drive over the preset speed limit you must depress hard on the accelerator pedal (more than approximately 80%) until the kick down mechanism works with a clicking noise. Then the set speed limit will blink and chime will sound until you return the vehicle speed within the speed limit.

### \* NOTICE

- Depressing the accelerator pedal less than approximately 50%, the vehicle will not speed over the pre-set speed limit but maintain the vehicle speed within the speed limit.
- A clicking noise heard from the kick down mechanism by depressing the accelerator pedal fully is a normal condition.

To turn off the speed limit control, do one of the following:

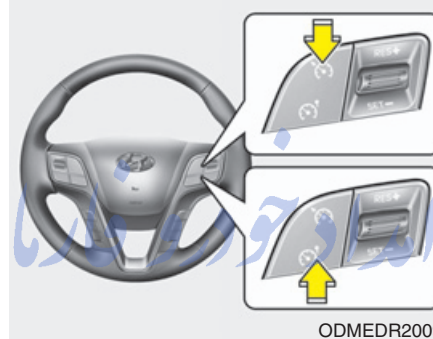

- Press the speed limit button once again.
- Press the cruise switch (If you press cruise switch, the cruise system will turn on)

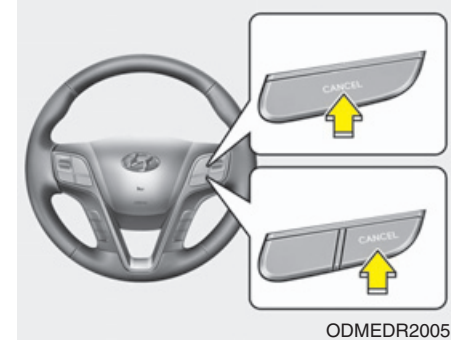

If you press the CANCEL switch once, the set speed limit will cancel, but it will not turn the system off. If you wish to reset the speed limit, move the lever up (to RES+) or down (to SET-) to the desired speed.



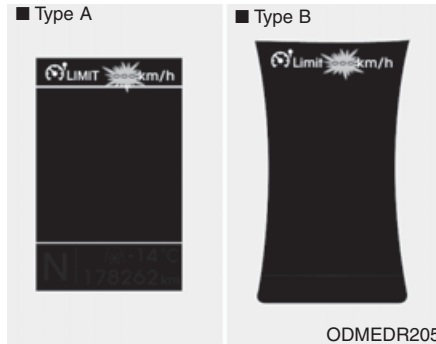

**⚠ CAUTION**

*The "---" indicator will blink if there is a problem with speed limit control system.*

*If this occurs, we recommend that the system be checked by an authorized HYUNDAI dealer.*

امداد خودرو فارما

تلفن شبانه روزی: ۰۲۱-۸۸۸۶۲۰۸۵

FarmaSOS.com

## LANE DEPARTURE WARNING SYSTEM (LDWS) (IF EQUIPPED)

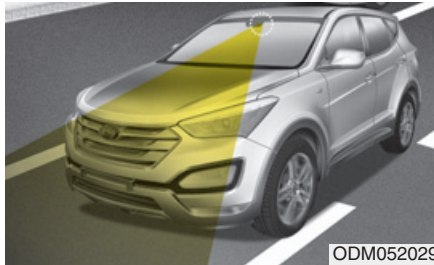

ODM052029



ODM052048

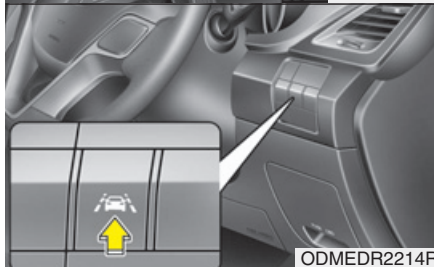

ODMEDR2214R

This system detects the lane with the sensor at the front windshield and warns you when your vehicle leaves the lane.

### **⚠ WARNING**

- The LDWS does **not** make the vehicle change lanes. It is the driver's responsibility to always check the road conditions.
- Do not turn the steering wheel suddenly, when the LDWS warns you that your vehicle is leaving the lane.
- If the sensor can not detect the lane or if the vehicle speed does not exceed 60 km/h (35 mph), the LDWS won't warn you even though vehicle leaves the lane.
- If your vehicle has window tint or other types of coating and accessory on the front windshield, the LDWS may not work properly.

(Continued)

### (Continued)

- Do not let water or any kind of liquid come in contact with the LDWS sensor.
- Do not remove the LDWS parts and do not affect the sensor by a strong impact.
- Do not put objects that reflect light on the dash board.
- Always check the road conditions because you may not hear the warning chime because of audio, and external conditions.



To operate the LDWS, press the button with the engine start/stop button in the ON position. The indicator illuminates on the cluster. To cancel the LDWS, press the button again.

The color of symbol will change depend on the condition of LDWS.

- White color : It means the sensor does not detect the lane line.
- Green color : It means the sensor detects the lane line.



If your vehicle leaves the lane when the LDWS is operating and vehicle speed exceeds 60 km/h (35 mph), the warning operates as follows:

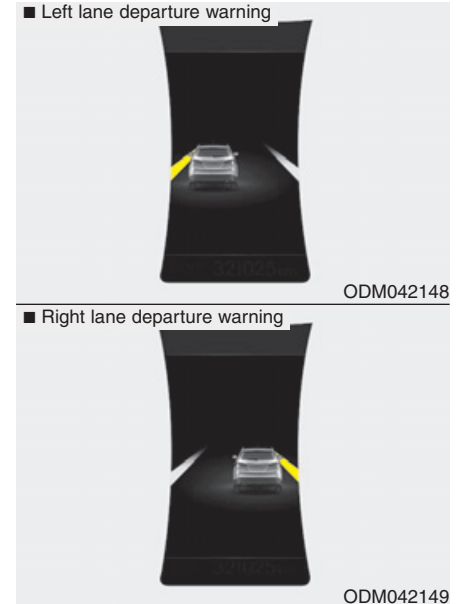

### 1. Visual warning

If you leave the lane, the lane you leave on the LCD display blinks yellow with 0.8 seconds of interval.

## 2. Auditory warning

If you leave the lane, the warning sound operates with 0.8 seconds of interval.

### Warning indicator



If the LDWS FAIL warning indicator (yellow) comes on, the LDWS is not working properly. If this occurs, we recommend that the system be checked by an authorized HYUNDAI dealer.

### The LDWS does not operate when:



- The driver turns on the turn signal to change lane.

But, when the hazard warning flasher is operating, the LDWS operates normally.

- Operating the wiper switch with HI mode due to heavy rain.
- Driving on the lane line.

### \* NOTICE

To change lane, operate the turn signal switch then change the lane.

**The LDWS may not warn you even if the vehicle leaves the lane, or may warn you even if the vehicle does not leave the lane when;**

- The lane can't be visible due to snow, rain, stain, a puddle or many other things.
- The brightness of the outside changes suddenly such as tunnel enter/exit.
- Not turning on the headlight even at night or in the tunnel, or light is weak.
- Difficult to distinguish the color of the lane from the road.
- Driving on a steep grade or a curve.
- Such as street light, sunlight or oncoming vehicle light reflects from the water on the road.
- The lens or windshield is stained with foreign matter.
- The sensor cannot detect the lane because of fog, heavy rain or heavy snow.
- The surrounding of the inside rear view mirror temperature is high due to a direct ray of light.
- The lane is very wide or narrow.
- The lane line is damaged or indistinct.
- The shadow is on the lane line by a median strip.
- There is a mark similar to a lane line.
- There is a boundary structure.
- The distance from vehicle ahead is very short or the vehicle ahead drives hiding the lane line.
- The vehicle shakes heavily.
- The lane number increases or decreases or the lane lines are crossing complicatedly.
- Putting something on the dashboard.
- Driving with the sun in front of you.
- Driving in areas under construction.
- The lane line is more than two in either side (Left/Right).

## ACTIVE ECO SYSTEM

### Active ECO operation

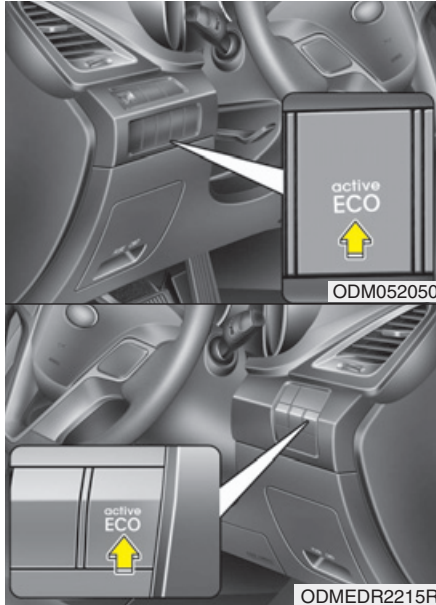

Active ECO helps improve fuel efficiency by controlling certain engine and transaxle system operating parameters. Fuel efficiency depends on the driver's driving habit and road condition.

- When the Active ECO button is pressed the ECO indicator (green) will illuminate to show that the Active ECO is operating.
- When the Active ECO is activated, it will remain on until the Active ECO button is pressed again. Active ECO does not turn off when the engine is restarted. To turn off Active ECO, press the Active ECO button again.
- If Active ECO is turned off, the system will return to normal mode.

### When Active ECO is activated :

- The engine noise may get louder.
- The vehicle speed may slightly be reduced.
- The air conditioner performance may be affected.

### Limitation of Active ECO operation:

If the following conditions occur while Active ECO is operating, the system operation is limited even though there is no change in the ECO indicator.

- When the coolant temperature is low:  
The system will be limited until engine performance becomes normal.
- When driving up a hill:  
The system will be limited to gain power when driving uphill because the engine torque is restricted.
- When using sports mode:  
The system will be limited according to the shift location.
- When the accelerator pedal is deeply depressed for a few seconds:  
The system will be limited, judging that the driver wants to speed up. (Gasoline engine only)

### ECONOMICAL OPERATION

Your vehicle's fuel economy depends mainly on your style of driving, where you drive and when you drive.

Each of these factors affects how many kilometers (miles) you can get from a liter (gallon) of fuel. To operate your vehicle as economically as possible, use the following driving suggestions to help save money in both fuel and repairs:

- Drive smoothly. Accelerate at a moderate rate. Do not make "jack-rabbit" starts or full-throttle shifts and maintain a steady cruising speed. Do not race between stoplights. Try to adjust your speed to the traffic so you do not have to change speeds unnecessarily. Avoid heavy traffic whenever possible. Always maintain a safe distance from other vehicles so you can avoid unnecessary braking. This also reduces brake wear.
- Drive at a moderate speed. The faster you drive, the more fuel your vehicle uses. Driving at a moderate speed, especially on the highway, is one of the most effective ways to reduce fuel consumption.
- Do not "ride" the brake or clutch pedal. This can increase fuel consumption and also increase wear on these components. In addition, driving with your foot resting on the brake pedal may cause the brakes to overheat, which reduces their effectiveness and may lead to more serious consequences.
- Take care of your tires. Keep them inflated to the recommended pressure. Incorrect inflation, either too much or too little, results in unnecessary tire wear. Check the tire pressures at least once a month.
- Be sure that the wheels are aligned correctly. Improper alignment can result from hitting curbs or driving too fast over irregular surfaces. Poor alignment causes faster tire wear and may also result in other problems as well as greater fuel consumption.
- Keep your vehicle in good condition. For better fuel economy and reduced maintenance costs, maintain your vehicle in accordance with the maintenance schedule in section 7. If you drive your vehicle in severe conditions, more frequent maintenance is required (see section 7 for details).
- Keep your vehicle clean. For maximum service, your vehicle should be kept clean and free of corrosive materials. It is especially important that mud, dirt, ice, etc. not be allowed to accumulate on the underside of the vehicle. This extra weight can result in increased fuel consumption and also contribute to corrosion.
- Travel lightly. Do not carry unnecessary weight in your vehicle. Weight reduces fuel economy.
- Do not let the engine idle longer than necessary. If you are waiting (and not in traffic), turn off your engine and restart only when you're ready to go.

- Remember, your vehicle does not require extended warm-up. After the engine has started, allow the engine to run for 10 to 20 seconds prior to placing the vehicle in gear. In very cold weather, however, give your engine a slightly longer warm-up period.
- Do not "lug" or "over-rev" the engine. Lugging is driving too slowly in too high a gear resulting engine bucking. If this happens, shift to a lower gear. Over-revving is racing the engine beyond its safe limit. This can be avoided by shifting at the recommended speeds.
- Use your air conditioning sparingly. The air conditioning system is operated by engine power so your fuel economy is reduced when you use it.
- Open windows at high speeds can reduce fuel economy.
- Fuel economy is less in crosswinds and headwinds. To help offset some of this loss, slow down when driving in these conditions.

Keeping a vehicle in good operating condition is important both for economy and safety. Therefore, we recommend that the system be serviced by an authorized HYUNDAI dealer.

**⚠ WARNING - Engine off during motion**

**Never turn the engine off to coast down hills or anytime the vehicle is in motion. The power steering and power brakes will not function properly without the engine running. Instead, keep the engine on and downshift to an appropriate gear for engine braking effect. In addition, turning off the ignition while driving could engage the steering wheel lock (if equipped) resulting in loss of vehicle steering which could cause serious injury or death.**



## SPECIAL DRIVING CONDITIONS

### Hazardous driving conditions

When hazardous driving conditions are encountered such as water, snow, ice, mud, sand, or similar hazards, follow these suggestions:

- Drive cautiously and allow extra distance for braking.
- Avoid sudden braking or steering.
- When braking with non-ABS brakes pump the brake pedal with a light up-and-down motion until the vehicle is stopped.

#### **⚠ WARNING - ABS**

**Do not pump the brake pedal on a vehicle equipped with ABS.**

- If stalled in snow, mud, or sand, use second gear. Accelerate slowly to avoid spinning the drive wheels.
- Use sand, rock salt, tire chains, or other non-slip material under the drive wheels to provide traction when stalled in ice, snow, or mud.

#### **⚠ WARNING - Downshifting**

**Downshifting with an automatic transaxle, while driving on slippery surfaces can cause an accident. The sudden change in tire speed could cause the tires to skid. Be careful when downshifting on slippery surfaces.**

تلفن شبانه روزی: ۰۲۱-۸۸۸۶۲۰۸۵

FarmaSOS.com

### Reducing the risk of a rollover

This multi-purpose passenger vehicle is defined as a Sports Utility Vehicle (SUV).

SUV's have higher ground clearance and a narrower track to make them capable of performing in a wide variety of road applications. Specific design characteristics give them a higher center of gravity than ordinary vehicles. An advantage of the higher ground clearance is a better view of the road, which allows you to anticipate problems. They are not designed for cornering at the same speeds as conventional passenger vehicles. Due to this risk, driver and passengers are strongly recommended to buckle their seat belts. In a rollover crash, an unbelted person is more likely to die than a person wearing a seat belt. There are steps that a driver can make to reduce the risk of a rollover. If at all possible, avoid sharp turns or abrupt maneuvers, do not load your roof rack with heavy cargo, and never modify your vehicle in any way.

**⚠ WARNING - Rollover**

As with other Sports Utility Vehicle (SUV), failure to operate this vehicle correctly may result in loss of control, an accident or vehicle rollover.

- Utility vehicles have a significantly higher rollover rate than other types of vehicles.
- Specific design characteristics (higher ground clearance, narrower track, etc.) give this vehicle a higher center of gravity than ordinary vehicles.
- A SUV is not designed for cornering at the same speeds as conventional vehicles.
- Avoid sharp turns or abrupt maneuvers.
- In a rollover crash, an unbelted person is significantly more likely to die than a person wearing a seat belt. Make sure everyone in the vehicle is properly buckled up.

**⚠ WARNING**

Your vehicle is equipped with tires designed to provide safe ride and handling capability. Do not use a size and type of tire and wheel that is different from the one that is originally installed on your vehicle. It can affect the safety and performance of your vehicle, which could lead to steering failure or rollover and serious injury. When replacing the tires, be sure to equip all four tires with the tire and wheel of the same size, type, tread, brand and load-carrying capacity. If you nevertheless decide to equip your vehicle with any tire/wheel combination not recommended by HYUNDAI for off road driving, you should not use these tires for highway driving.

**Rocking the vehicle**

If it is necessary to rock the vehicle to free it from snow, sand, or mud, first turn the steering wheel right and left to clear the area around your front wheels. Then, shift back and forth between 1 (First) and R (Reverse) in vehicles equipped with a manual transaxle or R (Reverse) and any forward gear in vehicles equipped with an automatic transaxle. Do not race the engine, and spin the wheels as little as possible. If you are still stuck after a few tries, have the vehicle pulled out by a tow vehicle to avoid engine overheating and possible damage to the transaxle.

**⚠ CAUTION**

*Prolonged rocking may cause engine over-heating, transaxle damage or failure, and tire damage.*

**⚠ WARNING - Spinning tires**

Do not spin the wheels, especially at speeds more than 56 km/h (35 mph). Spinning the wheels at high speeds when the vehicle is stationary could cause a tire to overheat which could result in tire damage that may injure bystanders.

**\* NOTICE**

The ESC system should be turned OFF prior to rocking the vehicle.

**⚠ WARNING**

If your vehicle becomes stuck in snow, mud, sand, etc., then you may attempt to rock the vehicle free by moving it forward and backward. Do not attempt this procedure if people or objects are anywhere near the vehicle. During the rocking operation the vehicle may suddenly move forward or backward as it becomes unstuck, causing injury or damage to nearby people or objects.

تلفن سبانه زوری: ۰۸۵-۲۰۸۸۶۲-۲۱

FarmaSOS.com

**Smooth cornering**



Avoid braking or gear changing in corners, especially when roads are wet. Ideally, corners should always be taken under gentle acceleration. If you follow these suggestions, tire wear will be held to a minimum.

## Driving at night



OCM053010

Because night driving presents more hazards than driving in the daylight, here are some important tips to remember:

- Slow down and keep more distance between you and other vehicles, as it may be more difficult to see at night, especially in areas where there may not be any street lights.
- Adjust your mirrors to reduce the glare from other driver's headlights.

- Keep your headlights clean and properly aimed on vehicles not equipped with the automatic headlight aiming feature. Dirty or improperly aimed headlights will make it much more difficult to see at night.
- Avoid staring directly at the headlights of oncoming vehicles. You could be temporarily blinded, and it will take several seconds for your eyes to readjust to the darkness.

تلفن شبانه روزی: ۰۲۱-۸۸۸۶۲۰۸۵

FarmaSOS.com

## Driving in the rain



1VQA3003

Rain and wet roads can make driving dangerous, especially if you're not prepared for the slick pavement. Here are a few things to consider when driving in the rain:

- A heavy rainfall will make it harder to see and will increase the distance needed to stop your vehicle, so slow down.
- Keep your windshield wiping equipment in good shape. Replace your windshield wiper blades when they show signs of streaking or missing areas on the windshield.

- If your tires are not in good condition, making a quick stop on wet pavement can cause a skid and possibly lead to an accident. Be sure your tires are in good shape.
- Turn on your headlights to make it easier for others to see you.
- Driving too fast through large puddles can affect your brakes. If you must go through puddles, try to drive through them slowly.
- If you believe you may have gotten your brakes wet, apply them lightly while driving until normal braking operation returns.

### Driving in flooded areas

Avoid driving through flooded areas unless you are sure the water is no higher than the bottom of the wheel hub. Drive through any water slowly. Allow adequate stopping distance because brake performance may be affected.

After driving through water, dry the brakes by gently applying them several times while the vehicle is moving slowly.

### Driving off-road

Drive carefully off-road because your vehicle may be damaged by rocks or roots of trees. Become familiar with the off-road conditions where you are going to drive before you begin driving.

### Highway driving

#### Tires

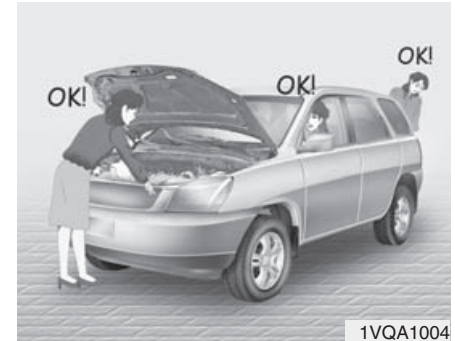

Adjust the tire inflation pressures to specification. Low tire inflation pressures will result in overheating and possible failure of the tires.

Avoid using worn or damaged tires which may result in reduced traction or tire failure.

#### \* NOTICE

Never exceed the maximum tire inflation pressure shown on the tires.

**⚠ WARNING**

- Underinflated or overinflated tires can cause poor handling, loss of vehicle control, and sudden tire failure leading to accidents, injuries, and even death. Always check the tires for proper inflation before driving. For proper tire pressures, refer to section 8, “Tires and wheels”.
- Driving on tires with no or insufficient tread is dangerous. Worn-out tires can result in loss of vehicle control, collisions, injury, and even death. Worn-out tires should be replaced as soon as possible and should never be used for driving. Always check the tire tread before driving your vehicle. For further information and tread limits, refer to section 7, “Tires and wheels”.

***Fuel, engine coolant and engine oil***

High speed travel consumes more fuel than urban motoring. Do not forget to check both engine coolant and engine oil.

***Drive belt***

A loose or damaged drive belt may result in overheating of the engine.

تلفن شبانه روزی: ۰۲۱-۸۸۸۶۲۰۸۵

FarmaSOS.com

## WINTER DRIVING



1VQA3005

Severe weather conditions in the winter result in greater wear and other problems. To minimize the problems of winter driving, you should follow these suggestions:

### Snowy or Icy conditions

To drive your vehicle in deep snow, it may be necessary to use snow tires or to install tire chains on your tires. If snow tires are needed, it is necessary to select tires equivalent in size and type of the original equipment tires. Failure to do so may adversely affect the safety and handling of your vehicle. Furthermore, speeding, rapid acceleration, sudden brake applications, and sharp turns are potentially very hazardous practices.

During deceleration, use engine braking to the fullest extent. Sudden brake applications on snowy or icy roads may cause skids to occur. You need to keep sufficient distance between the vehicle in operation in front and your vehicle. Also, apply the brake gently. It should be noted that installing tire chains on the tire will provide a greater driving force, but will not prevent side skids.

### \* NOTICE

**Tire chains are not legal in all countries. Check the country laws before fitting tire chains.**

### Snow tires

If you mount snow tires on your vehicle, make sure they are radial tires of the same size and load range as the original tires. Mount snow tires on all four wheels to balance your vehicle's handling in all weather conditions. Keep in mind that the traction provided by snow tires on dry roads may not be as high as your vehicle's original equipment tires. You should drive cautiously even when the roads are clear. Check with the tire dealer for maximum speed recommendations.

### **⚠ WARNING - Snow tire size**

**Snow tires should be equivalent in size and type to the vehicle's standard tires. Otherwise, the safety and handling of your vehicle may be adversely affected.**

*Do not install studded tires without first checking local, state and municipal regulations for possible restrictions against their use.*

**Tire chains**

1VQA3007

Since the sidewalls of radial tires are thinner, they can be damaged by mounting some types of snow chains on them. Therefore, the use of snow tires is recommended instead of snow chains. Do not mount tire chains on vehicles equipped with aluminum wheels; snow chains may cause damage to the wheels. If snow chains must be used, use wire-type chains with a thickness of less than 15 mm (0.59 in). Damage to your vehicle caused by improper snow chain use is not covered by your vehicle manufacturers warranty.

When using tire chains, attach them to the drive wheels as follows.

2WD : Front wheels

4WD : All four wheels

If a full set of chains is not available for an 4WD vehicle, chains may be installed on the front wheels only.

امداد خودرو فارما

تلفن شبانه روزی: ۰۲۱-۸۸۸۶۲۰۸۵

FarmaSOS.com

**⚠ CAUTION**

- ***Make sure the snow chains are the correct size and type for your tires. Incorrect snow chains can cause damage to the vehicle body and suspension and may not be covered by your vehicle manufacturer warranty. Also, the snow chain connecting hooks may be damaged from contacting vehicle components causing the snow chains to come loose from the tire. Make sure the snow chains are SAE class "S" certified.***
- ***Always check chain installation for proper mounting after driving approximately 0.5 to 1 km (0.3 to 0.6 miles) to ensure safe mounting. Retighten or remount the chains if they are loose.***



### Chain installation

When installing chains, follow the manufacturer's instructions and mount them as tightly as you can. Drive slowly with chains installed. If you hear the chains contacting the body or chassis, stop and tighten them. If they still make contact, slow down until it stops. Remove the chains as soon as you begin driving on cleared roads.

#### **WARNING** - Mounting chains

When mounting snow chains, park the vehicle on level ground away from traffic. Turn on the vehicle Hazard Warning flashers and place a triangular emergency warning device behind the vehicle if available. Always place the vehicle in P (Park), apply the parking brake and turn off the engine before installing snow chains.

#### **WARNING - Tire chains**

- **The use of chains may adversely affect vehicle handling.**
- **Do not exceed 30 km/h (20 mph) or the chain manufacturer's recommended speed limit, whichever is lower.**
- **Drive carefully and avoid bumps, holes, sharp turns, and other road hazards, which may cause the vehicle to bounce.**
- **Avoid sharp turns or locked-wheel braking.**

#### **CAUTION**

- ***Chains that are the wrong size or improperly installed can damage your vehicle's brake lines, suspension, body and wheels.***
- ***Stop driving and retighten the chains any time you hear them hitting the vehicle.***

### Use high quality ethylene glycol coolant

Your vehicle is delivered with high quality ethylene glycol coolant in the cooling system. It is the only type of coolant that should be used because it helps prevent corrosion in the cooling system, lubricates the water pump and prevents freezing. Be sure to replace or replenish your coolant in accordance with the maintenance schedule in section 7. Before winter, have your coolant tested to assure that its freezing point is sufficient for the temperatures anticipated during the winter.

### Check battery and cables

Winter puts additional burdens on the battery system. Visually inspect the battery and cables as described in section 7. We recommend that the level of charge in your battery be checked by an authorized HYUNDAI dealer.

**Change to "winter weight" oil if necessary**

In some climates it is recommended that a lower viscosity "winter weight" oil be used during cold weather. See section 8 for recommendations. If you aren't sure what weight oil you should use, we recommend that you consult an authorized HYUNDAI dealer.

**Check spark plugs and ignition system**

Inspect your spark plugs as described in section 7 and replace them if necessary. Also check all ignition wiring and components to be sure they are not cracked, worn or damaged in any way.

**To keep locks from freezing**

To keep the locks from freezing, squirt an approved de-icer fluid or glycerine into the key opening. If a lock is covered with ice, squirt it with an approved de-icing fluid to remove the ice. If the lock is frozen internally, you may be able to thaw it out by using a heated key. Handle the heated key with care to avoid injury.

**Use approved window washer anti-freeze in system**

To keep the water in the window washer system from freezing, add an approved window washer anti-freeze solution in accordance with instructions on the container. Window washer anti-freeze is available from an authorized HYUNDAI dealer and most auto parts outlets. Do not use engine coolant or other types of anti-freeze as these may damage the paint finish.

**Don't let your parking brake freeze**

Under some conditions your parking brake can freeze in the engaged position. This is most likely to happen when there is an accumulation of snow or ice around or near the rear brakes or if the brakes are wet. If there is a risk the parking brake may freeze, apply it only temporarily while you put the shift lever in P (automatic transaxle) or in first or reverse gear (manual transaxle) and block the rear wheels so the vehicle cannot roll. Then release the parking brake.

**Don't let ice and snow accumulate underneath**

Under some conditions, snow and ice can build up under the fenders and interfere with the steering. When driving in severe winter conditions where this may happen, you should periodically check underneath the vehicle to be sure the movement of the front wheels and the steering components is not obstructed.

### Carry emergency equipment

Depending on the severity of the weather, you should carry appropriate emergency equipment. Some of the items you may want to carry include tire chains, tow straps or chains, flashlight, emergency flares, sand, shovel, jumper cables, window scraper, gloves, ground cloth, coveralls, blanket, etc.

امداد خودرو فارما

تلفن شبانه روزی: ۰۲۱-۸۸۸۶۲۰۸۵

FarmaSOS.com

## TRAILER TOWING

If you are considering towing with your vehicle, you should first check with your country's Department of Motor Vehicles to determine their legal requirements.

Since laws vary the requirements for towing trailers, cars, or other types of vehicles or apparatus may differ. We recommend that you ask an authorized HYUNDAI dealer.

### **WARNING - Towing a trailer**

If you don't use the correct equipment and/or drive improperly, you can lose control when you pull a trailer. For example, if the trailer is too heavy, the brakes may not work well - or even at all. You and your passengers could be seriously or fatally injured. Pull a trailer only if you have followed all the steps in this section.

### **WARNING - Weight limits**

Before towing, make sure the total trailer weight, GCW (gross combination weight), GVW (gross vehicle weight), GAW (gross axle weight ) and trailer tongue load are all within the limits.

### \* **NOTICE - For Europe**

- The technically permissible maximum load on the rear axle(s) may be exceeded by not more than 15 % and the technically permissible maximum laden mass of the vehicle may be exceeded by not more than 10 % or 100 kg (220.4 lbs), whichever value is lower. In this case, do not exceed 100 km/h (62.1 mph) for vehicle of category M1 or 80 km/h (49.7 mph) for vehicle of category N1.

(Continued)

(Continued)

- When a vehicle of category M1 is towing a trailer, the additional load imposed at the trailer coupling device may cause the tire maximum load ratings to be exceeded, but not by more than 15 %. In this case, do not exceed 100 km/h (62.1 mph) and increase the tire inflation pressure by at least 0.2 bar.

### **CAUTION**

*Pulling a trailer improperly can damage your vehicle and result in costly repairs not covered by your warranty. To pull a trailer correctly, follow the advice in this section.*

Your vehicle can tow a trailer. To identify what the vehicle trailering capacity is for your vehicle, you should read the information in "Weight of the trailer" that appears later in this section.

Remember that trailering is different than just driving your vehicle by itself. Trailering means changes in handling, durability, and fuel economy. Successful, safe trailering requires correct equipment, and it has to be used properly.

This section contains many time-tested, important trailering tips and safety rules. Many of these are important for your safety and that of your passengers. Please read this section carefully before you pull a trailer.

Load-pulling components such as the engine, transaxle, wheel assemblies, and tires are forced to work harder against the load of the added weight. The engine is required to operate at relatively higher speeds and under greater loads. This additional burden generates extra heat. The trailer also considerably adds wind resistance, increasing the pulling requirements.

امداد خودرو فارما

تلفن شبانه روزی: ۰۲۱-۸۸۸۶۲۰۸۵

FarmaSOS.com

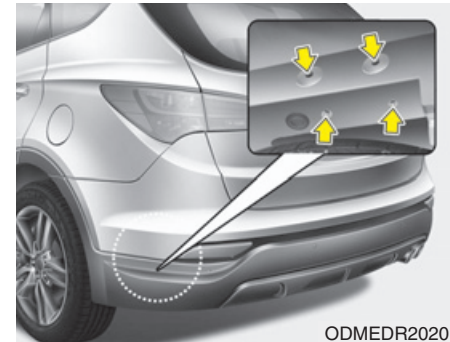

### \* NOTICE - Location of trailer mounting

The mounting hole for hitches are located on both sides of the underbody behind the rear tires.

## Hitches

It's important to have the correct hitch equipment. Crosswinds, large trucks going by, and rough roads are a few reasons why you'll need the right hitch. Here are some rules to follow:

- Do you have to make any holes in the body of your vehicle when you install a trailer hitch? If you do, then be sure to seal the holes later when you remove the hitch.  
If you do not seal them, deadly carbon monoxide (CO) from your exhaust can get into your vehicle, as well as dirt and water.
- The bumpers on your vehicle are not intended for hitches. Do not attach rental hitches or other bumper-type hitches to them. Use only a frame-mounted hitch that does not attach to the bumper.
- HYUNDAI trailer hitch accessory is available at an authorized HYUNDAI dealer.

## Safety chains

You should always attach chains between your vehicle and your trailer. Cross the safety chains under the tongue of the trailer so that the tongue will not drop to the road if it becomes separated from the hitch.

Instructions about safety chains may be provided by the hitch manufacturer or by the trailer manufacturer. Follow the manufacturer's recommendation for attaching safety chains. Always leave just enough slack so you can turn with your trailer. And, never allow safety chains to drag on the ground.

FarmaSOS.com

## Trailer brakes

If your trailer is equipped with a braking system, make sure it conforms to your country's regulations and that it is properly installed and operating correctly.

If your trailer weight exceeds the maximum allowed weight without trailer brakes, then the trailer will also require its own brakes as well. Be sure to read and follow the instructions for the trailer brakes so you'll be able to install, adjust and maintain them properly.

- Do not tap into or modify your vehicle's brake system.

### **WARNING - Trailer brakes**

**Do not use a trailer with its own brakes unless you are absolutely certain that you have properly set up the brake system. This is not a task for amateurs. Use an experienced, competent trailer shop for this work.**

### **Driving with a trailer**

Towing a trailer requires a certain amount of experience. Before setting out for the open road, you must get to know your trailer. Acquaint yourself with the feel of handling and braking with the added weight of the trailer. And always keep in mind that the vehicle you are driving is now a good deal longer and not nearly so responsive as your vehicle is by itself.

Before you start, check the trailer hitch and platform, safety chains, electrical connector(s), lights, tires and mirror adjustment. If the trailer has electric brakes, start your vehicle and trailer moving and then apply the trailer brake controller by hand to be sure the brakes are working. This lets you check your electrical connection at the same time.

During your trip, check occasionally to be sure that the load is secure, and that the lights and any trailer brakes are still working.

### ***Following distance***

Stay at least twice as far behind the vehicle ahead as you would when driving your vehicle without a trailer. This can help you avoid situations that require heavy braking and sudden turns.

### ***Passing***

You'll need more passing distance up ahead when you're towing a trailer. And, because of the increased vehicle length, you'll need to go much farther beyond the passed vehicle before you can return to your lane. Due to the added load to the engine when going uphill the vehicle may also take longer to pass than it would on flat ground.

### ***Backing up***

Hold the bottom of the steering wheel with one hand. Then, to move the trailer to the left, just move your hand to the left. To move the trailer to the right, move your hand to the right. Always back up slowly and, if possible, have someone guide you.

### ***Making turns***

When you're turning with a trailer, make wider turns than normal. Do this so your trailer won't strike soft shoulders, curbs, road signs, trees, or other objects near the edge of the road. Avoid jerky or sudden maneuvers. Signal well in advance before turning or lane changes.

**Turn signals when towing a trailer**

When you tow a trailer, your vehicle has to have a different turn signal flasher and extra wiring. The green arrows on your instrument panel will flash whenever you signal a turn or lane change. Properly connected, the trailer lights will also flash to alert other drivers you're about to turn, change lanes, or stop.

When towing a trailer, the green arrows on your instrument panel will flash for turns even if the bulbs on the trailer are burned out. Thus, you may think drivers behind you are seeing your signals when, in fact, they are not. It is important to check occasionally to be sure the trailer bulbs are still working. You must also check the lights every time you disconnect and then reconnect the wires.

Do not connect a trailer lighting system directly to your vehicle's lighting system. Use only an approved trailer wiring harness.

An authorized HYUNDAI dealer can assist you in installing the wiring harness.

**WARNING**

**Failure to use an approved trailer wiring harness could result in damage to the vehicle electrical system and/or personal injury.**

امداد خودرو فارما

تلفن شبانه روزی: ۰۲۱-۸۸۸۶۲۰۸۵

FarmaSOS.com

**Driving on grades**

Reduce speed and shift to a lower gear before you start down a long or steep downgrade. If you don't shift down, you might have to use your brakes so much that they would get hot and no longer operate efficiently.

On a long uphill grade, shift down and reduce your speed to around 70 km/h (45 mph) to reduce the possibility of engine and transaxle overheating.

If your trailer weighs more than the maximum trailer weight without trailer brakes and you have an automatic transaxle, you should drive in D (Drive) when towing a trailer.

Operating your vehicle in D (Drive) when towing a trailer will minimize heat build up and extend the life of your transaxle.



**⚠ CAUTION**

- ***When towing a trailer on steep grades (in excess of 6%) pay close attention to the engine coolant temperature gauge to ensure the engine does not overheat.***

***If the needle of the coolant temperature gauge moves across the dial towards “130/H (HOT)”, pull over and stop as soon as it is safe to do so, and allow the engine to idle until it cools down. You may proceed once the engine has cooled sufficiently.***

- ***You must decide driving speed depending on trailer weight and uphill grade to reduce the possibility of engine and transaxle overheating.***

***Parking on hills***

Generally, if you have a trailer attached to your vehicle, you should not park your vehicle on a hill. People can be seriously or fatally injured, and both your vehicle and the trailer can be damaged if they unexpectedly roll down hill.

**⚠ WARNING - Parking on a hill**

**Parking your vehicle on a hill with a trailer attached could cause serious injury or death, should the trailer break loose or the brake stops working.**

However, if you ever have to park your trailer on a hill, here is how to do it:

1. Pull the vehicle into the parking space. Turn the steering wheel in the direction of the curb (right if headed down hill, left if headed up hill).

2. If the vehicle has a manual transaxle, place the car in neutral. If the vehicle has an automatic transaxle, place the car in P (Park).
3. Set the parking brake and shut off the vehicle.
4. Place chocks under the trailer wheels on the down hill side of the wheels.
5. Start the vehicle, hold the brakes, shift to neutral, release the parking brake and slowly release the brakes until the trailer chocks absorb the load.
6. Reapply the brakes, reapply the parking brake and shift the vehicle to R (Reverse) for manual transaxle or P (Park) for automatic transaxle.
7. Shut off the vehicle and release the vehicle brakes but leave the parking brake set.

**⚠ WARNING - Parking brake**

**It can be dangerous to get out of your vehicle if the parking brake is not firmly set.**

**If you have left the engine running, the vehicle can move suddenly. You or others could be seriously or fatally injured.**

**When you are ready to leave after parking on a hill**

1. With the manual transaxle in Neutral or automatic transaxle in P (Park), apply your brakes and hold the brake pedal down while you:
  - Start your engine;
  - Shift into gear; and
  - Release the parking brake.
2. Slowly remove your foot from the brake pedal.
3. Drive slowly until the trailer is clear of the chocks.
4. Stop and have someone pick up and store the chocks.

**Maintenance when trailer towing**

Your vehicle will need service more often when you regularly pull a trailer. Important items to pay particular attention to include engine oil, automatic transaxle fluid, axle lubricant and cooling system fluid. Brake condition is another important item to frequently check. Each item is covered in this manual, and the Index will help you find them quickly. If you're trailering, it is a good idea to review these sections before you start your trip.

Do not forget to also maintain your trailer and hitch. Follow the maintenance schedule that accompanied your trailer and check it periodically. Preferably, conduct the check at the start of each day's driving. Most importantly, all hitch nuts and bolts should be tight.

**⚠ CAUTION**

- *Due to higher load during trailer usage, overheating might occur in hot days or during uphill driving. If the coolant gauge indicates overheating, switch off the air conditioner and stop the vehicle in a safe area to cool down the engine.*
- *When towing check transaxle fluid more frequently.*

### If you do decide to pull a trailer

Here are some important points if you decide to pull a trailer:

- Consider using a sway control. You can ask a hitch dealer about sway control.
- Do not do any towing with your car during its first 2,000 km (1,200 miles) in order to allow the engine to properly break in. Failure to heed this caution may result in serious engine or transaxle damage.
- When towing a trailer, we recommend that you consult an authorized HYUNDAI dealer on additional requirements such as a towing kit, etc.
- Always drive your vehicle at a moderate speed (less than 100 km/h (60 mph)).
- On a long uphill grade, do not exceed 70 km/h (45 mph) or the posted towing speed limit, whichever is lower.
- The chart contains important considerations that have to do with weight:

Item		Engine		Diesel Engine (2.0L, 2.2L)	
		Gasoline Engine (2.4L)		M/T	A/T
Maximum trailer weight kg (lbs.)	Without brake System	750 (1653)	750 (1653)	750 (1653)	750 (1653)
	With brake System	2500 (5512)	2000 (4409)	2500 (5512)	2000 (4409)
Maximum permissible static vertical load on the coupling device kg (lbs.)		100 (220)	100 (220)	100 (220)	100 (220)
Recommended distance from rear wheel center to coupling point mm (Inch)			1,130 (44.5)		

M/T : Manual transaxle  
A/T : Automatic transaxle

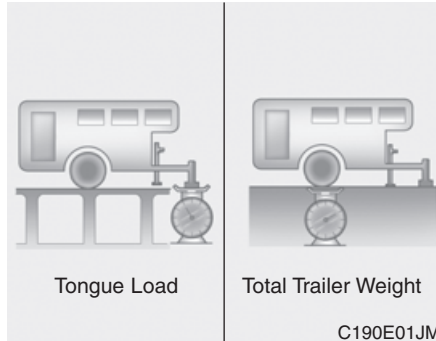
**Weight of the trailer**

What is the maximum safe weight of a trailer? It should never weigh more than the maximum trailer weight with trailer brakes. But even that can be too heavy.

It depends on how you plan to use your trailer. For example, speed, altitude, road grades, outside temperature and how often your vehicle is used to pull a trailer are all important. The ideal trailer weight can also depend on any special equipment that you have on your vehicle.

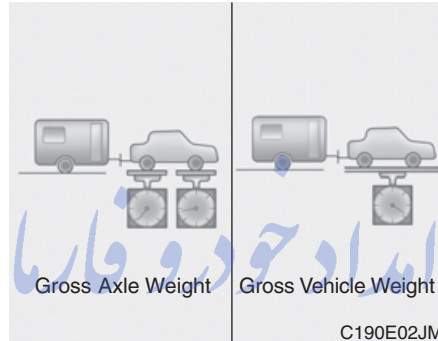
**Weight of the trailer tongue**

The tongue load of any trailer is an important weight to measure because it affects the total gross vehicle weight (GVW) of your vehicle. This weight includes the curb weight of the vehicle, any cargo you may carry in it, and the people who will be riding in the vehicle. And if you will tow a trailer, you must add the tongue load to the GVW because your vehicle will also be carrying that weight.

The trailer tongue should weigh a maximum of 10% of the total loaded trailer weight, within the limits of the maximum permissible trailer tongue load. After you've loaded your trailer, weigh the trailer and then the tongue, separately, to see if the weights are proper. If they aren't, you may be able to correct them simply by moving some items around in the trailer.

**⚠ WARNING - Trailer**

- Never load a trailer with more weight in the rear than in the front. The front should be loaded with approximately 60% of the total trailer load; the rear should be loaded with approximately 40% of the total trailer load.
- Never exceed the maximum weight limits of the trailer or trailer towing equipment. Improper loading can result in damage to your vehicle and/or personal injury. Check weights and loading at a commercial scale or highway patrol office equipped with scales.
- An improperly loaded trailer can cause loss of vehicle control.

امداد خودرو فارما

تلفن شبانه روزی: ۰۲۱-۸۸۸۶۲۰۸۵

FarmaSOS.com

## VEHICLE WEIGHT

This section will guide you in the proper loading of your vehicle and/or trailer, to keep your loaded vehicle weight within its design rating capability, with or without a trailer. Properly loading your vehicle will provide maximum return of the vehicle design performance. Before loading your vehicle, familiarize yourself with the following terms for determining your vehicle's weight ratings, with or without a trailer, from the vehicle's specifications and the certification label:

### Base curb weight

This is the weight of the vehicle including a full tank of fuel and all standard equipment. It does not include passengers, cargo, or optional equipment.

### Vehicle curb weight

This is the weight of your new vehicle when you picked it up from your dealer plus any aftermarket equipment.

### Cargo weight

This figure includes all weight added to the Base Curb Weight, including cargo and optional equipment.

### GAW (Gross axle weight)

This is the total weight placed on each axle (front and rear) - including vehicle curb weight and all payload.

### GAWR (Gross axle weight rating)

This is the maximum allowable weight that can be carried by a single axle (front or rear). These numbers are shown on the certification label.

The total load on each axle must never exceed its GAWR.

### GVW (Gross vehicle weight)

This is the Base Curb Weight plus actual Cargo Weight plus passengers.

### GVWR (Gross vehicle weight rating)

This is the maximum allowable weight of the fully loaded vehicle (including all options, equipment, passengers and cargo). The GVWR is shown on the certification label.

### Overloading

#### **WARNING - Vehicle weight**

The gross axle weight rating (GAWR) and the gross vehicle weight rating (GVWR) for your vehicle are on the certification label attached to the driver's (or front passenger's) door. Exceeding these ratings can cause an accident or vehicle damage. You can calculate the weight of your load by weighing the items (and people) before putting them in the vehicle. Be careful not to overload your vehicle.

# What to do in an emergency

Road warning .....	6-2	If you have a flat tire (with spare tire) .....	6-13
• Hazard warning flasher .....	6-2	• Jack and tools .....	6-13
In case of an emergency while driving .....	6-3	• Removing and storing the spare tire .....	6-14
• If the engine stalls at a crossroad or crossing ..	6-3	• Changing tires .....	6-16
• If you have a flat tire while driving .....	6-3	• Wheel nut tightening torque .....	6-19
• If engine stalls while driving .....	6-3	• Jack label .....	6-22
If the engine does not start .....	6-4	• EC declaration of conformity for jack .....	6-23
• If engine doesn't turn over or turns over		If you have a flat tire (with Tire Mobility Kit) ..	6-24
slowly .....	6-4	• Introduction .....	6-24
• If engine turns over normally but does not		• Components of the Tire Mobility Kit .....	6-25
start .....	6-4	• Using the Tire Mobility Kit .....	6-26
Emergency starting .....	6-5	• Distributing the sealant .....	6-28
• Jump starting .....	6-5	• Checking the tire inflation pressure .....	6-28
• Push-starting .....	6-6	• Notes on the safe use of the Tire Mobility Kit ..	6-29
If the engine overheats .....	6-7	• Technical Data .....	6-29
Tire Pressure Monitoring System (TPMS) .....	6-8	Towing .....	6-30
• Low tire pressure (position) telltale .....	6-9	• Towing service .....	6-30
• TPMS (Tire Pressure Monitoring System)		• Removable towing hook .....	6-31
malfunction indicator .....	6-11	• Emergency towing .....	6-32
• Changing a tire with TPMS .....	6-11	Emergency commodity .....	6-35
		• Fire extinguisher .....	6-35
		• First aid kit .....	6-35
		• Triangle reflector .....	6-35
		• Tire pressure gauge .....	6-35

### ROAD WARNING

#### Hazard warning flasher



The hazard warning flasher serves as a warning to other drivers to exercise extreme caution when approaching, overtaking, or passing your vehicle.

It should be used whenever emergency repairs are being made or when the vehicle is stopped near the edge of a roadway.

Depress the flasher switch with the ignition switch in any position. The flasher switch is located in the center console switch panel. All turn signal lights will flash simultaneously.

- The hazard warning flasher operates whether your vehicle is running or not.
- The turn signals do not work when the hazard flasher is on.
- Care must be taken when using the hazard warning flasher while the vehicle is being towed.

FarmaSOS.com



## IN CASE OF AN EMERGENCY WHILE DRIVING

### If the engine stalls at a cross-road or crossing

- If the engine stalls at a crossroad or crossing, set the shift lever in the N (Neutral) position and then push the vehicle to a safe place.
- If your vehicle has a manual transaxle not equipped with a ignition lock switch, the vehicle can move forward by shifting to the 2(second) or 3(third) gear and then turning the starter without depressing the clutch pedal.

### If you have a flat tire while driving

If a tire goes flat while you are driving:

1. Take your foot off the accelerator pedal and let the vehicle slow down while driving straight ahead. Do not apply the brakes immediately or attempt to pull off the road as this may cause a loss of control. When the vehicle has slowed to such a speed that it is safe to do so, brake carefully and pull off the road. Drive off the road as far as possible and park on firm, level ground. If you are on a divided highway, do not park in the median area between the two traffic lanes.
2. When the vehicle is stopped, turn on your emergency hazard flashers, set the parking brake and put the transaxle in P (automatic transaxle) or reverse (manual transaxle).
3. Have all passengers get out of the vehicle. Be sure they all get out on the side of the vehicle that is away from traffic.

4. When changing a flat tire, follow the instruction provided later in this section.

### If engine stalls while driving

1. Reduce your speed gradually, keeping a straight line. Move cautiously off the road to a safe place.
2. Turn on your emergency flashers.
3. Try to start the engine again. If your vehicle does not start, we recommend that you consult an authorized HYUNDAI dealer.

## IF THE ENGINE WILL NOT START

### If engine doesn't turn over or turns over slowly

- 1.If your vehicle has an automatic transaxle, be sure the shift lever is in N (Neutral) or P (Park) and the emergency brake is set.
- 2.Check the battery connections to be sure they are clean and tight.
- 3.Turn on the interior light. If the light dims or goes out when you operate the starter, the battery is discharged.
- 4.Check the starter connections to be sure they are securely tightened.
- 5.Do not push or pull the vehicle to start it. See instructions for "Jump starting".

#### **WARNING**

If the engine will not start, do not push or pull the vehicle to start it. This could result in a collision or cause other damage. In addition, push or pull starting may cause the catalytic converter to be overloaded and create a fire hazard.

### If engine turns over normally but does not start

- 1.Check fuel level.
- 2.With the ignition switch in the LOCK/OFF position, check all connectors at ignition, coil and spark plugs. Reconnect any that may be disconnected or loose.
- 3.Check the fuel line in the engine compartment.
- 4.If the engine still does not start, we recommend that you call an authorized HYUNDAI dealer.

تلفن شبانه روزی: ۰۲۱-۸۸۸۶۲۰۸۵

FarmaSOS.com

## EMERGENCY STARTING

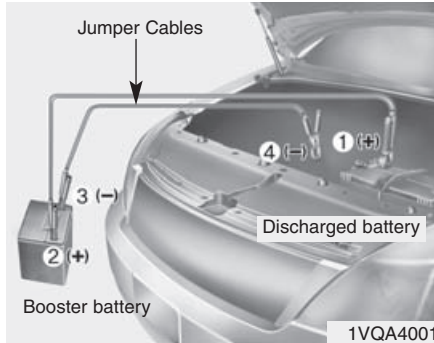

Connect cables in numerical order and disconnect in reverse order.

### Jump starting

Jump starting can be dangerous if done incorrectly. Therefore, to avoid harm to yourself or damage to your vehicle or battery, follow the jump starting procedures. If in doubt, we strongly recommend that you have a competent technician or towing service jump start your vehicle.

#### ⚠ CAUTION

*Use only a 12-volt jumper system. You can damage a 12-volt starting motor, ignition system, and other electrical parts beyond repair by use of a 24-volt power supply (either two 12-volt batteries in series or a 24-volt motor generator set).*

#### ⚠ WARNING - Battery

Never attempt to check the electrolyte level of the battery as this may cause the battery to rupture or explode causing serious injury.

#### ⚠ WARNING - Battery

- Keep all flames or sparks away from the battery. The battery produces hydrogen gas which may explode if exposed to flame or sparks. If these instructions are not followed exactly, serious personal injury and damage to the vehicle may occur! If you are not sure how to follow this procedure, seek qualified assistance. Automobile batteries contain sulfuric acid. This is poisonous and highly corrosive. When jump starting, wear protective glasses and be careful not to get acid on yourself, your clothing or on the vehicle.
- Do not attempt to jump start the vehicle if the discharged battery is frozen or if the electrolyte level is low; the battery may rupture or explode.
- Do not allow the (+) and (-) jumper cables to touch. It may cause sparks.
- The battery may rupture or explode when you jump start with a low or frozen battery.

### ***Jump starting procedure***

1. Make sure the booster battery is 12-volt and that its negative terminal is grounded.
2. If the booster battery is in another vehicle, do not allow the vehicles to touch.
3. Turn off all unnecessary electrical loads.
4. Connect the jumper cables in the exact sequence shown in the illustration. First connect one end of a jumper cable to the positive terminal of the discharged battery (1), then connect the other end to the positive terminal on the booster battery (2). Proceed to connect one end of the other jumper cable to the negative terminal of the booster battery (3), then the other end to a solid, stationary, metallic point (for example, the engine lifting bracket) away from the battery (4). Do not connect it to or near any part that moves when the engine is cranked.

Do not allow the jumper cables to contact anything except the correct battery terminals or the correct ground. Do not lean over the battery when making connections.

### **CAUTION - Battery cables**

***Do not connect the jumper cable from the negative terminal of the booster battery to the negative terminal of the discharged battery. This can cause the discharged battery to over-heat and crack, releasing battery acid.***

5. Start the engine of the vehicle with the booster battery and let it run at 2,000 rpm, then start the engine of the vehicle with the discharged battery.

*If the cause of your battery discharging is not apparent, we recommend that the system be checked by an authorized HYUNDAI dealer.*

### **Push-starting**

Your manual transaxle-equipped vehicle should not be push-started because it might damage the emission control system.

Vehicles equipped with automatic transaxle cannot be push-started.

Follow the directions in this section for jump-starting.

### **WARNING**

**Never tow a vehicle to start it because the sudden surge forward when the engine starts could cause a collision with the tow vehicle.**

## IF THE ENGINE OVERHEATS

If your temperature gauge indicates overheating, you will experience a loss of power, or hear loud pinging or knocking, the engine is probably too hot. If this happens, you should:

1. Pull off the road and stop as soon as it is safe to do so.
2. Place the shift lever in P (automatic transaxle) or neutral (manual transaxle) and set the parking brake. If the air conditioning is on, turn it off.
3. If engine coolant is running out under the vehicle or steam is coming out from the hood, stop the engine. Do not open the hood until the coolant has stopped running or the steaming has stopped. If there is no visible loss of engine coolant and no steam, leave the engine running and check to be sure the engine cooling fan is operating. If the fan is not running, turn the engine off.
4. Check to see if the water pump drive belt is missing. If it is not missing, check to see that it is tight.

If the drive belt seems to be satisfactory, check for coolant leaking from the radiator, hoses or under the vehicle. (If the air conditioning had been in use, it is normal for cold water to be draining from it when you stop).

### WARNING

**While the engine is running, keep hair, hands and clothing away from moving parts such as the fan and drive belts to prevent injury.**

5. If the water pump drive belt is broken or engine coolant is leaking out, stop the engine immediately and we recommend that you call an authorized HYUNDAI dealer.

### WARNING

**Do not remove the radiator cap when the engine is hot. This can allow coolant to blow out of the opening and cause serious burns.**

6. If you cannot find the cause of the overheating, wait until the engine temperature has returned to normal. Then, if coolant has been lost, carefully add coolant to the reservoir to bring the fluid level in the reservoir up to the halfway mark.
7. Proceed with caution, keeping alert for further signs of overheating. If overheating happens again, we recommend that you call an authorized HYUNDAI dealer.

### CAUTION

- ***Serious loss of coolant indicates there is a leak in the cooling system and we recommend that the system be checked by an authorized HYUNDAI dealer.***
- ***When the engine overheats from low engine coolant, suddenly adding engine coolant may cause cracks in the engine. To prevent damage, add engine coolant slowly in small quantities.***

## TIRE PRESSURE MONITORING SYSTEM (TPMS) (IF EQUIPPED)

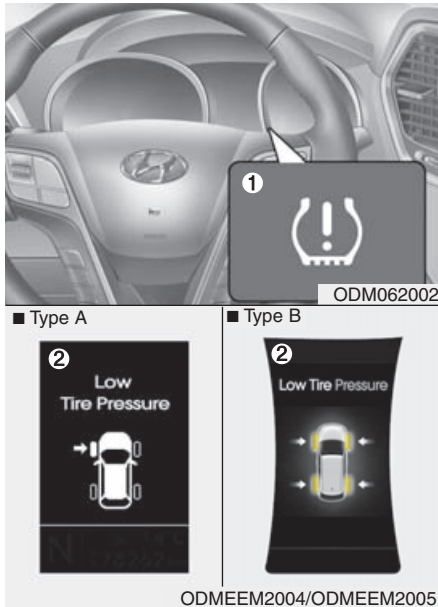

- (1) Low tire pressure telltale / TPMS malfunction indicator
- (2) Low tire pressure position telltale (Shown on the LCD display)

Each tire, including the spare (if provided), should be checked monthly when cold and inflated to the inflation pressure recommended by the vehicle manufacturer on the vehicle placard or tire inflation pressure label. (If your vehicle has tires of a different size than the size indicated on the vehicle placard or tire inflation pressure label, you should determine the proper tire inflation pressure for those tires.)

As an added safety feature, your vehicle has been equipped with a tire pressure monitoring system (TPMS) that illuminates a low tire pressure telltale when one or more of your tires is significantly under-inflated. Accordingly, when the low tire pressure telltale illuminates, you should stop and check your tires as soon as possible, and inflate them to the proper pressure. Driving on a significantly under-inflated tire causes the tire to overheat and can lead to tire failure. Under-inflation also reduces fuel efficiency and tire tread life, and may affect the vehicle's handling and stopping ability.

Please note that the TPMS is not a substitute for proper tire maintenance, and it is the driver's responsibility to maintain correct tire pressure, even if under-inflation has not reached the level to trigger illumination of the TPMS low tire pressure telltale.

Your vehicle has also been equipped with a TPMS malfunction indicator to indicate when the system is not operating properly. The TPMS malfunction indicator is combined with the low tire pressure telltale. When the system detects a malfunction, the telltale will flash for approximately one minute and then remain continuously illuminated. This sequence will continue upon subsequent vehicle start-ups as long as the malfunction exists. When the malfunction indicator is illuminated, the system may not be able to detect or signal low tire pressure as intended. TPMS malfunctions may occur for a variety of reasons, including the installation of replacement or alternate tires or wheels on the vehicle that prevent the TPMS from functioning properly.

Always check the TPMS malfunction telltale after replacing one or more tires or wheels on your vehicle to ensure that the replacement or alternate tires and wheels allow the TPMS to continue to function properly.

**\* NOTICE**

If any of the below happens, we recommend that the system be checked by an authorized HYUNDAI dealer.

1. The low tire pressure telltale/ TPMS malfunction indicator do not illuminate for 3 seconds when the ignition switch is turned to the ON position or engine is running.
2. The TPMS malfunction indicator remains illuminated after blinking for approximately 1 minute.
3. The Low tire pressure position telltale remains illuminated.

**Low tire pressure telltale**



**Low tire pressure position telltale**

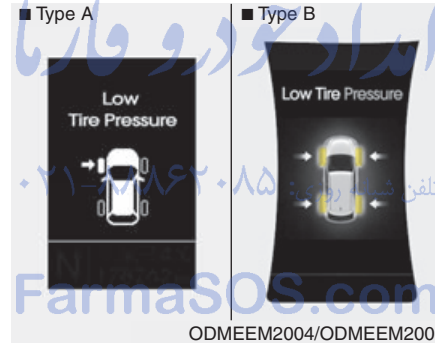

When the tire pressure monitoring system warning indicators are illuminated, and warning message displayed on the cluster LCD display, one or more of your tires is significantly under-inflated. The low tire pressure position telltale warning message will indicate which tire is significantly under-inflated by illuminating the corresponding position light.

If either telltale or LCD warning message displays immediately reduce your speed, avoid hard cornering and anticipate increased stopping distances. You should stop and check your tires as soon as possible.

Inflate the tires to the proper pressure as indicated on the vehicle's placard or tire inflation pressure label located on the driver's side center pillar outer panel.

If you cannot reach a service station or if the tire cannot hold the newly added air, replace the low pressure tire with a spare tire.

After you replace the low pressure tire with the spare tire, one of the following will happen:

- The TPMS malfunction indicator may blink for approximately 1 minute and then remain continuously illuminated because the TPMS sensor is not mounted on the spare wheel. (changed tire equipped with a sensor not in the vehicle)
- The TPMS malfunction indicator will remain continuously illuminated while driving because the TPMS sensor is not mounted on the spare wheel. (changed tire equipped with a sensor in the vehicle)

### CAUTION

*In winter or cold weather, the low tire pressure telltale may be illuminated if the tire pressure was adjusted to the recommended tire inflation pressure in warm weather. It does not mean your TPMS is malfunctioning because the decreased temperature leads to a proportional lowering of tire pressure.*

*When you drive your vehicle from a warm area to a cold area or from a cold area to a warm area, or the outside temperature is greatly higher or lower, you should check the tire inflation pressure and adjust the tires to the recommended tire inflation pressure.*

### WARNING - Low pressure damage

**Significantly low tire pressure makes the vehicle unstable and can contribute to loss of vehicle control and increased braking distances.**

**Continued driving on low pressure tires can cause the tires to overheat and fail.**





**TPMS (Tire Pressure Monitoring System) malfunction indicator**

The TPMS malfunction indicator will illuminate after it blinks for approximately one minute when there is a problem with the Tire Pressure Monitoring System.

We recommend that the system be checked by an authorized HYUNDAI dealer to determine the cause of the problem.

**\* NOTICE**

If there is a malfunction with the TPMS, the low tire pressure position telltale will not be displayed even though the vehicle has an under-inflated tire.

**Changing a tire with TPMS**

If you have a flat tire, the low Tire Pressure and Position telltales will come on. We recommend that the system be checked by an authorized HYUNDAI dealer.

**⚠ CAUTION**

*We recommend that you use the sealant approved by HYUNDAI. The sealant on the tire pressure sensor and wheel shall be eliminated when you replace the tire with a new one.*

Each wheel is equipped with a tire pressure sensor mounted inside the tire behind the valve stem. You must use TPMS specific wheels. It is recommended that you have your tires serviced by an authorized HYUNDAI dealer.

If you drive the vehicle for about 10 minutes at speeds above 25 km/h after replacing the low pressure tire with the spare tire, one of the following will happen:

- The TPMS malfunction indicator may blink for approximately 1 minute and then remain continuously illuminated because the TPMS sensor is not mounted on the spare wheel. (changed tire equipped with a sensor not in the vehicle)
- The TPMS malfunction indicator will remain continuously illuminated while driving because the TPMS sensor is not mounted on the spare wheel. (changed tire equipped with a sensor in the vehicle)

You may not be able identify a low tire by simply looking at it. Always use a good quality tire pressure gauge to measure the tire's inflation pressure. Please note that a tire that is hot (from being driven) will have a higher pressure measurement than a tire that is cold (from sitting stationary for at least 3 hours and driven less than 1 mile (1.6 km) during that 3 hour period).

Allow the tire to cool before measuring the inflation pressure. Always be sure the tire is cold before inflating to the recommended pressure.

A cold tire means the vehicle has been sitting for 3 hours and driven for less than 1 mile (1.6 km) in that 3 hour period.

### CAUTION

*We recommend that you use the sealant approved by HYUNDAI if your vehicle is equipped with a Tire Pressure Monitoring System. The liquid sealant can damage the tire pressure sensors.*

### WARNING - TPMS

- The TPMS cannot alert you to severe and sudden tire damage caused by external factors such as nails or road debris.
- If you feel any vehicle instability, immediately take your foot off the accelerator, apply the brakes gradually and with light force, and slowly move to a safe position off the road.

### WARNING - Protecting TPMS

Tampering with, modifying, or disabling the Tire Pressure Monitoring System (TPMS) components may interfere with the system's ability to warn the driver of low tire pressure conditions and/or TPMS malfunctions. Tampering with, modifying, or disabling the Tire Pressure Monitoring System (TPMS) components may void the warranty for that portion of the vehicle.

### WARNING - For EUROPE

- Do not modify the vehicle, it may interfere with the TPMS function.
  - The wheels on the market do not have a TPMS sensor.  
For your safety, we recommend that you use parts for replacement from an authorized HYUNDAI dealer.
  - If you use the wheels on the market, use a TPMS sensor approved by a HYUNDAI dealer. If your vehicle is not equipped with a TPMS sensor or TPMS does not work properly, you may fail the periodic vehicle inspection conducted in your country.
- \* All vehicles sold in the EUROPE market during below period must be equipped with TPMS.
- New model vehicle :  
Nov. 1, 2012 ~
  - Current model vehicle :  
Nov. 1, 2014~ (Based on vehicle registrations)

## IF YOU HAVE A FLAT TIRE (WITH SPARE TIRE, IF EQUIPPED)

### Jack and tools

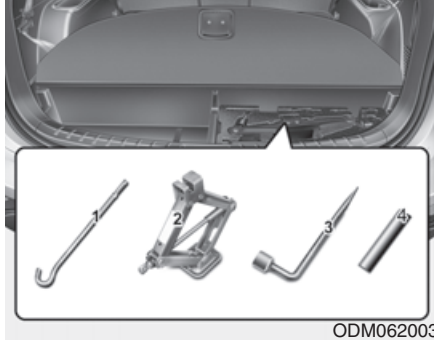

The jack, jack handle, wheel lug nut wrench are stored in the luggage compartment.

Pull up the luggage box cover to reach this equipment.

- (1) Jack handle
- (2) Jack
- (3) Wheel lug nut wrench
- (4) Socket

### Jacking instructions

The jack is provided for emergency tire changing only.

To prevent the jack from “rattling” while the vehicle is in motion, store it properly.

Follow jacking instructions to reduce the possibility of personal injury.

امداد خودرو فارما

تلفن شبانه روزی: ۰۲۱-۸۸۸۶۲۰۸۵

FarmaSOS.com

### **⚠ WARNING - Changing tires**

- **Never attempt vehicle repairs in the traffic lanes of a public road or highway.**
- **Always move the vehicle completely off the road and onto the shoulder before trying to change a tire. The jack should be used on firm level ground. If you cannot find a firm level place off the road, call a towing service company for assistance.**
- **Be sure to use the correct front and rear jacking positions on the vehicle; never use the bumpers or any other part of the vehicle for jacking support.**

(Continued)

### (Continued)

- The vehicle can easily roll off the jack causing serious injury or death.
- Do not get under a vehicle that is supported by a jack.
- Do not start or run the engine while the vehicle is on the jack.
- Do not allow anyone to remain in the vehicle while it is on the jack.
- Make sure any children present are in a secure place away from the road and from the vehicle to be raised with the jack.

### Removing and storing the spare tire

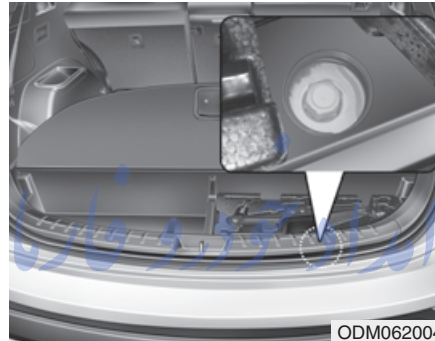

Your spare tire is stored underneath your vehicle, directly below the cargo area.

To remove the spare tire:

1. Open the tailgate.
2. Find the plastic hex bolt cover and remove the cover with coin or flat-blade screwdriver.

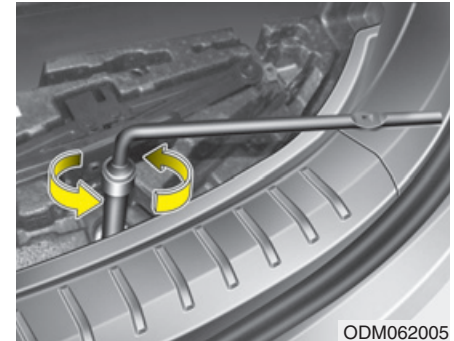

3. Connect the socket and wheel lug nut wrench.
4. Loosen the bolt enough to lower the spare tire.  
Turn the wrench counterclockwise until the spare tire reaches the ground.

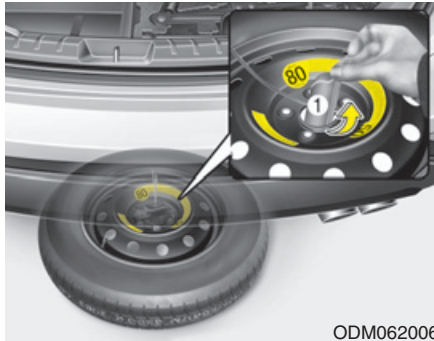

5. After the spare tire reaches the ground, continue to turn the wrench counterclockwise, and draw the spare tire outside. Never rotate the wrench excessively, otherwise the spare tire carrier may be damaged.
6. Remove the retainer (1) from the center of the spare tire.

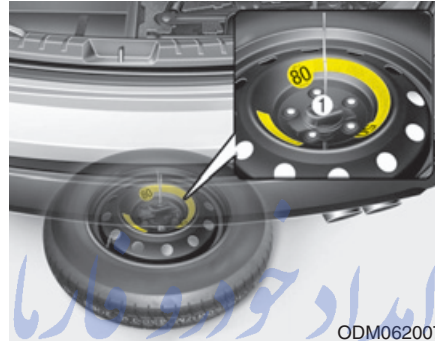

To store the spare tire:

1. Lay the tire on the ground with the valve stem facing up.
2. Place the wheel under the vehicle and install the retainer (1) through the wheel center.
3. Turn the wrench clockwise until it clicks.

**⚠ WARNING**

Ensure the spare tire retainer is properly aligned with the center of the spare tire to prevent the spare tire from “rattling”.

Otherwise, it may cause the spare tire to fall off the carrier and lead to an accident.

### Changing tires

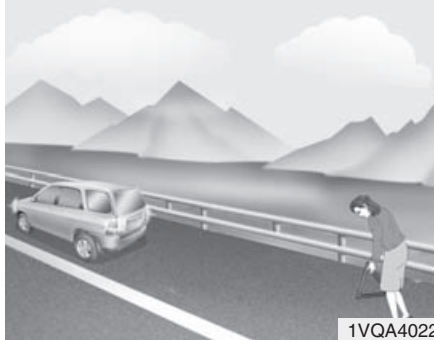

1. Park on a level surface and apply the parking brake firmly.
2. Shift the shift lever into R (Reverse) with manual transaxle or P (Park) with automatic transaxle.
3. Activate the hazard warning flasher.



4. Remove the wheel lug nut wrench, jack, jack handle, and spare tire from the vehicle.
5. Block both the front and rear of the wheel that is diagonally opposite the jack position.

FarmaSOS.com

### **⚠ WARNING - Changing a tire**

- To prevent vehicle movement while changing a tire, always set the parking brake fully, and always block the wheel diagonally opposite the wheel being changed.
- We recommend that the wheels of the vehicle be chocked, and that no person remain in a vehicle that is being jacked.



ODM062008

6. Loosen the wheel lug nuts counter-clockwise one turn each, but do not remove any nut until the tire has been raised off the ground.



ODM062009

7. Place the jack at the front or rear jacking position closest to the tire you are changing. Place the jack at the designated locations under the frame. The jacking positions are plates welded to the frame with two tabs and a raised dot to index with the jack.

**⚠ WARNING - Jack location**

To reduce the possibility of injury, be sure to use only the jack provided with the vehicle and in the correct jack position; never use any other part of the vehicle for jack support.



ODM062010

8. Insert the jack handle into the jack and turn it clockwise, raising the vehicle until the tire just clears the ground. This measurement is approximately 30 mm (1.2 in). Before removing the wheel lug nuts, make sure the vehicle is stable and that there is no chance for movement or slippage.

9. Loosen the wheel nuts and remove them with your fingers. Slide the wheel off the studs and lay it flat so it cannot roll away. To put the wheel on the hub, pick up the spare tire, line up the holes with the studs and slide the wheel onto them. If this is difficult, tip the wheel slightly and get the top hole in the wheel lined up with the top stud. Then jiggle the wheel back and forth until the wheel can be slid over the other studs.

**⚠ WARNING**

**Wheels may have sharp edges. Handle them carefully to avoid possible severe injury. Before putting the wheel into place, be sure that there is nothing on the hub or wheel (such as mud, tar, gravel, etc.) that interferes with the wheel from fitting solidly against the hub.**

**If there is, remove it. If there is not good contact on the mounting surface between the wheel and hub, the wheel nuts could come loose and cause the loss of a wheel. Loss of a wheel may result in loss of control of the vehicle. This may cause serious injury or death.**

10. To reinstall the wheel, hold it on the studs, put the wheel nuts on the studs and tighten them finger tight. The nuts should be installed with their tapered small diameter ends directed inward. Jiggle the tire to be sure it is completely seated, then tighten the nuts as much as possible with your fingers again.
11. Lower the vehicle to the ground by turning the wheel nut wrench counterclockwise.





Then position the wrench as shown in the drawing and tighten the wheel nuts. Be sure the socket is seated completely over the nut. Do not stand on the wrench handle or use an extension pipe over the wrench handle.

Go around the wheel tightening every other nut until they are all tight. Then double-check each nut for tightness. After changing wheels, we recommend that the system be checked by an authorized HYUNDAI dealer.

### Wheel nut tightening torque:

Steel wheel & aluminium alloy wheel:  
9~11 kg.m (65~79 lb.ft)

If you have a tire gauge, remove the valve cap and check the air pressure. If the pressure is lower than recommended, drive slowly to the nearest service station and inflate to the correct pressure. If it is too high, adjust it until it is correct. Always reinstall the valve cap after checking or adjusting tire pressure. If the cap is not replaced, air may leak from the tire. If you lose a valve cap, buy another and install it as soon as possible.

After you have changed wheels, always secure the flat tire in its place and return the jack and tools to their proper storage locations.

### CAUTION

***Your vehicle has metric threads on the wheel studs and nuts. Make certain during wheel removal that the same nuts that were removed are reinstalled - or, if replaced, that nuts with metric threads and the same chamfer configuration are used. Installation of a non-metric thread nut on a metric stud or vice-versa will not secure the wheel to the hub properly and will damage the stud so that it must be replaced.***

***Note that most lug nuts do not have metric threads. Be sure to use extreme care in checking for thread style before installing aftermarket lug nuts or wheels. If in doubt, we recommend that you consult an authorized HYUNDAI dealer.***

### **⚠ WARNING - Wheel studs**

If the studs are damaged, they may lose their ability to retain the wheel. This could lead to the loss of the wheel and a collision resulting in serious injuries.

To prevent the jack, jack handle, wheel lug nut wrench and spare tire from rattling while the vehicle is in motion, store them properly.

### **⚠ WARNING - Inadequate spare tire pressure**

Check the inflation pressures as soon as possible after installing the spare tire. Adjust it to the specified pressure, if necessary. Refer to “Tires and wheels” in section 8.

### ***Important - use of compact spare tire (if equipped)***

Your vehicle is equipped with a compact spare tire. This compact spare tire takes up less space than a regular-size tire. This tire is smaller than a conventional tire and is designed for temporary use only.

### **⚠ CAUTION**

- *You should drive carefully when the compact spare is in use. The compact spare should be replaced by the proper conventional tire and rim at the first opportunity.*
- *The operation of this vehicle is not recommended with more than one compact spare tire in use at the same time.*

### **⚠ WARNING**

The compact spare tire is for emergency use only. Do not operate your vehicle on this compact spare at speeds over 80 km/h (50 mph). The original tire should be repaired or replaced as soon as is possible to avoid failure of the spare possibly leading to personal injury or death.

The compact spare should be inflated to 420 kPa (60 psi).

### **\* NOTICE**

Check the inflation pressure after installing the spare tire. Adjust it to the specified pressure, as necessary.

When using a compact spare tire, observe the following precautions:

- Under no circumstances should you exceed 80 km/h (50 mph); a higher speed could damage the tire.
- Ensure that you drive slowly enough for the road conditions to avoid all hazards. Any road hazard, such as a pothole or debris, could seriously damage the compact spare.
- Any continuous road use of this tire could result in tire failure, loss of vehicle control, and possible personal injury.
- Do not exceed the vehicle's maximum load rating or the load-carrying capacity shown on the sidewall of the compact spare tire.
- Avoid driving over obstacles. The compact spare tire diameter is smaller than the diameter of a conventional tire and reduces the ground clearance approximately 25 mm (1 inch), which could result in damage to the vehicle.
- Do not take this vehicle through an automatic car wash while the compact spare tire is installed.
- Do not use tire chains on the compact spare tire. Because of the smaller size, a tire chain will not fit properly. This could damage the vehicle and result in loss of the chain.
- The compact spare tire should not be installed on the front axle if the vehicle must be driven in snow or on ice.
- Do not use the compact spare tire on any other vehicle because this tire has been designed especially for your vehicle.
- The compact spare tire's tread life is shorter than a regular tire. Inspect your compact spare tire regularly and replace worn compact spare tires with the same size and design, mounted on the same wheel.
- The compact spare tire should not be used on any other wheels, nor should standard tires, snow tires, wheel covers or trim rings be used with the compact spare wheel. If such use is attempted, damage to these items or other car components may occur.
- Do not use more than one temporary spare tire at a time.
- Do not tow a trailer while the temporary spare tire is installed.

## Jack label

### ■ Example

#### • Type A

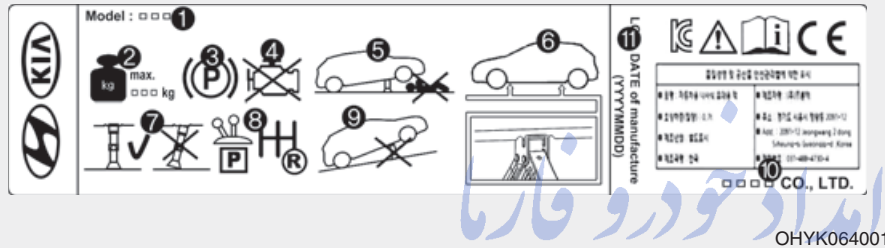

OHYK064001

#### • TypeB



OHYK064002

※ The actual Jack label in the vehicle may differ from the illustration.  
For more detailed specifications, refer to the label attached to the jack.

1. Model Name
2. Maximum allowable load
3. When using the jack, set your parking brake.
4. When using the jack, stop the engine.
5. Do not get under a vehicle that is supported by a jack.
6. The designated locations under the frame
7. When supporting the vehicle, the base plate of jack must be vertical under the lifting point.
8. Shift into Reverse gear on vehicles with manual transaxle or move the shift lever to the P position on vehicles with automatic transaxle.
9. The jack should be used on firm level ground.
10. Jack manufacture
11. Production date

## EC Declaration of Conformity for Jack



**EC Declaration of Conformity**  
according to EC Machinery Directive 2006/42/EC

We, **SAMKI IND. CO., LTD.**  
# 22, Hyojuk3-Gil, Buk-Gu, Ulsan, Korea  
declare under our sole responsibility that the product

**Product** : Jack Assembly  
**Type Designation(s)** : Jack Assembly-600kg, Jack Assembly-700kg  
 Jack Assembly-800kg, Jack Assembly-1000kg  
 Jack Assembly-1200kg, Jack Assembly-1500kg  
**Serial No.** : N/A  
**Year of Manufacture** : 2013

to which this declaration relates is in conformity with the following standard(s) or other normative document(s):

EN ISO12100 (2010)	Safety of machinery - General principles for design – Risk assessment and risk reduction
EN ISO12100-2/A1 (2009)	Safety of machinery - Basic concepts, general principles for design, Part 2 : Technical principles
EN 1494/A1 (2008)	Mobile or movable jacks and associated lifting equipment

following the provisions of Directive(s):

2006/42/EC Directive on the approximation of the laws of Member States relating to machinery (OJ L157 Jun. 9, 2006)

Ulsan, Korea / Jul 25, 2013 Hyun Duck Cho President 

(Place and date of issue)(name and signature or equivalent making of authorized person)

\* T.C.F Compiling Person: Safemert Limited (European Notified body : 1674 )  
Denford Garage, Denford, Kettering Northants, NN14 4BQ, England

امداد خودرو فارما

تلفن شبانه روزی: ۰۲۱-۸۸۸۹۲۰۸۵

FarmaSOS.com

JACKDOC14S

## IF YOU HAVE A FLAT TIRE (WITH TIRE MOBILITY KIT, IF EQUIPPED)



Please read the instructions before using the Tire Mobility Kit.

- (1) Compressor
- (2) Sealant bottle

The Tire Mobility Kit is a temporary fix to the tire and we recommend that the tire inspected by an authorized HYUNDAI dealer as soon as possible.

**⚠ CAUTION - One sealant for one tire**

*When two or more tires are flat, do not use the tire mobility kit because the supported one sealant of Tire Mobility Kit is only used for one flat tire.*

**⚠ WARNING - Tire wall**

**Do not use the Tire Mobility Kit to repair punctures in the tire walls. This can result in an accident due to tire failure.**

**⚠ WARNING - Temporary fix**

**Have your tire repaired as soon as possible. The tire may lose air pressure at any time after inflating with the Tire Mobility Kit.**

### Introduction



With the Tire Mobility Kit (TMK) you stay mobile even after experiencing a tire puncture.

The system of compressor and sealing compound effectively and comfortably seals most punctures in a passenger car tire caused by nails or similar objects and reinflates the tire.

After you ensured that the tire is properly sealed you can drive cautiously on the tire (up to 200 km (120 miles)) at a max. speed of 80 km/h (50 mph) in order to reach a vehicle or tire dealer to have the tire replaced.

It is possible that some tires, especially with larger punctures or damage to the sidewall, cannot be sealed completely.

Air pressure loss in the tire may adversely affect tire performance.

For this reason, you should avoid abrupt steering or other driving maneuvers, especially if the vehicle is heavily loaded or if a trailer is in use.

The TMK is not designed or intended as a permanent tire repair method and is to be used for one tire only.

This instruction shows you step by step how to temporarily seal the puncture simply and reliably.

Read the section "Notes on the safe use of the Tire Mobility Kit".

**⚠ WARNING**

**Do not use the TMK if a tire is severely damaged by driving run flat or with insufficient air pressure.**

**Only punctured areas located within the tread region of the tire can be sealed using the TMK.**

**Components of the Tire Mobility Kit (TMK)**

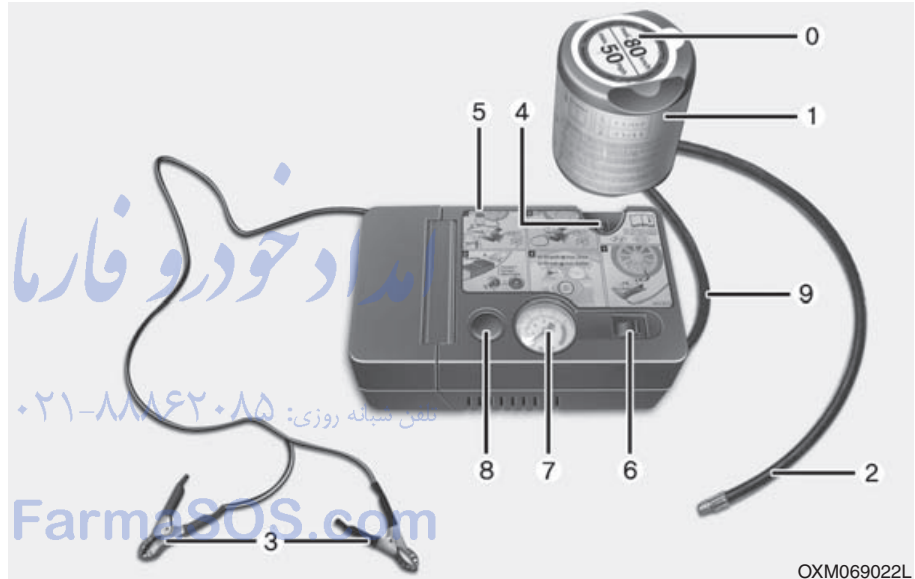

- |   |  |
|---|--|
| 0. Speed restriction label                                | 4. Holder for the sealant bottle                             |
| 1. Sealant bottle and label with speed restriction        | 5. Compressor  |
| 2. Filling hose from sealant bottle to wheel              | 6. On/off switch   |
| 3. Connectors and cable for the battery direct connection | 7. Pressure gauge for displaying the tire inflation pressure |

8. Button for reducing tire inflation pressure
9. Hose to connect compressor and sealant bottle or compressor and wheel

Connectors, cable and connection hose are stored in the compressor housing.

**⚠ WARNING - Expired sealant**

**Do not use the tire sealant after the sealant has expired (i.e. pasted the expiration date on the sealant container). This can increase the risk of tire failure.**

**⚠ WARNING - Sealant**

- **Keep out of reach of children.**
- **Avoid contact with eyes.**
- **Do not swallow.**

Strictly follow the specified sequence, otherwise the sealant may escape under high pressure.

### Using the TMK

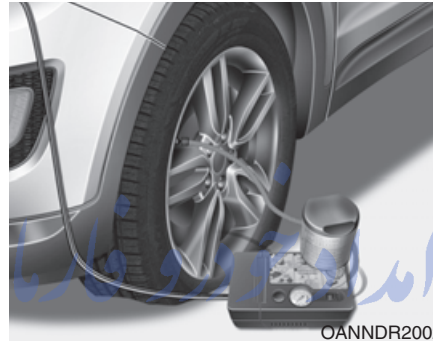

1. Detach the speed restriction label (0) from the sealant bottle (1), and place it in a highly visible place inside the vehicle such as on the steering wheel to remind the driver not to drive too fast.
2. Screw connection hose (9) onto the connector of the sealant bottle.
3. Ensure that button (8) on the compressor is not pressed.
4. Unscrew the valve cap from the valve of the flat tire and screw filling hose (2) of the sealant bottle onto the valve.

5. Insert the sealant bottle into the housing (4) of the compressor so that the bottle is upright.
6. Ensure that the compressor is switched off, position 0.





7. Connect TMK cables to the battery in numerical order.

- ① RED cable : (+) battery terminal
- ② BLACK cable : (-) battery terminal

**⚠ CAUTION**

• **TMK cable connection can be dangerous if done incorrectly. Therefore, to avoid harm to yourself or damage to TMK or battery, follow the TMK cable connection procedures.**

*(Continued)*

*(Continued)*

- **When disconnecting TMK cables, disconnect BLACK (-) cable first from the battery and then disconnect RED (+) cable.**
- **Be careful the spark from the battery when connect or disconnect the battery cables.**

8. With the engine start/stop button position on or ignition switch position on, switch on the compressor and let it run for approximately 5~7 minutes to fill the sealant up to proper pressure. (refer to the Tire and Wheels, section 8). The inflation pressure of the tire after filling is unimportant and will be checked/corrected later.

Be careful not to overinflate the tire and stay away from the tire when filling it.

**⚠ CAUTION - Tire pressure**

**Do not attempt to drive your vehicle if the tire pressure is below 29 PSI (200kpa). This could result in an accident due to sudden tire failure.**

9. Switch off the compressor.

10. Detach the hoses from the sealant bottle connector and from the tire valve.

Return the TMK to its storage location in the vehicle.

**⚠ WARNING - Carbon monoxide**

**Carbon monoxide poisoning and suffocation is possible if the engine is left running in a poorly ventilated or unventilated location (such as inside a building).**

### Distributing the sealant

11. Immediately drive approximately 7~10km (4~6miles or, about 10min) to evenly distribute the sealant in the tire.

#### CAUTION

*Do not exceed a speed of 60 km/h (35 mph). If possible, do not fall below a speed of 20 km/h (12 mph).*

*While driving, if you experience any unusual vibration, ride disturbance or noise, reduce your speed and drive with caution until you can safely pull off of the side of the road. Call for road side service or towing.*

*When you use the Tire Mobility Kit, the tire pressure sensors and wheel may be damaged by sealant, remove the sealant stained with tire pressure sensors and wheel and we recommend that inspect at an authorized HYUNDAI dealer.*

### Checking the tire inflation pressure

1. After driving approximately 7~10 km (4~6 miles or about 10 minutes), stop at a suitable location.
2. Connect connection hose (9) of the compressor directly to the tire valve.
3. Connect between compressor and the vehicle battery using the cable and connectors.
4. Adjust the tire inflation pressure to 200 kPa (29 psi). With the ignition switched on, proceed as follows.
  - **To increase the inflation pressure:** Switch on the compressor, position I. To check the current inflation pressure setting, briefly switch off the compressor.

#### WARNING

**Do not let the compressor run for more than 10 minutes, otherwise the device will overheat and may be damaged.**

- **To reduce the inflation pressure:** Press the button (8) on the compressor.

#### CAUTION

*If the inflation pressure is not maintained, drive the vehicle a second time, refer to Distributing the sealant. Then repeat steps 1 to 4.*

*Use of the TMK may be ineffective for tire damage larger than approximately 4 mm (0.16 in).*

*We recommend that you contact an authorized HYUNDAI dealer if the tire cannot be made road-worthy with the Tire Mobility Kit.*

#### WARNING

**The tire inflation pressure must be at least 200 kPa (29 psi). If it is not, do not continue driving.**

**Call for road side service or towing.**

### Notes on the safe use of the Tire Mobility Kit

- Park your car at the side of the road so that you can work with the TMK away from moving traffic. Place your warning triangle in a prominent place to make passing vehicles aware of your location.
- To be sure your vehicle will not move, even when you're on fairly level ground, always set your parking brake.
- Only use the TMK for sealing/inflation passenger car tires. Do not use on motorcycles, bicycles or any other type of tires.
- Do not remove any foreign objects- such as nails or screws -that have penetrated the tire.
- Before using the TMK, read the precautionary advice printed on the sealant bottle!
- Provided the car is outdoors, leave the engine running. Otherwise operating the compressor may eventually drain the car battery.

- Never leave the TMK unattended while it is being used.
- Do not leave the compressor running for more than 10 min. at a time or it may overheat.
- Do not use the TMK if the ambient temperature is below  $-30^{\circ}\text{C}$  ( $-22^{\circ}\text{F}$ ).
- When both the tire and wheel are damaged, do not use Tire Mobility Kit for your safety.

تلفن شبانه روزی: ۰۲۱-۸۸۸۶۲۰۸۵

FarmaSOS.com

### Technical Data

System voltage: DC 15 V

Working voltage: DC 10 - 15 V

Amperage rating: max. 20 A

Suitable for use at temperatures:

$-30 \sim +70^{\circ}\text{C}$  ( $-22 \sim +158^{\circ}\text{F}$ )

Max. working pressure:

6 bar (87 psi)

Size

Compressor: 220 x 130 x 80 mm  
(8.7 x 5.1 x 3.1 in.)

Sealant bottle: 165 x 85.5  $\varnothing$  mm  
(6.5 x 3.4  $\varnothing$  in.)

Compressor weight:

1.8 kg (3.97 lbs)

Sealant volume:

620 ml (37.8 cu. in.)

\* Sealant and spare parts can be obtained and replaced at an authorized vehicle or tire dealer. Empty sealant bottles may be disposed of at home. Liquid residue from the sealant should be disposed of by your vehicle or tire dealer or in accordance with local waste disposal regulations.

## TOWING

### Towing service

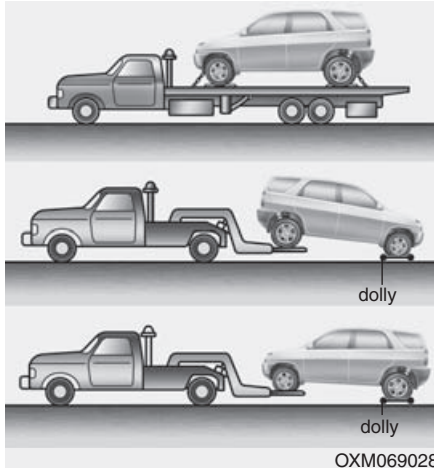

If emergency towing is necessary, we recommend having it done by an authorized HYUNDAI dealer or a commercial tow-truck service. Proper lifting and towing procedures are necessary to prevent damage to the vehicle. The use of wheel dollies or flatbed is recommended.

*For trailer towing guidelines information, refer to "Trailer towing" in section 5.*

On 4WD vehicles, your vehicle must be towed with a wheel lift and dollies or flatbed equipment with all the wheels off the ground.

### CAUTION

*The 4WD vehicle should never be towed with the wheels on the ground. This can cause serious damage to the transaxle or the 4WD system.*

On 2WD vehicles, it is acceptable to tow the vehicle with the rear wheels on the ground (without dollies) and the front wheels off the ground.

If any of the loaded wheels or suspension components are damaged or the vehicle is being towed with the front wheels on the ground, use a towing dolly under the front wheels.

When being towed by a commercial tow truck and wheel dollies are not used, the front of the vehicle should always be lifted, not the rear.

### **WARNING** - if equipped with rollover sensor

If your vehicle is equipped with side and curtain air bag, set the ignition switch to OFF or ACC position when the vehicle is being towed.

The side and curtain air bag may deploy when the ignition is ON, and the rollover sensor detects the situation as a rollover.

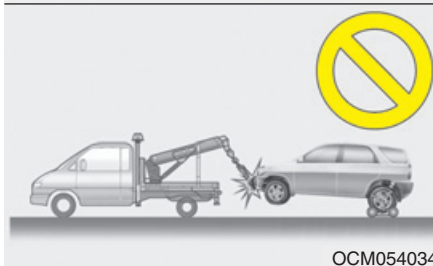
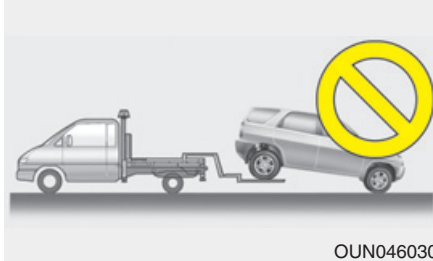

**CAUTION**

- Do not tow the vehicle backwards with the front wheels on the ground as this may cause damage to the vehicle.
- Do not tow with sling-type equipment. Use wheel lift or flatbed equipment.

When towing your vehicle in an emergency without wheel dollies :

- 1.Set the ignition switch in the ACC position.
- 2.Place the transaxle shift lever in N (Neutral).
- 3.Release the parking brake.

**CAUTION**

*Failure to place the transaxle shift lever in N (Neutral) may cause internal damage to the transaxle.*

تلفن شبانه روزی: ۰۲۱-۸۸۸۶۲۰۸۵

FarmaSOS.com

**Removable towing hook (if equipped)**

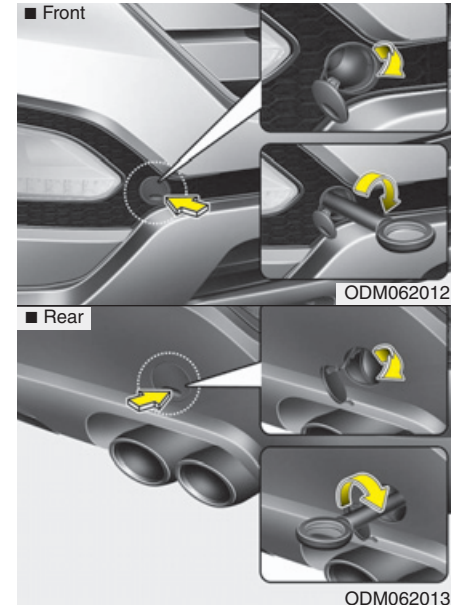

- 1.Open the tailgate, and remove the towing hook from the tool case.
- 2.Remove the hole cover pressing the lower part of the cover on the bumper.

3. Install the towing hook by turning it clockwise into the hole until it is fully secured.
4. Remove the towing hook and install the cover after use.

### Emergency towing

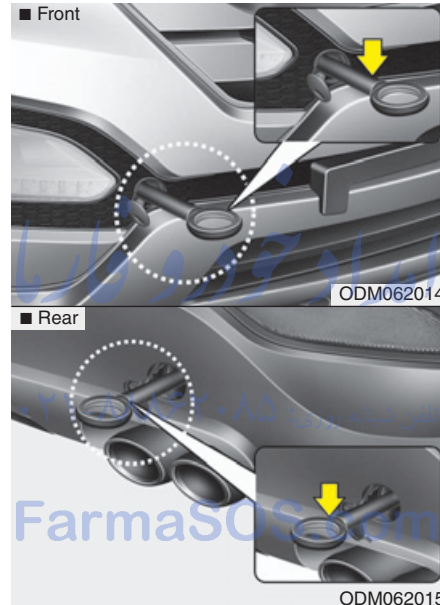

**If towing is necessary, we recommend you to have it done by an authorized HYUNDAI dealer or a commercial tow truck service.**

If towing service is not available in an emergency, your vehicle may be temporarily towed using a cable or chain secured to the emergency towing hook under the front (or rear) of the vehicle. Use extreme caution when towing the vehicle. A driver must be in the vehicle to steer it and operate the brakes.

Towing in this manner may be done only on hard-surfaced roads for a short distance and at low speed. Also, the wheels, axles, power train, steering and brakes must all be in good condition.

- Do not use the towing hooks to pull a vehicle out of mud, sand or other conditions from which the vehicle cannot be driven out under its own power.
- Avoid towing a vehicle heavier than the vehicle doing the towing.
- The drivers of both vehicles should communicate with each other frequently.

**⚠ CAUTION**

- *Attach a towing strap to the tow hook.*
- *Using a portion of the vehicle other than the tow hooks for towing may damage the body of your vehicle.*
- *Use only a cable or chain specifically intended for use in towing vehicles. Securely fasten the cable or chain to the towing hook provided.*

- Before emergency towing, check that the hook is not broken or damaged.
- Fasten the towing cable or chain securely to the hook.
- Do not jerk the hook. Apply steady and even force.
- To avoid damaging the hook, do not pull from the side or at a vertical angle. Always pull straight ahead.

**⚠ WARNING**

Use extreme caution when towing the vehicle.

- Avoid sudden starts or erratic driving maneuvers which would place excessive stress on the emergency towing hook and towing cable or chain. The hook and towing cable or chain may break and cause serious injury or damage.
- If the disabled vehicle is unable to be moved, do not forcibly continue the towing. We recommend that you contact an authorized HYUNDAI dealer or a commercial tow truck service for assistance.
- Tow the vehicle as straight ahead as possible.
- Keep away from the vehicle during towing.

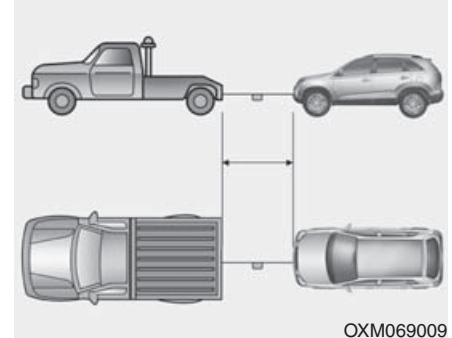

OXM069009

- Use a towing strap less than 5 m (16 feet) long. Attach a white or red cloth (about 30 cm (12 inches) wide) in the middle of the strap for easy visibility.
- Drive carefully so that the towing strap is not loosened during towing.

### ***Emergency towing precautions***

- Turn the ignition switch to ACC so the steering wheel isn't locked.
- Place the transaxle shift lever in N (Neutral).
- Release the parking brake.
- Press the brake pedal with more force than normal since you will have reduced brake performance.
- More steering effort will be required because the power steering system will be disabled.
- If you are driving down a long hill, the brakes may overheat and brake performance will be reduced. Stop often and let the brakes cool off.



### **CAUTION - Automatic transaxle**

- ***If the car is being towed with all four wheels on the ground, it can be towed only from the front. Be sure that the transaxle is in neutral. Be sure the steering is unlocked by placing the ignition switch in the ACC position. A driver must be in the towed vehicle to operate the steering and brakes.***
- ***To avoid serious damage to the automatic transaxle, limit the vehicle speed to 15 km/h (10 mph) and drive less than 1.5 km (1 mile) when towing.***
- ***Before towing, check the automatic transaxle for fluid leaks under your vehicle. If the automatic transaxle fluid is leaking, flatbed equipment or a towing dolly must be used.***



## EMERGENCY COMMODITY (IF EQUIPPED)

There are some emergency commodities in the vehicle to help you respond to the emergency situation.

### Fire extinguisher

If there is small fire and you know how to use the fire extinguisher, take the following steps carefully.

1. Pull the pin at the top of the extinguisher that keeps the handle from being accidentally pressed.
2. Aim the nozzle toward the base of the fire.
3. Stand approximately 2.5 m (8 ft) away from the fire and squeeze the handle to discharge the extinguisher. If you release the handle, the discharge will stop.
4. Sweep the nozzle back and forth at the base of the fire. After the fire appears to be out, watch it carefully since it may re-ignite.

### First aid kit

There are some items such as scissors, bandage and adhesive tape and etc. in the kit to give first aid to an injured person.

### Triangle reflector

Place the triangle reflector on the road to warn oncoming vehicles during emergencies, such as when the vehicle is parked by the roadside due to any problems.

تلفن شبانه روزی: ۰۲۱-۸۸۸۶۲۰۸۵

FarmaSOS.com

### Tire pressure gauge (If equipped)

Tires normally lose some air in day-to-day use, and you may have to add a few pounds of air periodically and it is not usually a sign of a leaking tire, but of normal wear. Always check tire pressure when the tires are cold because tire pressure increases with temperature.

To check the tire pressure, take the following steps;

1. Unscrew the inflation valve cap that is located on the rim of the tire.
2. Press and hold the gauge against the tire valve. Some air will escape as you begin and more will escape if you don't press the gauge in firmly.
3. A firm non-leaking push will activate the gauge.
4. Read the tire pressure on the gauge to know whether the tire pressure is low or high.
5. Adjust the tire pressures to the specified pressure. Refer to "Tires and wheels" in section 8.
6. Reinstall the inflation valve cap.

# Maintenance

<b>Engine compartment</b> . . . . .	7-3	<b>Parking brake</b> . . . . .	7-46
<b>Maintenance services</b> . . . . .	7-5	• Checking the parking brake . . . . .	7-46
• Owner's responsibility . . . . .	7-5	<b>Fuel filter (for Diesel)</b> . . . . .	7-47
• Owner maintenance precautions . . . . .	7-5	• Draining water from fuel filter . . . . .	7-47
• Engine compartment precautions (Diesel engine) . . . . .	7-7	<b>Air cleaner</b> . . . . .	7-48
<b>Owner maintenance</b> . . . . .	7-8	• Filter replacement . . . . .	7-48
• Owner maintenance schedule . . . . .	7-8	<b>Climate control air filter</b> . . . . .	7-50
<b>Scheduled maintenance service</b> . . . . .	7-10	• Filter inspection . . . . .	7-50
• For europe, Except Russia . . . . .	7-11	• Filter replacement . . . . .	7-50
• Except europe, For Russia . . . . .	7-22	<b>Wiper blades</b> . . . . .	7-52
<b>Explanation of scheduled maintenance items</b> . . . . .	7-34	• Blade inspection . . . . .	7-52
<b>Engine oil</b> . . . . .	7-38	• Blade replacement . . . . .	7-52
• Checking the engine oil level . . . . .	7-38	<b>Battery</b> . . . . .	7-55
• Changing the engine oil and filter . . . . .	7-39	• For best battery service . . . . .	7-55
<b>Engine coolant</b> . . . . .	7-40	• Battery capacity label . . . . .	7-56
• Checking the coolant level . . . . .	7-40	• Battery recharging . . . . .	7-57
• Changing the coolant . . . . .	7-42	• Reset items . . . . .	7-58
<b>Brake/clutch fluid</b> . . . . .	7-43	<b>Tires and wheels</b> . . . . .	7-58
• Checking the brake/clutch fluid level . . . . .	7-43	• Tire care . . . . .	7-58
<b>Power steering fluid</b> . . . . .	7-44	• Recommended cold tire inflation pressures . . . . .	7-58
• Checking the power steering fluid level . . . . .	7-44	• Checking tire inflation pressure . . . . .	7-60
• Checking the power steering hose . . . . .	7-44	• Tire rotation . . . . .	7-61
<b>Washer fluid</b> . . . . .	7-45	• Wheel alignment and tire balance . . . . .	7-62
• Checking the washer fluid level . . . . .	7-45	• Tire replacement . . . . .	7-62
		• Wheel replacement . . . . .	7-64

- Tire traction ..... 7-64
- Tire maintenance ..... 7-64
- Tire sidewall labeling ..... 7-64
- Low aspect ratio tire ..... 7-69
- Fuses ..... 7-70**
  - Fuse/relay panel description ..... 7-74
- Light bulbs ..... 7-87**
  - Front lamp replacement ..... 7-88
  - Side repeater lamp bulb replacement ..... 7-98
  - Rear combination lamp bulb replacement ..... 7-98
  - High mounted stop lamp bulb replacement ..... 7-101
  - License plate lamp bulb replacement ..... 7-102
  - Interior lamp bulb replacement ..... 7-103
- Appearance care ..... 7-104**
  - Exterior care ..... 7-104
  - Interior care ..... 7-109
- Emission control system ..... 7-111**

امداد خودرو فارما

تلفن شبانه روزی: ۰۲۱-۸۸۶۲۰۸۵

FarmaSOS.com

## ENGINE COMPARTMENT

### ■ Gasoline Engine (Theta II 2.4L) - GDI

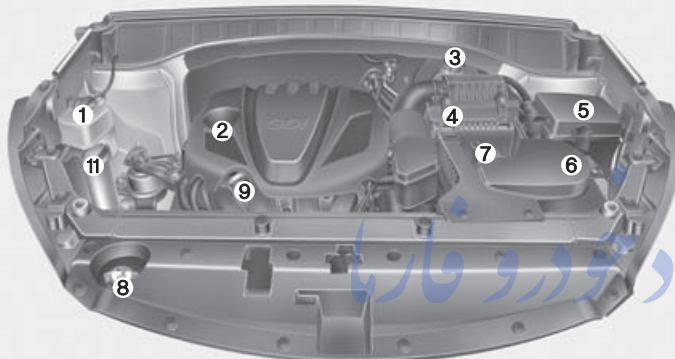

1. Engine coolant reservoir
2. Engine oil filler cap
3. Brake/clutch fluid reservoir
4. Air cleaner
5. Fuse box
6. Negative battery terminal
7. Positive battery terminal
8. Radiator cap
9. Engine oil dipstick
10. Power steering fluid reservoir (if equipped)
11. Windshield washer fluid reservoir

### ■ Gasoline Engine (Theta II 2.4L) - MPI

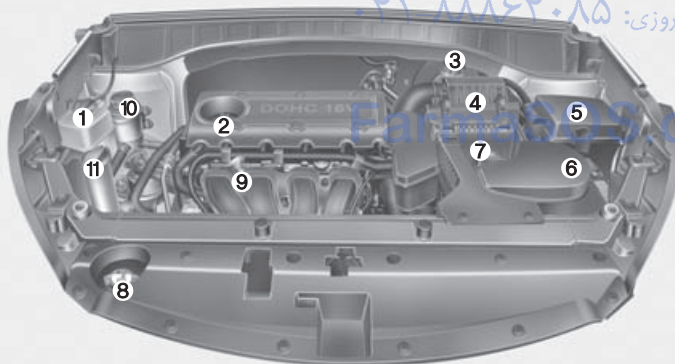

\* The actual engine room in the vehicle may differ from the illustration.

ODMEMC2001/ODMNM2020

## ■ Gasoline Engine (Lambda II 3.3L) - MPI

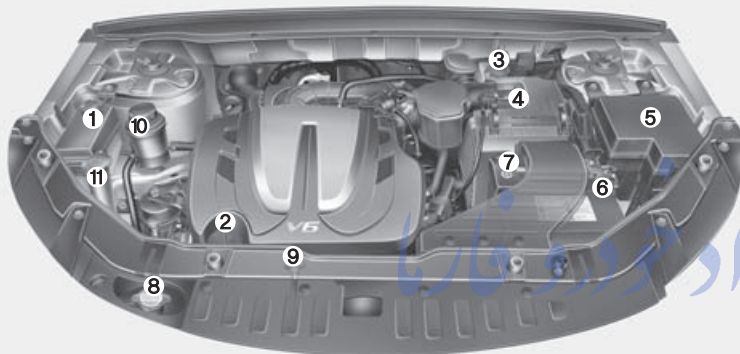

1. Engine coolant reservoir
2. Engine oil filler cap
3. Brake/clutch fluid reservoir
4. Air cleaner
5. Fuse box
6. Negative battery terminal
7. Positive battery terminal
8. Radiator cap
9. Engine oil dipstick
10. Power steering fluid reservoir (if equipped)
11. Windshield washer fluid reservoir

## ■ Diesel Engine (R2.0/R2.2)

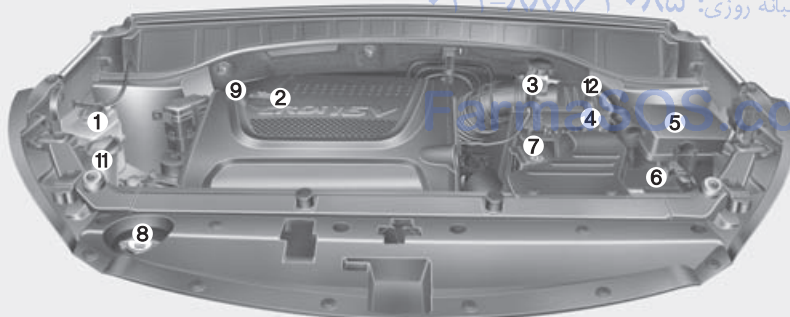

\* The actual engine room in the vehicle may differ from the illustration.

OXM079100/ODM012005

## MAINTENANCE SERVICES

You should exercise the utmost care to prevent damage to your vehicle and injury to yourself whenever performing any maintenance or inspection procedures.

Inadequate, incomplete or insufficient servicing may result in operational problems with your vehicle that could lead to vehicle damage, an accident, or personal injury.

### Owner's responsibility

#### \* NOTICE

**Maintenance Service and Record Retention are the owner's responsibility.**

We recommend in general that you have your vehicle serviced by an authorized HYUNDAI dealer.

You should retain documents that show proper maintenance has been performed on your vehicle in accordance with the scheduled maintenance service charts shown on the following pages. You need this information to establish your compliance with the servicing and maintenance requirements of your vehicle warranties.

Repairs and adjustments required as a result of improper maintenance or a lack of required maintenance are not covered when your vehicle is covered by warranty.

### Owner maintenance precautions

Improper or incomplete service may result in problems. This section gives instructions only for the maintenance items that are easy to perform.

#### \* NOTICE

**Improper owner maintenance during the warranty period may affect warranty coverage. For details, read the separate Service Passport provided with the vehicle. If you're unsure about any servicing or maintenance procedure, we recommend that the system be serviced by an authorized HYUNDAI dealer.**

**⚠ WARNING -**

**Maintenance work**

- Performing maintenance work on a vehicle can be dangerous. You can be seriously injured while performing some maintenance procedures. If you lack sufficient knowledge and experience or the proper tools and equipment to do the work, we recommend that the system be serviced by an authorized HYUNDAI dealer.
- Working under the hood with the engine running is dangerous. It becomes even more dangerous when you wear jewelry or loose clothing.

(Continued)

(Continued)

These can become entangled in moving parts and result in injury. Therefore, if you must run the engine while working under the hood, make certain that you remove all jewelry (especially rings, bracelets, watches, and necklaces) and all neckties, scarves, and similar loose clothing before getting near the engine or cooling fans.

تلفن شبانه روزی: ۰۲۱-۸۸۸۶۲۰۸۵

FarmaSOS.com

**⚠ CAUTION**

- *Do not put heavy objects or apply excessive force on top of the engine cover (if equipped) or fuel related parts.*
- *When you inspect the fuel system (fuel lines and fuel injection devices), we recommend that you contact an authorized HYUNDAI dealer.*
- *Do not drive long time with the engine cover (if equipped) removed.*
- *When checking the engine room, do not go near fire. Fuel, washer fluid, etc. are flammable oils that may cause fire.*
- *Before touching the battery, ignition cables and electrical wiring, you should disconnect the battery "-" terminal. You may get an electric shock from the electric current.*

(Continued)

*(Continued)*

- *When you remove the interior trim cover with a flat head (-) driver, be careful not to damage the cover.*
- *Be careful when you replace and clean bulbs to avoid burns or electrical shock.*

### Engine compartment precautions (Diesel engine)

- The piezo injector operates at high voltage (maximum 200v). Therefore, the following accidents may occur.
  - Direct contact with the injector or injector wiring may cause electric shock or damage your muscle or nerve system.
  - The electromagnetic wave from the operating injector may cause the artificial heart pacemaker to malfunction.
- Follow the safety tips provided below, when you are checking the engine room while the engine is running.
  - Do not touch the injector, injector wirings, and the engine computer while the engine is running.
  - Do not remove the injector connector while the engine is running.
  - People using pacemakers must not go near the engine while the engine is starting or running.

**⚠ WARNING - Diesel Engine**  
**Never work on injection system with engine running or within 30 seconds after shutting off engine. High-pressure pump, rail, injectors and high-pressure pipes are subject to high pressure even after the engine stopped. The fuel jet produced by fuel leaks may cause serious injury, if it touches the body. People using pacemakers should not move than 30cm closer to the ECU or wiring harness within the engine room while engine is running, since the high currents in the electronic engine control system produce considerable magnetic fields.**



## OWNER MAINTENANCE

The following lists are vehicle checks and inspections that should be performed at the frequencies indicated to help ensure safe, dependable operation of your vehicle.

If you have any question, we recommend that you consult an authorized HYUNDAI dealer.

These Owner Maintenance Checks are generally not covered by warranties and you may be charged for labor, parts and lubricants used.

### Owner maintenance schedule

#### *When you stop for fuel:*

- Check the engine oil level.
- Check coolant level in coolant reservoir.
- Check the windshield washer fluid level.
- Look for low or under-inflated tires.

#### **⚠ WARNING**

**Be careful when checking your engine coolant level when the engine is hot. Scalding hot coolant and steam may blow out under pressure. This could cause burns or other serious injury.**

#### *While operating your vehicle:*

- Note any changes in the sound of the exhaust or any smell of exhaust fumes in the vehicle.
- Check for vibrations in the steering wheel. Notice any increased steering effort or looseness in the steering wheel, or change in its straight-ahead position.
- Notice if your vehicle constantly turns slightly or “pulls” to one side when traveling on smooth, level road.
- When stopping, listen and check for unusual sounds, pulling to one side, increased brake pedal travel or “hard-to-push” brake pedal.
- If any slipping or changes in the operation of your transaxle occurs, check the transaxle fluid level.
- Check manual transaxle operation, including clutch operation.
- Check automatic transaxle P (Park) function.

- Check parking brake.
- Check for fluid leaks under your vehicle (water dripping from the air conditioning system during or after use is normal).

***At least monthly:***

- Check coolant level in the engine coolant reservoir.
- Check the operation of all exterior lights, including the stoplights, turn signals and hazard warning flashers.
- Check the inflation pressures of all tires including the spare.

***At least twice a year  
(i.e., every Spring and Fall) :***

- Check radiator, heater and air conditioning hoses for leaks or damage.
- Check windshield washer spray and wiper operation. Clean wiper blades with clean cloth dampened with washer fluid.
- Check headlight alignment.
- Check muffler, exhaust pipes, shields and clamps.
- Check the lap/shoulder belts for wear and function.
- Check for worn tires and loose wheel lug nuts.

***At least once a year :***

- Clean body and door drain holes.
- Lubricate door hinges and checks, and hood hinges.
- Lubricate door and hood locks and latches.
- Lubricate door rubber weatherstrips.
- Check the air conditioning system.
- Check the power steering fluid level.
- Inspect and lubricate automatic transaxle linkage and controls.
- Clean battery and terminals.
- Check the brake (and clutch) fluid level.

FarmaSOS.com

### SCHEDULED MAINTENANCE SERVICE

Follow Normal Maintenance Schedule if the vehicle is usually operated where none of the following conditions apply. If any of the following conditions apply, follow Maintenance Under Severe Usage Conditions.

- Repeated short distance driving.
- Driving in dusty conditions or sandy areas.
- Extensive use of brakes.
- Driving in areas where salt or other corrosive materials are being used.
- Driving on rough or muddy roads.
- Driving in mountainous areas.
- Extended periods of idling or low speed operation.
- Driving for a prolonged period in cold temperatures and/or extremely humid climates.
- More than 50% driving in heavy city traffic during hot weather above 32°C (90°F).

*If your vehicle is operated under the above conditions, you should inspect, replace or refill more frequently than the following Normal Maintenance Schedule. After the periods or distance shown in the chart, continue to follow the prescribed maintenance intervals.*

امداد خودرو فارما

تلفن شبانه روزی: ۰۲۱-۸۸۸۶۲۰۸۵

FarmaSOS.com

## NORMAL MAINTENANCE SCHEDULE - FOR EUROPE, EXCEPT RUSSIA

The following maintenance services must be performed to ensure good emission control and performance. Keep receipts for all vehicle emission services to protect your warranty. Where both mileage and time are shown, the frequency of service is determined by whichever occurs first.

- \*1 : Check the engine oil level and leak every 500 km (350 miles) or before starting a long trip.
- \*2 : This maintenance schedule depends on fuel quality. It is applicable only when using a qualified fuel <"EN590 or equivalent">. If the diesel fuel specifications don't meet the EN590, it must be replaced according to the severe maintenance schedule.
- \*3 : If the recommended oil is not available, replace engine oil and engine oil filter every 20,000 km or 12 months.
- \*4 : If the recommended oil is not available, replace engine oil and filter every 15,000 km or 12 months for 2.4L engine.
- \*5 : The engine oil level should be checked regularly and maintained properly. Operating with an insufficient amount of oil can damage the engine, and such damage is not covered by warranty.
- \*6 : This maintenance schedule depends on fuel quality. It is applicable only when using a qualified fuel <"EN590 or equivalent">. If the diesel fuel specifications don't meet the EN590, it must be replaced more frequently. If there are some important safety matters like fuel flow restriction, surging, loss of power, hard starting problem etc., replace the fuel filter immediately regardless of maintenance schedule and we recommended that you consult an authorized HYUNDAI dealer for details.
- \*7 : The fuel filter is considered to be maintenance free but periodic inspection is recommended for this maintenance schedule depends on fuel quality. If there are some important matters like fuel flow restriction, surging, loss of power, hard starting problem etc, replace the fuel filter immediately regardless of maintenance schedule and we recommended that you consult an authorized HYUNDAI dealer for details.
- \*8 : Manual transaxle fluid, transfer case oil and differential oil should be changed anytime they have been submerged in water.
- \*9 : Inspect and if necessary correct or replace. Inspect drive belt tensioner, idler and alternator pulley and if necessary correct or replace.
- \*10 : When adding coolant, use only deionized water or soft water for your vehicle and never mix hard water in the coolant filled at the factory. An improper coolant mixture can result in serious malfunction or engine damage.
- \*11 : Inspect for excessive valve noise and/or engine vibration and adjust if necessary. We recommended that the system should be checked by an authorized HYUNDAI dealer.
- \*12 : If good quality gasolines that meet Europe Fuel standards (EN228) or equivalents including fuel additives is not available, one bottle of additive is recommended. Additives are available from your authorized HYUNDAI dealer along with information on how to use them. Do not mix other additives.

## NORMAL MAINTENANCE SCHEDULE - FOR EUROPE, EXCEPT RUSSIA (CONT.)

### 30,000 km (20,000 miles) or 24 months

- Inspect air cleaner filter
- Inspect air conditioner refrigerant/compressor (if equipped)
- Inspect battery condition
- Inspect brake lines, hoses and connections
- Inspect all electrical system
- Inspect disc brakes and pads
- Inspect drive shafts and boots
- Inspect exhaust system
- Inspect front suspension ball joints
- Inspect fuel filter cartridge (Diesel) \*6
- Inspect fuel lines, fuel hoses and connections (Diesel)
- Inspect parking brake (Foot/Hand type)
- Inspect power steering fluid and hoses (if equipped)
- Inspect propeller shaft (if equipped)
- Inspect steering gear rack, linkage and boots
- Inspect tire (pressure & tread wear)
- Inspect vacuum hose (for EGR & throttle body)  
(Gasoline)
- Replace brake/clutch(if equipped) fluid
- Replace climate control air filter
- Replace engine oil and filter (Diesel - R) \*1 \*2 \*3\*5

(Continued)

(Continued)

- Replace engine oil and filter (Gasoline - theta) \*1 \*4 \*5
- Add fuel additives (Gasoline) \*12  
(Every 15,000 km or 12months)

※ Inspect : Inspect and if necessary, adjust, correct, clean or replace.

امداد خودرو فارما

تلفن شبانه روزی: ۰۲۱-۸۸۸۶۲۰۸۵

FarmaSOS.com

**NORMAL MAINTENANCE SCHEDULE - FOR EUROPE, EXCEPT RUSSIA (CONT.)****60,000 km (40,000 miles) or 48 months**

- Inspect air conditioner refrigerant/compressor (if equipped)
- Inspect battery condition
- Inspect brake lines, hoses and connections
- Inspect all electrical system
- Inspect disc brakes and pads
- Inspect drive shafts and boots
- Inspect exhaust system
- Inspect front suspension ball joints
- Inspect fuel filter (Gasoline) \*7
- Inspect fuel tank air filter (Gasoline, if equipped)
- Inspect fuel lines, fuel hoses and connections (Gasoline, Diesel)
- Inspect manual transaxle fluid (if equipped) \*8
- Inspect parking brake (Foot/Hand type)
- Inspect power steering fluid and hoses (if equipped)
- Inspect propeller shaft (if equipped)
- Inspect steering gear rack, linkage and boots
- Inspect tire (pressure & tread wear)
- Inspect transfer case oil (4WD) \*8
- Inspect rear differential oil (4WD) \*8
- Inspect vacuum hose (for EGR & throttle body) (Gasoline)

(Continued)

(Continued)

- Inspect vapor hose and fuel filler cap
- Replace air cleaner filter
- Replace brake/clutch(if equipped) fluid
- Replace climate control air filter
- Replace engine oil and filter (Diesel - R) \*1 \*2 \*3\*5
- Replace engine oil and filter (Gasoline - theta) \*1 \*4 \*5
- Replace fuel filter cartridge (Diesel) \*6
- Inspect cooling system  
(At first, 60,000 km (40,000 miles) or 48months  
after that, every 30,000 km (20,000 miles) or 24months)
- Add fuel additives (Gasoline) \*12  
(Every 15,000 km or 12months)

\* Inspect : Inspect and if necessary, adjust, correct, clean or replace.

**NORMAL MAINTENANCE SCHEDULE - FOR EUROPE, EXCEPT RUSSIA (CONT.)**

**90,000 km (60,000 miles) or 72 months**

- Inspect air cleaner filter
- Inspect air conditioner refrigerant/compressor (if equipped)
- Inspect battery condition
- Inspect brake lines, hoses and connections
- Inspect all electrical system
- Inspect disc brakes and pads
- Inspect drive shafts and boots
- Inspect exhaust system
- Inspect front suspension ball joints
- Inspect fuel filter cartridge (Diesel) \*6
- Inspect fuel lines, fuel hoses and connections (Diesel)
- Inspect parking brake (Foot/Hand type)
- Inspect power steering fluid and hoses (if equipped)
- Inspect propeller shaft (if equipped)
- Inspect steering gear rack, linkage and boots
- Inspect tire (pressure & tread wear)
- Inspect vacuum hose (for EGR & throttle body) (Gasoline)
- Inspect valve clearance (Gasoline) \*11
- Replace brake/clutch(if equipped) fluid
- Replace climate control air filter
- Replace engine oil and filter (Diesel - R) \*1 \*2 \*3\*5

(Continued)

(Continued)

- Replace engine oil and filter (Gasoline - theta) \*1 \*4 \*5
- Inspect cooling system  
(At first, 60,000 km (40,000 miles) or 48months  
after that, every 30,000 km (20,000 miles) or 24months)
- Inspect drive belt (Diesel) \*9  
(At first, 90,000 km (60,000 miles) or 48months  
after that, every 30,000 km (20,000 miles) or 24months)
- Inspect drive belt (Gasoline) \*9  
(At first, 90,000 km (60,000 miles) or 72months  
after that, every 30,000 km (20,000 miles) or 24months )
- Add fuel additives (Gasoline) \*12  
(Every 15,000 km or 12months)

\* Inspect : Inspect and if necessary, adjust, correct, clean or replace.

**NORMAL MAINTENANCE SCHEDULE - FOR EUROPE, EXCEPT RUSSIA (CONT.)****120,000 km (80,000 miles) or 96 months**

- Inspect air conditioner refrigerant/compressor (if equipped)
- Inspect battery condition
- Inspect brake lines, hoses and connections
- Inspect all electrical system
- Inspect disc brakes and pads
- Inspect drive shafts and boots
- Inspect exhaust system
- Inspect front suspension ball joints
- Inspect fuel filter (Gasoline) \*7
- Inspect fuel tank air filter (Gasoline, if equipped)
- Inspect fuel lines, fuel hoses and connections (Gasoline, Diesel)
- Inspect manual transaxle fluid (if equipped) \*8
- Inspect parking brake (Foot/Hand type)
- Inspect power steering fluid and hoses (if equipped)
- Inspect propeller shaft (if equipped)
- Inspect steering gear rack, linkage and boots
- Inspect transfer case oil (4WD) \*8
- Inspect rear differential oil (4WD) \*8
- Inspect vacuum hose (for EGR & throttle body) (Gasoline)
- Inspect tire (pressure & tread wear)

(Continued)

(Continued)

- Inspect vapor hose and fuel filler cap
- Replace air cleaner filter
- Replace brake/clutch (if equipped) fluid
- Replace climate control air filter
- Replace engine oil and filter (Diesel - R) \*1 \*2 \*3\*5
- Replace engine oil and filter (Gasoline - theta) \*1 \*4 \*5
- Replace fuel filter cartridge (Diesel) \*6
- Inspect cooling system  
(At first, 60,000 km (40,000 miles) or 48months  
after that, every 30,000 km (20,000 miles) or 24months)
- Inspect drive belt (Diesel) \*9  
(At first, 90,000 km (60,000 miles) or 48months  
after that, every 30,000 km (20,000 miles) or 24months)
- Inspect drive belt (Gasoline) \*9  
(At first, 90,000 km (60,000 miles) or 72months  
after that, every 30,000 km (20,000 miles) or 24months )
- Add fuel additives (Gasoline) \*12  
(Every 15,000 km or 12months)

\* Inspect : Inspect and if necessary, adjust, correct, clean or replace.



## NORMAL MAINTENANCE SCHEDULE - FOR EUROPE, EXCEPT RUSSIA (CONT.)

### 150,000 km (100,000 miles) or 120 months

- Inspect air cleaner filter
- Inspect air conditioner refrigerant/compressor (if equipped)
- Inspect battery condition
- Inspect brake lines, hoses and connections
- Inspect all electrical system
- Inspect disc brakes and pads
- Inspect drive shafts and boots
- Inspect exhaust system
- Inspect front suspension ball joints
- Inspect fuel filter cartridge (Diesel) \*6
- Inspect fuel lines, fuel hoses and connections (Diesel)
- Inspect parking brake (Foot/Hand type)
- Inspect power steering fluid and hoses (if equipped)
- Inspect propeller shaft (if equipped)
- Inspect steering gear rack, linkage and boots
- Inspect tire (pressure & tread wear)
- Inspect vacuum hose (for EGR & throttle body) (Gasoline)
- Replace brake/clutch(if equipped) fluid
- Replace climate control air filter
- Replace engine oil and filter (Diesel - R) \*1 \*2 \*3\*5
- Replace engine oil and filter (Gasoline - theta) \*1 \*4 \*5

(Continued)

(Continued)

- Inspect cooling system  
(At first, 60,000 km (40,000 miles) or 48 months after that, every 30,000 km (20,000 miles) or 24 months)
- Inspect drive belt (Diesel) \*9  
(At first, 90,000 km (60,000 miles) or 48months after that, every 30,000 km (20,000 miles) or 24 months)
- Inspect drive belt (Gasoline) \*9  
(At first, 90,000 km (60,000 miles) or 72months after that, every 30,000 km (20,000 miles) or 24 months )
- Add fuel additives (Gasoline) \*12  
(Every 15,000 km or 12months)
- Replace spark plug (Gasoline 2.4/3.3L - Iridium)  
(Every 160,000 km (100,000 miles) or 120 months)

\* Inspect : Inspect and if necessary, adjust, correct, clean or replace.

## NORMAL MAINTENANCE SCHEDULE - FOR EUROPE, EXCEPT RUSSIA (CONT.)

### 180,000 km (120,000 miles) or 144 months

- Inspect air conditioner refrigerant/compressor (if equipped)
- Inspect all electrical system
- Inspect battery condition
- Inspect brake lines, hoses and connections
- Inspect disc brakes and pads
- Inspect drive shafts and boots
- Inspect exhaust system
- Inspect front suspension ball joints
- Inspect fuel filter (Gasoline) \*7
- Inspect fuel tank air filter (Gasoline, if equipped)
- Inspect fuel lines, fuel hoses and connections (Gasoline, Diesel)
- Inspect manual transaxle fluid (if equipped) \*8
- Inspect parking brake (Foot/Hand type)
- Inspect power steering fluid and hoses (if equipped)
- Inspect propeller shaft (if equipped)
- Inspect steering gear rack, linkage and boots
- Inspect transfer case oil (4WD) \*8
- Inspect rear differential oil (4WD) \*8
- Inspect tire (pressure & tread wear)
- Inspect vacuum hose (for EGR & throttle body) (Gasoline)

(Continued)

(Continued)

- Inspect valve clearance (Gasoline) \*11
- Inspect vapor hose and fuel filler cap
- Replace air cleaner filter
- Replace brake/clutch(if equipped) fluid
- Replace climate control air filter
- Replace engine oil and filter (Diesel - R) \*1 \*2 \*3\*5
- Replace engine oil and filter (Gasoline - theta) \*1 \*4 \*5
- Replace fuel filter cartridge (Diesel) \*6
- Inspect cooling system  
(At first, 60,000 km (40,000 miles) or 48months  
after that, every 30,000 km (20,000 miles) or 24months)
- Inspect drive belt (Diesel) \*9  
(At first, 90,000 km (60,000 miles) or 48months  
after that, every 30,000 km (20,000 miles) or 24months)
- Inspect drive belt (Gasoline) \*9  
(At first, 90,000 km (60,000 miles) or 72months  
after that, every 30,000 km (20,000 miles) or 24months )
- Add fuel additives (Gasoline) \*12  
(Every 15,000 km or 12months)

\* Inspect : Inspect and if necessary, adjust, correct, clean or replace.

## NORMAL MAINTENANCE SCHEDULE - FOR EUROPE, EXCEPT RUSSIA (CONT.)

### 210,000 km (140,000 miles) or 168 months

- Inspect air cleaner filter
- Inspect air conditioner refrigerant/compressor (if equipped)
- Inspect battery condition
- Inspect brake lines, hoses and connections
- Inspect all electrical system
- Inspect disc brakes and pads
- Inspect drive shafts and boots
- Inspect exhaust system
- Inspect front suspension ball joints
- Inspect fuel lines, fuel hoses and connections (Diesel)
- Inspect parking brake (Foot/Hand type)
- Inspect power steering fluid and hoses (if equipped)
- Inspect steering gear rack, linkage and boots
- Inspect tire (pressure & tread wear)
- Inspect fuel filter cartridge (Diesel) \*<sup>6</sup>
- Inspect propeller shaft (if equipped)
- Inspect vacuum hose (for EGR & throttle body) (Gasoline)
- Inspect cooling system  
(At first, 60,000 km (40,000 miles) or 48months  
after that, every 30,000 km (20,000 miles) or 24months)

(Continued)

(Continued)

- Inspect drive belt (Diesel) \*<sup>9</sup>  
(At first, 90,000 km (60,000 miles) or 48months  
after that, every 30,000 km (20,000 miles) or 24months)
- Inspect drive belt (Gasoline)\*<sup>9</sup>  
(At first, 90,000 km (60,000 miles) or 72months  
after that, every 30,000 km (20,000 miles) or 24months )
- Replace brake/clutch(if equipped) fluid
- Replace climate control air filter
- Replace engine oil and filter (Diesel - R) \*<sup>1</sup> \*<sup>2</sup> \*<sup>3</sup>\*<sup>5</sup>
- Replace engine oil and filter (Gasoline - theta) \*<sup>1</sup> \*<sup>4</sup> \*<sup>5</sup>
- Replace coolant \*<sup>10</sup>  
(At first, 210,000 km (120,000 miles) or 120 months  
after that, every 30,000 km (20,000 miles) or 24months)
- Add fuel additives (Gasoline) \*<sup>12</sup>  
(Every 15,000 km or 12months)

\* Inspect : Inspect and if necessary, adjust, correct, clean or replace.

**NORMAL MAINTENANCE SCHEDULE - FOR EUROPE, EXCEPT RUSSIA (CONT.)****240,000 km (160,000 miles) or 192 months**

- Inspect air conditioner refrigerant/compressor (if equipped)
- Inspect battery condition
- Inspect brake lines, hoses and connections
- Inspect all electrical system
- Inspect disc brakes and pads
- Inspect drive shafts and boots
- Inspect exhaust system
- Inspect front suspension ball joints
- Inspect fuel filter (Gasoline) \*7
- Inspect fuel tank air filter (Gasoline, if equipped)
- Inspect fuel lines, fuel hoses and connections (Gasoline, Diesel)
- Inspect manual transaxle fluid (if equipped) \*8
- Inspect parking brake (Foot/Hand type)
- Inspect power steering fluid and hoses (if equipped)
- Inspect steering gear rack, linkage and boots
- Inspect transfer case oil (4WD) \*8
- Inspect rear differential oil (4WD) \*8
- Inspect propeller shaft (if equipped)
- Inspect vacuum hose (for EGR & throttle body) (Gasoline)
- Inspect tire (pressure & tread wear)
- Inspect vapor hose and fuel filler cap

(Continued)

(Continued)

- Replace air cleaner filter
- Replace brake/clutch(if equipped) fluid
- Replace climate control air filter
- Replace engine oil and filter (Diesel - R) \*1 \*2 \*3\*5
- Replace engine oil and filter (Gasoline - theta) \*1 \*4 \*5
- Replace fuel filter cartridge (Diesel) \*6
- Inspect cooling system  
(At first, 60,000 km (40,000 miles) or 48months  
after that, every 30,000 km (20,000 miles) or 24months)
- Inspect drive belt (Diesel) \*9  
(At first, 90,000 km (60,000 miles) or 48months  
after that, every 30,000 km (20,000 miles) or 24months)
- Inspect drive belt (Gasoline) \*9  
(At first, 90,000 km (60,000 miles) or 72months  
after that, every 30,000 km (20,000 miles) or 24months )
- Add fuel additives (Gasoline) \*12  
(Every 15,000 km or 12months)

**No check, No service required**

- Automatic transaxle fluid

\* Inspect : Inspect and if necessary, adjust, correct, clean or replace.

## MAINTENANCE UNDER SEVERE USAGE CONDITIONS - FOR EUROPE, EXCEPT RUSSIA

The following items must be serviced more frequently on cars mainly used under severe driving conditions.

Refer to the chart below for the appropriate maintenance intervals.

R : Replace I : Inspect and if necessary, adjust, correct, clean or replace

MAINTENANCE ITEM		MAINTENANCE OPERATION	MAINTENANCE INTERVALS	DRIVING CONDITION
Engine oil and engine oil filter	Gasoline *1	R	Every 15,000 km (10,000 miles) or 12 months	A, B, C, D, E, F, G, H, I, J, K, L
	Diesel *2	R	Every 15,000 km (10,000 miles) or 12 months	A, B, C, F, G, H, I, J, K, L
Air cleaner filter		R	Replace more frequently depending on the condition	C, E
Manual transaxle fluid (if equipped)		R	Every 120,000 km (80,000 miles)	C, E, F, G, I, K
Automatic transaxle fluid (if equipped)		R	Every 90,000 km (60,000 miles)	A, C, D, E, F, G, H, I, K
Steering gear rack, linkage and boots		I	Inspect more frequently depending on the condition	C, D, E, F, G
Front suspension ball joints		I	Inspect more frequently depending on the condition	C, D, E, F, G
Disc brakes and pads, calipers and rotors		I	Inspect more frequently depending on the condition	C, D, E, G, H

\*1 : If the recommended oil is not available, replace engine oil and engine oil filter every 7,500 km.

\*2 : If the recommended oil is not available, replace engine oil and engine oil filter every 10,000 km or 6 months.

MAINTENANCE ITEM	MAINTENANCE OPERATION	MAINTENANCE INTERVALS	DRIVING CONDITION
Propeller shaft (if equipped)	I	Every 15,000 km (10,000 miles) or 12 months	C, E
Rear differential oil (4WD)	R	Every 120,000 km (80,000 miles)	C, D, E, G, H, I, K
Transfer case oil (4WD)	R	Every 120,000 km (80,000 miles)	C, D, E, G, H, I, K
Parking brake (Foot/Hand type)	I	Inspect more frequently depending on the condition	C, D, G, H
Drive shaft and boots	I	Inspect more frequently depending on the condition	C, D, E, F, G, H, I, J, K
Climate control air filter	R	Replace more frequently depending on the condition	C, E, G

### SEVERE DRIVING CONDITIONS

- A : Repeated short distance driving
- B : Extensive idling
- C : Driving in dusty, rough roads
- D : Driving in areas using salt or other corrosive materials or in very cold weather
- E : Driving in sandy areas
- F : More than 50 % driving in heavy city traffic during hot weather above 32 °C (90 °F)

- G : Driving in mountainous areas.
- H : Towing a trailer or using a camper on roof rack
- I : Driving for patrol car, taxi, commercial car or vehicle towing
- J : Driving in very cold weather
- K : Driving over 170 km/h (106 mile/h)
- L : Frequently driving in stop-and-go conditions

### **NORMAL MAINTENANCE SCHEDULE - EXCEPT EUROPE, FOR RUSSIA**

The following maintenance services must be performed to ensure good emission control and performance. Keep receipts for all vehicle emission services to protect your warranty. Where both mileage and time are shown, the frequency of service is determined by whichever occurs first.

- \*1 : Inspect drive belt tensioner, idler and alternator pulley and if necessary correct or replace.
- \*2 : Check the engine oil level and leak every 500 km (350 miles) or before starting a long trip.
- \*3 : The engine oil level should be checked regularly and maintained properly. Operating with an insufficient amount of oil can damage the engine, and such damage is not covered by warranty.
- \*4 : This maintenance schedule depends on fuel quality. It is applicable only when using a qualified fuel <"EN590 or equivalent">. If the diesel fuel specifications don't meet the EN590, it must be replaced more frequently. HYUNDAI recommends "every 7,500km inspection, every 15,000km replacement". If there are some important safety matters like fuel flow restriction, surging, loss of power, hard starting problem etc., replace the fuel filter immediately regardless of maintenance schedule and we recommend that you consult an authorized HYUNDAI dealer for details
- \*5 : For your convenience, it can be replaced prior to it's interval when you do maintenance of other items.
- \*6 : Inspect for excessive valve noise and/or engine vibration and adjust if necessary. We recommended that the system should be checked by an authorized HYUNDAI dealer.
- \*7 : The fuel filter is considered to be maintenance free but periodic inspection is recommended for this maintenance schedule depends on fuel quality. If there are some important matters like fuel flow restriction, surging, loss of power, hard starting problem etc, replace the fuel filter immediately regardless of maintenance schedule and we recommend that you consult an authorized HYUNDAI dealer for details.
- \*8 : When adding coolant, use only deionized water or soft water for your vehicle and never mix hard water in the coolant filled at the factory. An improper coolant mixture can result in serious malfunction or engine damage.
- \*9 : Inspect and if necessary correct or replace. Inspect drive belt tensioner, idler and alternator pulley and if necessary correct or replace.
- \*10 : If good quality gasolines that meet Europe Fuel standards (EN228) or equivalents including fuel additives is not available, one bottle of additive is recommended. Additives are available from your authorized HYUNDAI dealer along with information on how to use them. Do not mix other additives.
- \*11 : Manual transaxle fluid, transfer case oil and differential oil should be changed anytime they have been submerged in water.

**NORMAL MAINTENANCE SCHEDULE - EXCEPT EUROPE, FOR RUSSIA (CONT.)****15,000 km (10,000 miles) or 12months**

- Inspect air cleaner filter  
(for Except China, India, Middle East)
- Inspect air conditioner refrigerant/compressor (if equipped)
- Inspect battery condition
- Inspect brake lines, hoses and connections
- Inspect brake/clutch (if equipped) fluid
- Inspect disc brakes and pads
- Inspect front suspension ball joints
- Inspect steering gear rack, linkage and boots
- Inspect tire (pressure & tread wear)
- Inspect power steering fluid and hoses (if equipped)
- Inspect vacuum hose (for EGR & throttle body) (Gasoline)
- Replace air cleaner filter (for China, India, Middle East)
- Replace climate control air filter
- Replace engine oil and filter (Gasoline - MPI)  
- Except Middle East \*2
- Replace engine oil and filter (Gasoline - MPI)  
- For Middle East \*2  
(Every 10,000 km (6,500 miles) or 12months\*3)
- Replace engine oil and filter (Gasoline - GDI) \*2  
- For China  
(Every 5,000 km (3,100 miles) or 6months)

(Continued)

(Continued)

- Replace engine oil and filter (Diesel) - For Russia \*2 \*3
- Replace engine oil and filter (Diesel) - Except Russia \*2 \*3  
(Every 10,000 km (6,500 miles) or 12months)
- Add fuel additives (Gasoline) \*10  
(Every 5,000 km or 6months)

\* Inspect : Inspect and if necessary, adjust, correct, clean or replace.



## NORMAL MAINTENANCE SCHEDULE - EXCEPT EUROPE, FOR RUSSIA (CONT.)

### 30,000 km (20,000 miles) or 24months

- Inspect air cleaner filter  
(for Except China, India, Middle East)
- Inspect air conditioner refrigerant/compressor (if equipped)
- Inspect battery condition
- Inspect brake lines, hoses and connections
- Inspect all electrical system
- Inspect brake/clutch(if equipped) fluid
- Inspect disc brakes and pads
- Inspect drive belt (Gasoline) \*<sup>1</sup>
- Inspect drive shafts and boots
- Inspect exhaust system
- Inspect front suspension ball joints
- Inspect fuel filter (Gasoline) \*<sup>7</sup>
- Inspect fuel tank air filter (Gasoline, if equipped)
- Inspect fuel filter cartridge (Diesel) \*<sup>4</sup>
- Inspect fuel lines, hoses and connections (Diesel)
- Inspect parking brake (Foot/Hand type)
- Inspect power steering fluid and hoses (if equipped)
- Inspect propeller shaft (if equipped)
- Inspect steering gear rack, linkage and boots
- Inspect tire (pressure & tread wear)

(Continued)

(Continued)

- Inspect vacuum hose (for EGR & throttle body) (Gasoline)
- Replace air cleaner filter (for China, India, Middle East)
- Replace climate control air filter
- Replace engine oil and filter (Gasoline - MPI)  
- Except Middle East \*<sup>2</sup>
- Replace engine oil and filter (Gasoline - MPI)  
- For Middle East \*<sup>2</sup>  
(Every 10,000 km (6,500 miles) or 12months\*<sup>3</sup>)
- Replace engine oil and filter (Gasoline - GDI) \*<sup>2</sup>  
- For China  
(Every 5,000 km (3,100 miles) or 6months)
- Replace engine oil and filter (Diesel) - For Russia \*<sup>2</sup> \*<sup>3</sup>
- Replace engine oil and filter (Diesel) - Except Russia \*<sup>2</sup> \*<sup>3</sup>  
(Every 10,000 km (6,500 miles) or 12months)
- Add fuel additives (Gasoline) \*<sup>10</sup>  
(Every 5,000 km or 6months)

\* Inspect : Inspect and if necessary, adjust, correct, clean or replace.

**NORMAL MAINTENANCE SCHEDULE - EXCEPT EUROPE, FOR RUSSIA (CONT.)****45,000 km (30,000 miles) or 36months**

- Inspect air conditioner refrigerant/compressor (if equipped)
- Inspect battery condition
- Inspect brake lines, hoses and connections
- Inspect brake/clutch(if equipped) fluid
- Inspect disc brakes and pads
- Inspect front suspension ball joints
- Inspect power steering fluid and hoses (if equipped)
- Inspect steering gear rack, linkage and boots
- Inspect tire (pressure & tread wear)
- Inspect vacuum hose (for EGR & throttle body) (Gasoline)
- Replace air cleaner filter (for all region)
- Replace climate control air filter
- Replace engine oil and filter (Gasoline - MPI)
  - Except Middle East \*2
- Replace engine oil and filter (Gasoline - MPI)
  - For Middle East \*2
  - (Every 10,000 km (6,500 miles) or 12months\*3)
- Replace engine oil and filter (Gasoline - GDI) \*2
  - For China
  - (Every 5,000 km (3,100 miles) or 6months)
- Replace engine oil and filter (Diesel) - For Russia \*2 \*3

(Continued)

(Continued)

- Replace engine oil and filter (Diesel) - Except Russia \*2 \*3
  - (Every 10,000 km (6,500 miles) or 12months)
- Add fuel additives (Gasoline) \*10
  - (Every 5,000 km or 6months)

\* Inspect : Inspect and if necessary, adjust, correct, clean or replace.

تلفن شبانه روزی: ۰۲۱-۸۸۶۲۰۸۵

FarmaSOS.com

**NORMAL MAINTENANCE SCHEDULE - EXCEPT EUROPE, FOR RUSSIA (CONT.)**

60,000 km (40,000 miles) or 48months
<ul style="list-style-type: none"> <li><input type="checkbox"/> Inspect air cleaner filter (for Except China, India, Middle East)</li> <li><input type="checkbox"/> Inspect air conditioner refrigerant/compressor (if equipped)</li> <li><input type="checkbox"/> Inspect battery condition</li> <li><input type="checkbox"/> Inspect brake lines, hoses and connections</li> <li><input type="checkbox"/> Inspect all electrical systems</li> <li><input type="checkbox"/> Inspect brake/clutch (if equipped) fluid</li> <li><input type="checkbox"/> Inspect disc brakes and pads</li> <li><input type="checkbox"/> Inspect drive belt (Gasoline) *1</li> <li><input type="checkbox"/> Inspect drive shafts and boots</li> <li><input type="checkbox"/> Inspect exhaust system</li> <li><input type="checkbox"/> Inspect front suspension ball joints</li> <li><input type="checkbox"/> Inspect fuel lines, hoses and connections (Gasoline, Diesel)</li> <li><input type="checkbox"/> Inspect manual transaxle fluid (if equipped) *11</li> <li><input type="checkbox"/> Inspect parking brake (Foot/Hand type)</li> <li><input type="checkbox"/> Inspect power steering fluid and hoses (if equipped)</li> <li><input type="checkbox"/> Inspect steering gear rack, linkage and boots</li> <li><input type="checkbox"/> Inspect tire (pressure &amp; tread wear)</li> <li><input type="checkbox"/> Inspect vacuum hose (for EGR &amp; throttle body) (Gasoline)</li> <li><input type="checkbox"/> Inspect transfer case oil (4WD) *11</li> <li><input type="checkbox"/> Inspect rear differential oil (4WD) *11</li> </ul>
(Continued)

<p>(Continued)</p> <ul style="list-style-type: none"> <li><input type="checkbox"/> Inspect vapor hose and fuel filler cap (Gasoline)</li> <li><input type="checkbox"/> Replace air cleaner filter (for China, India, Middle East)</li> <li><input type="checkbox"/> Replace fuel tank air filter (Gasoline, if equipped)</li> <li><input type="checkbox"/> Replace climate control air filter</li> <li><input type="checkbox"/> Replace engine oil and filter (Gasoline - MPI) - Except Middle East *2</li> <li><input type="checkbox"/> Replace engine oil and filter (Gasoline - MPI) - For Middle East *2 (Every 10,000 km (6,500 miles) or 12months*3)</li> <li><input type="checkbox"/> Replace engine oil and filter (Gasoline - GDI) *2 - For China (Every 5,000 km (3,100 miles) or 6months)</li> <li><input type="checkbox"/> Replace engine oil and filter (Diesel) - For Russia *2 *3</li> <li><input type="checkbox"/> Replace engine oil and filter (Diesel) - Except Russia *2 *3 (Every 10,000 km (6,500 miles) or 12months)</li> <li><input type="checkbox"/> Replace fuel filter (Gasoline) *7</li> <li><input type="checkbox"/> Replace fuel filter cartridge (Diesel) *4</li> <li><input type="checkbox"/> Inspect cooling system (At first, 60,000 km (40,000 miles) or 48months after that, every 30,000 km (20,000 miles) or 24months)</li> <li><input type="checkbox"/> Add fuel additives (Gasoline) *10 (Every 5,000 km or 6months)</li> </ul>
---

\* Inspect : Inspect and if necessary, adjust, correct, clean or replace.

**NORMAL MAINTENANCE SCHEDULE - EXCEPT EUROPE, FOR RUSSIA (CONT.)****75,000 km (50,000 miles) or 60months**

- Inspect air cleaner filter  
(for Except China, India, Middle East)
- Inspect air conditioner refrigerant/compressor (if equipped)
- Inspect battery condition
- Inspect brake lines, hoses and connections
- Inspect brake/clutch(if equipped) fluid
- Inspect disc brakes and pads
- Inspect front suspension ball joints
- Inspect power steering fluid and hoses (if equipped)
- Inspect steering gear rack, linkage and boots
- Inspect tire (pressure & tread wear)
- Inspect vacuum hose (for EGR & throttle body) (Gasoline)
- Inspect drive belt (Diesel) - Except Russia \*<sup>9</sup>  
(At first, 80,000km (50,000miles) or 48 months  
after that, every 20,000km (12,500miles) or 12 months)
- Replace air cleaner filter (for China, India, Middle East)
- Replace climate control air filter
- Replace engine oil and filter (Gasoline - MPI)  
- Except Middle East \*<sup>2</sup>
- Replace engine oil and filter (Gasoline - MPI)  
- For Middle East \*<sup>2</sup>  
(Every 10,000 km (6,500 miles) or 12 months\*<sup>3</sup>)

(Continued)

(Continued)

- Replace engine oil and filter (Gasoline - GDI) \*<sup>2</sup>  
- For China  
(Every 5,000 km (3,100 miles) or 6months)
- Replace engine oil and filter (Diesel) - For Russia \*<sup>2</sup> \*<sup>3</sup>
- Replace engine oil and filter (Diesel) - Except Russia \*<sup>2</sup> \*<sup>3</sup>  
(Every 10,000 km (6,500 miles) or 12 months)
- Add fuel additives (Gasoline) \*<sup>10</sup>  
(Every 5,000 km or 6 months)

\* Inspect : Inspect and if necessary, adjust, correct, clean or replace.

## NORMAL MAINTENANCE SCHEDULE - EXCEPT EUROPE, FOR RUSSIA (CONT.)

### 90,000 km (60,000 miles) or 72months

- Inspect air conditioner refrigerant/compressor (if equipped)
- Inspect battery condition
- Inspect brake lines, hoses and connections
- Inspect all electrical system
- Inspect brake/clutch(if equipped) fluid
- Inspect disc brakes and pads
- Inspect drive belt (Gasoline) \*1
- Inspect drive shafts and boots
- Inspect exhaust system
- Inspect front suspension ball joints
- Inspect fuel filter (Gasoline) \*7
- Inspect fuel tank air filter (Gasoline, if equipped)
- Inspect fuel filter cartridge (Diesel) \*4
- Inspect fuel lines, hoses and connections (Diesel)
- Inspect parking brake (Foot/Hand type)
- Inspect power steering fluid and hoses (if equipped)
- Inspect steering gear rack, linkage and boots
- Inspect tire (pressure & tread wear)
- Inspect propeller shaft (if equipped)
- Inspect vacuum hose (for EGR & throttle body) (Gasoline)
- Replace air cleaner filter (for all region)
- Replace climate control air filter

(Continued)

(Continued)

- Replace engine oil and filter (Gasoline - MPI)  
- Except Middle East \*2
- Replace engine oil and filter (Gasoline - MPI)  
- For Middle East \*2  
(Every 10,000 km (6,500 miles) or 12months\*3)
- Replace engine oil and filter (Gasoline - GDI) \*2  
- For China  
(Every 5,000 km (3,100 miles) or 6months)
- Replace engine oil and filter (Diesel) - For Russia \*2 \*3
- Replace engine oil and filter (Diesel) - Except Russia \*2 \*3  
(Every 10,000 km (6,500 miles) or 12months)
- Inspect cooling system  
(At first, 60,000 km (40,000 miles) or 48months  
after that, every 30,000 km (20,000 miles) or 24months)
- Inspect valve clearance (Gasoline) \*6
- Add fuel additives (Gasoline) \*10  
(Every 5,000 km or 6months)
- Inspect drive belt (Diesel) - For Russia \*9  
(At first, 90,000km (60,000 miles) or 48months  
after that, every 30,000km (20,000 miles) or 24 months)
- Inspect drive belt (Diesel) - Except Russia \*9  
(At first, 80,000km (50,000miles) or 48months  
after that, every 20,000km (12,500miles) or 12 months)

\* Inspect : Inspect and if necessary, adjust, correct, clean or replace.

**NORMAL MAINTENANCE SCHEDULE - EXCEPT EUROPE, FOR RUSSIA (CONT.)****105,000 km (70,000 miles) or 84months**

- Inspect air cleaner filter  
(for Except China, India, Middle East)
- Inspect air conditioner refrigerant/compressor (if equipped)
- Inspect battery condition
- Inspect brake lines, hoses and connections
- Inspect brake/clutch(if equipped) fluid
- Inspect disc brakes and pads
- Inspect front suspension ball joints
- Inspect parking brake
- Inspect power steering fluid and hoses (if equipped)
- Inspect steering gear rack, linkage and boots
- Inspect tire (pressure & tread wear)
- Inspect vacuum hose (for EGR & throttle body) (Gasoline)
- Inspect drive belt (Diesel) - Except Russia \*<sup>9</sup>  
(At first, 80,000km (50,000miles) or 48months  
after that, every 20,000km (12,500miles) or 12 months)
- Replace air cleaner filter (for China, India, Middle East)
- Replace climate control air filter
- Replace engine oil and filter (Gasoline - MPI)  
- Except Middle East \*<sup>2</sup>

(Continued)

(Continued)

- Replace engine oil and filter (Gasoline - MPI)  
- For Middle East \*<sup>2</sup>  
(Every 10,000 km (6,500 miles) or 12months\*<sup>3</sup>)
- Replace engine oil and filter (Gasoline - GDI) \*<sup>2</sup>  
- For China  
(Every 5,000 km (3,100 miles) or 6months)
- Replace engine oil and filter (Diesel) - For Russia \*<sup>2</sup> \*<sup>3</sup>
- Replace engine oil and filter (Diesel) - Except Russia \*<sup>2</sup> \*<sup>3</sup>  
(Every 10,000 km (6,500 miles) or 12months)
- Add fuel additives (Gasoline) \*<sup>10</sup>  
(Every 5,000 km or 6months)

\* Inspect : Inspect and if necessary, adjust, correct, clean or replace.

## NORMAL MAINTENANCE SCHEDULE - EXCEPT EUROPE, FOR RUSSIA (CONT.)

### 120,000 km (80,000 miles) or 96months

- Inspect air cleaner filter  
(for Except China, India, Middle East)
- Inspect air conditioner refrigerant/compressor (if equipped)
- Inspect battery condition
- Inspect brake lines, hoses and connections
- Inspect all electrical system
- Inspect brake/clutch(if equipped) fluid
- Inspect disc brakes and pads
- Inspect drive belt (Gasoline) \*1
- Inspect drive shafts and boots
- Inspect exhaust system
- Inspect front suspension ball joints
- Inspect fuel lines, hoses and connections  
(Gasoline, Diesel)
- Inspect parking brake (Foot/Hand type)
- Inspect power steering fluid and hoses (if equipped)
- Inspect steering gear rack, linkage and boots
- Inspect tire (pressure & tread wear)
- Inspect transfer case oil (4WD) \*11
- Inspect rear differential oil (4WD) \*11
- Inspect manual transaxle fluid (if equipped) \*11

(Continued)

### (Continued)

- Inspect vapor hose and fuel filler cap
- Inspect propeller shaft (if equipped)
- Inspect vacuum hose (for EGR & throttle body) (Gasoline)
- Replace air cleaner filter (for China, India, Middle East)
- Replace climate control air filter
- Replace engine oil and filter (Gasoline - MPI)  
- Except Middle East \*2
- Replace engine oil and filter (Gasoline - MPI)  
- For Middle East \*2  
(Every 10,000 km (6,500 miles) or 12months\*3)
- Replace engine oil and filter (Gasoline - GDI) \*2  
- For China  
(Every 5,000 km (3,100 miles) or 6months)
- Replace engine oil and filter (Diesel) - For Russia \*2 \*3
- Replace engine oil and filter (Diesel) - Except Russia \*2 \*3  
(Every 10,000 km (6,500 miles) or 12months)
- Replace fuel filter (Gasoline) \*7
- Replace fuel filter cartridge (Diesel) \*4
- Replace fuel tank air filter (Gasoline, if equipped)
- Replace spark plugs (Gasoline 2.4/3.3L - Iridium) \*5  
(Every 160,000 km (100,000 miles) or 120months)

(Continued)

**NORMAL MAINTENANCE SCHEDULE - EXCEPT EUROPE, FOR RUSSIA (CONT.)**

(Continued)

- Replace coolant \*8  
(At first, 200,000 km (120,000 miles) or 120months after that, every 40,000 km (25,000 miles) or 24months \*5)
- Inspect cooling system  
(At first, 60,000 km (40,000 miles) or 48months after that, every 30,000 km (20,000 miles) or 24months)
- Add fuel additives (Gasoline) \*10  
(Every 5,000 km or 6months)
- Inspect drive belt (Diesel) - For Russia \*9  
(At first, 90,000km (60,000 miles) or 48months after that, every 30,000km (20,000 miles) or 24 months)
- Inspect drive belt (Diesel) - Except Russia \*9  
(At first, 80,000km (50,000miles) or 48months after that, every 20,000km (12,500miles) or 12 months)

**No check, No service required**

- Automatic transaxle fluid

\* Inspect : Inspect and if necessary, adjust, correct, clean or replace.

امداد خودرو فارما

تلفن شبانه روزی: ۰۸۵-۸۸۸۶۲۰۸۵

FarmaSOS.com



## MAINTENANCE UNDER SEVERE USAGE CONDITIONS - EXCEPT EUROPE, FOR RUSSIA

The following items must be serviced more frequently on cars mainly used under severe driving conditions.

Refer to the chart below for the appropriate maintenance intervals.

R : Replace I : Inspect and if necessary, adjust, correct, clean or replace

Maintenance item		Maintenance operation	Maintenance intervals	Driving condition	
Engine oil and engine oil filter	Gasoline - MPI	Except Middle East	R	Every 7,500 km (5,000 miles) or 6 months	A, B, C, D, E, F, G, H, I, J
		For Middle East	R	Every 5,000 km (3,000 miles) or 6 months	
	Gasoline - GDI (For China)		R	Every 5,000 km (3,000 miles) or 6 months	A, B, C, D, E, F, G, H, I, J
	Diesel	For Russia	R	Every 7,500 km (5,000 miles) or 6 months	A, B, C, F, G, H, I, J, K, L
		Except Russia	R	Every 5,000 km (3,000 miles) or 6 months	
Air cleaner filter		R	Replace more frequently depending on the condition	C, E	
Manual transaxle fluid (if equipped)		R	Every 120,000 km (80,000 miles)	C, E, F, G, I, J	
Automatic transaxle fluid (if equipped)		R	Every 100,000 km (62,500 miles)	A, C, D, E, F, G, H, I, J	
Steering gear rack, linkage and boots		I	Inspect more frequently depending on the condition	C, D, E, F, G	
Front suspension ball joints		I	Inspect more frequently depending on the condition	C, D, E, F, G	

Maintenance item	Maintenance operation	Maintenance intervals	Driving condition
Disc brakes and pads, calipers and rotors	I	Inspect more frequently depending on the condition	C, D, E, G, H
Parking brake (Foot/Hand type)	I	Inspect more frequently depending on the condition	C, D, G, H
Driveshaft and boots	I	Inspect more frequently depending on the condition	C, D, E, F, G, H, I, J
Climate control air filter	R	Replace more frequently depending on the condition	C, E, G
Spark plugs	R	Replace more frequently depending on the condition	B, H
Rear differential oil (4WD)	R	Every 120,000 km (80,000 miles)	C, D, E, G, H, I, K
Transfer case oil (4WD)	R	Every 120,000 km (80,000 miles)	C, D, E, G, H, I, K
Propeller shaft (if equipped)	I	Every 15,000 km (10,000 miles) or 12 months	C, E

### Severe driving conditions

- A : Repeated short distance driving  
 B : Extensive idling  
 C : Driving in dusty, rough roads  
 D : Driving in areas using salt or other corrosive materials or in very cold weather  
 E : Driving in sandy areas  
 F : More than 50 % driving in heavy city traffic during hot weather above 32°C (90°F)

- G : Driving in mountainous areas.  
 H : Towing a trailer or using a camper on roof rack  
 I : Driving for patrol car, taxi, commercial car or vehicle towing  
 J : Driving in very cold weather  
 K : Driving over 170 km/h (106 mile/h)  
 L : Frequently driving in stop-and-go conditions

## EXPLANATION OF SCHEDULED MAINTENANCE ITEMS

### Engine oil and filter

The engine oil and filter should be changed at the intervals specified in the maintenance schedule. If the car is being driven in severe conditions, more frequent oil and filter changes are required.

### Drive belts

Inspect all drive belts for evidence of cuts, cracks, excessive wear or oil saturation and replace if necessary. Drive belts should be checked periodically for proper tension and adjusted as necessary.

#### CAUTION

*When you are inspecting the belt, place the ignition switch in the LOCK/OFF or ACC position.*

### Fuel filter (cartridge)

A clogged filter can limit the speed at which the vehicle may be driven, damage the emission system and cause multiple issues such as hard starting. If an excessive amount of foreign matter accumulates in the fuel tank, the filter may require replacement more frequently.

After installing a new filter, run the engine for several minutes, and check for leaks at the connections. We recommend that the fuel filter be replaced by an authorized HYUNDAI dealer.

تلفن شبانه روزی: ۰۲۱-۸۸۸۶۲۰۸۵

FarmaSOS.com

### Fuel lines, fuel hoses and connections

Check the fuel lines, fuel hoses and connections for leakage and damage. We recommend that the fuel lines, fuel hoses and connections be replaced by an authorized HYUNDAI dealer.

#### WARNING - Diesel only

**Never work on injection system with engine running or within 30 seconds after shutting off engine. High pressure pump, rail, injectors and high pressure pipes are subject to high pressure even after the engine stopped. The fuel jet produced by fuel leaks may cause serious injury, if it touch the body. People using pacemakers should not move than 30cm closer to the ECU or wiring harness within the engine room while engine is running, since the high currents in the Common Rail system produce considerable magnetic fields.**

### Vapor hose and fuel filler cap

The vapor hose and fuel filler cap should be inspected at those intervals specified in the maintenance schedule. Make sure that a new vapor hose or fuel filler cap is correctly replaced.

### Vacuum crankcase ventilation hoses (if equipped)

Inspect the surface of hoses for evidence of heat and/or mechanical damage. Hard and brittle rubber, cracking, tears, cuts, abrasions, and excessive swelling indicate deterioration. Particular attention should be paid to examine those hose surfaces nearest to high heat sources, such as the exhaust manifold.

Inspect the hose routing to assure that the hoses do not come in contact with any heat source, sharp edges or moving component which might cause heat damage or mechanical wear. Inspect all hose connections, such as clamps and couplings, to make sure they are secure, and that no leaks are present. Hoses should be replaced immediately if there is any evidence of deterioration or damage.

### Air cleaner filter

We recommend that the air cleaner filter be replaced by an authorized HYUNDAI dealer.

### Spark plugs (for gasoline engine)

Make sure to install new spark plugs of the correct heat range.

#### **WARNING**

**Do not disconnect and inspect spark plugs when the engine is hot. You may burn yourself.**

### Valve clearance (for gasoline engine)

Inspect excessive valve noise and/or engine vibration and adjust if necessary. We recommend that the system be serviced by an authorized HYUNDAI dealer.

### Cooling system

Check the cooling system parts, such as radiator, coolant reservoir, hoses and connections for leakage and damage. Replace any damaged parts.

### Coolant

The coolant should be changed at the intervals specified in the maintenance schedule.

### Manual transaxle fluid (if equipped)

Inspect the manual transaxle fluid according to the maintenance schedule.

### Automatic transaxle fluid (if equipped)

Automatic transaxle fluid should not be checked under normal usage conditions.

We recommend that the automatic transaxle fluid changed by an authorized HYUNDAI dealer according to the maintenance schedule.

#### \* NOTICE

Automatic transaxle fluid color is basically red.

As the vehicle is driven, the automatic transaxle fluid will begin to look darker.

It is normal condition and you should not judge the need to replace the fluid based upon the changed color.



#### CAUTION

*The use of a non-specified fluid could result in transaxle malfunction and failure.*

*Use only specified automatic transaxle fluid. (Refer to "Recommended lubricants and capacities" in section 8.)*

### Brake hoses and lines

Visually check for proper installation, chafing, cracks, deterioration and any leakage. Replace any deteriorated or damaged parts immediately.

### Brake fluid

Check brake fluid level in the brake fluid reservoir. The level should be between "MIN" and "MAX" marks on the side of the reservoir. Use only hydraulic brake fluid conforming to DOT 3 or DOT 4 specification.

### Parking brake

Inspect the parking brake system including the parking brake lever (or pedal) and cables.

### **Brake pads, calipers and rotors**

Check the pads for excessive wear, discs for run out and wear, and calipers for fluid leakage.

For more information on checking the pads or lining wear limit, refer to the HYUNDAI web site.

(<http://brakemanual.hmc.co.kr>)

### **Suspension mounting bolts**

Check the suspension connections for looseness or damage. Retighten to the specified torque.

### **Steering gear box, linkage & boots/lower arm ball joint**

With the vehicle stopped and engine off, check for excessive free-play in the steering wheel.

Check the linkage for bends or damage. Check the dust boots and ball joints for deterioration, cracks, or damage. Replace any damaged parts.

### **Power steering pump, belt and hoses**

Check the power steering pump and hoses for leakage and damage. Replace any damaged or leaking parts immediately. Inspect the power steering belt (or drive belt) for evidence of cuts, cracks, excessive wear, oiliness and proper tension. Replace or adjust it if necessary.

### **Drive shafts and boots**

Check the drive shafts, boots and clamps for cracks, deterioration, or damage. Replace any damaged parts and, if necessary, repack the grease.

### **Air conditioning refrigerant/compressor**

Check the air conditioning lines and connections for leakage and damage.

## ENGINE OIL

### Checking the engine oil level

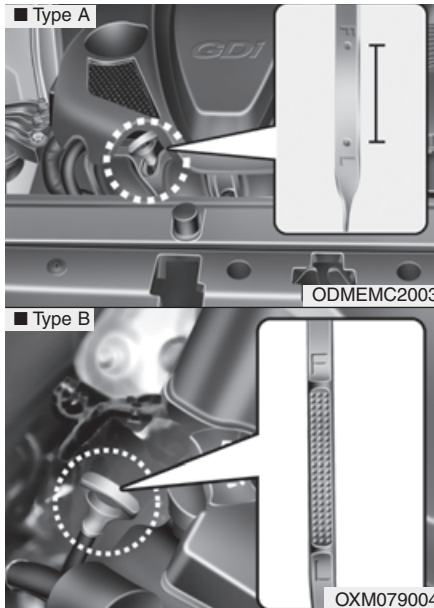

1. Be sure the vehicle is on level ground.
2. Start the engine and allow it to reach normal operating temperature.

3. Turn the engine off and wait for a few minutes (about 5 minutes) for the oil to return to the oil pan.
4. Pull the dipstick out, wipe it clean, and re-insert it fully.

#### **⚠ WARNING - Radiator hose**

**Be very careful not to touch the radiator hose when checking or adding the engine oil as it may be hot enough to burn you.**

5. Pull the dipstick out again and check the level. The level should be between F and L.

FarmaSOS.com

#### **⚠ CAUTION**

- **Do not overfill the engine oil. It may damage the engine.**
- **Do not spill engine oil, when adding or changing engine oil. If you drop the engine oil on the engine room, wipe it off immediately.**
- **When you wipe the oil level gauge, you should wipe it with a clean cloth. When mixed with debris, it can cause engine damage.**

#### **⚠ CAUTION - Diesel engine**

**Overfilling the engine oil may cause severe dieseling due to churning effect. It may lead to engine damage accompanied with abrupt engine speed increment, combustion noise and white smoke emission.**

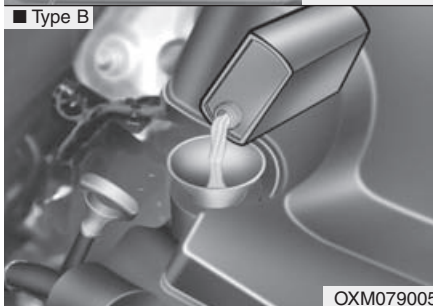
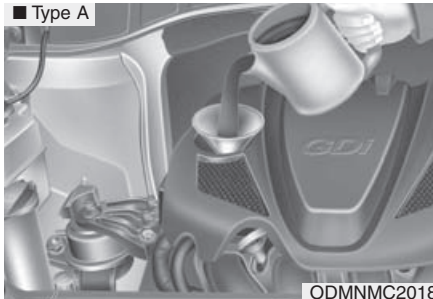

If it is near or at L, add enough oil to bring the level to F. **Do not overfill.**

**Use a funnel to help prevent oil from being spilled on engine components.**

*Use only the specified engine oil. (Refer to “Recommended lubricants and capacities” in section 8.)*

## Changing the engine oil and filter



We recommend that the engine oil and filter be replaced by an authorized HYUNDAI dealer.

[FarmaSOS.com](http://FarmaSOS.com)

### **⚠ WARNING**

Used engine oil may cause irritation or cancer of the skin if left in contact with the skin for prolonged periods of time. Used engine oil contains chemicals that have caused cancer in laboratory animals. Always protect your skin by washing your hands thoroughly with soap and warm water as soon as possible after handling used oil.



## ENGINE COOLANT

The high-pressure cooling system has a reservoir filled with year-round antifreeze coolant. The reservoir is filled at the factory.

Check the antifreeze protection and coolant concentration level at least once a year, at the beginning of the winter season, and before traveling to a colder climate.

### CAUTION

- *Do not drive with no engine coolant. It may cause water pump failure and engine seizure, etc.*
- *When the engine overheats from low engine coolant, suddenly adding engine coolant may cause cracks in the engine. To prevent damage, add engine coolant slowly in small quantities.*

## Checking the coolant level

### WARNING



### Removing radiator cap

- Never attempt to remove the radiator cap while the engine is operating or hot. Doing so might lead to cooling system and engine damage and could result in serious personal injury from escaping hot coolant or steam.
- Turn the engine off and wait until it cools down. Use extreme care when removing the radiator cap. Wrap a thick towel around it, and turn it counterclockwise slowly to the first stop. Step back while the pressure is released from the cooling system.

(Continued)

(Continued)

When you are sure all the pressure has been released, press down on the cap, using a thick towel, and continue turning counterclockwise to remove it.

- Even if the engine is not operating, do not remove the radiator cap or the drain plug while the engine and radiator are hot. Hot coolant and steam may still blow out under pressure, causing serious injury.

**⚠ WARNING**

The electric motor (cooling fan) is controlled by engine coolant temperature, refrigerant pressure and vehicle speed. It may sometimes operate even when the engine is not running. Use extreme caution when working near the blades of the cooling fan so that you are not injured by a rotating fan blades. As the engine coolant temperature decreases, the electric motor will automatically shut off. This is a normal condition.

If your vehicle is equipped with GDI, the electric motor (cooling fan) may operate until you disconnect the negative battery cable.

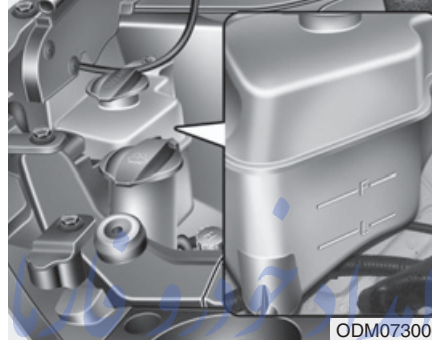

Check the condition and connections of all cooling system hoses and heater hoses. Replace any swollen or deteriorated hoses. تلفن شبانه روزی:

The coolant level should be filled between F (MAX) and L (MIN) marks on the side of the coolant reservoir when the engine is cool.

If the coolant level is low, add enough distilled (deionized) or soft water. Bring the level to F (MAX), but do not overfill.

If frequent additions are required, we recommend that the system be inspected by an authorized HYUNDAI dealer.

***Recommended engine coolant***

- When adding coolant, use only deionized water or soft water for your vehicle and never mix hard water in the coolant filled at the factory. An improper coolant mixture can result in serious malfunction or engine damage.
- The engine in your vehicle has aluminum engine parts and must be protected by an ethylene-glycol-based coolant to prevent corrosion and freezing.
- DO NOT USE alcohol or methanol coolant or mix them with the specified coolant.
- Do not use a solution that contains more than 60% antifreeze or less than 35% antifreeze, which would reduce the effectiveness of the solution.

For mixture percentage, refer to the following table.

Ambient Temperature	Mixture Percentage (volume)	
	Antifreeze	Water
-15°C (5°F)	35	65
-25°C (-13°F)	40	60
-35°C (-31°F)	50	50
-45°C (-49°F)	60	40

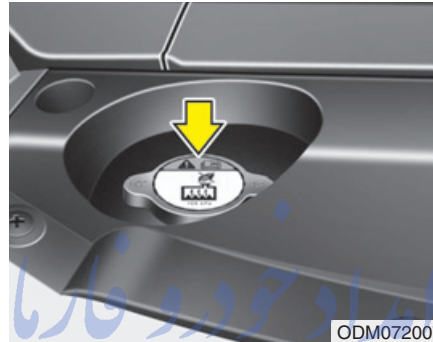

## WARNING



Radiator cap

Do not remove the radiator cap when the engine and radiator are hot. Scalding hot coolant and steam may blow out under pressure causing serious injury.

## Changing the coolant

We recommend that the coolant be replaced by an authorized HYUNDAI dealer.

### CAUTION

*Put a thick cloth or fabric around the radiator cap before refilling the coolant in order to prevent the coolant from overflowing into engine parts such as generator.*

### WARNING - Coolant

- Do not use radiator coolant or antifreeze in the washer fluid reservoir.
- Radiator coolant can severely obscure visibility when sprayed on the windshield and may cause loss of vehicle control or damage to paint and body trim.

## BRAKE/CLUTCH FLUID (IF EQUIPPED)

### Checking the brake/clutch fluid level

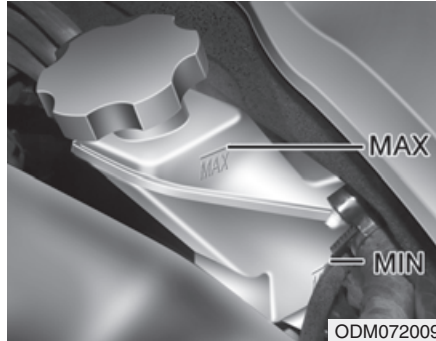

Check the fluid level in the reservoir periodically. The fluid level should be between MAX and MIN marks on the side of the reservoir. Before removing the reservoir cap and adding brake/clutch fluid, clean the area around the reservoir cap thoroughly to prevent brake/clutch fluid contamination. If the level is low, add fluid to the MAX level. The level will fall with accumulated mileage. This is a normal condition associated with the wear of the brake linings. If the fluid level is excessively low, we recommend that the system be checked by an authorized HYUNDAI dealer.

*Use only the specified brake/clutch fluid. (Refer to "Recommended lubricants and capacities" in section 8.)*

*Never mix different types of fluid.*

#### **⚠ WARNING - Loss of brake/clutch fluid**

In the event the brake/clutch system requires frequent additions of fluid, we recommend that the system be inspected by an authorized HYUNDAI dealer.

\* **NOTICE**  
 Before removing the brake/clutch filter cap, read the warning on the cap.

#### **⚠ WARNING**

Clean filler cap before removing. Use only DOT3 or DOT4 brake/clutch fluid from a sealed container.

#### **⚠ WARNING - Brake/clutch fluid**

When changing and adding brake/clutch fluid, handle it carefully. Do not let it come in contact with your eyes. If brake/clutch fluid should come in contact with your eyes, immediately flush them with a large quantity of fresh tap water. Have your eyes examined by a doctor as soon as possible.

#### **⚠ CAUTION**

Do not allow brake/clutch fluid to contact the vehicle's body paint, as paint damage will result. Brake/clutch fluid, which has been exposed to open air for an extended time should never be used as its quality cannot be guaranteed. It should be disposed of properly. Don't put in the wrong kind of fluid. A few drops of mineral-based oil, such as engine oil, in your brake/clutch system can damage brake/clutch system parts.

## POWER STEERING FLUID (IF EQUIPPED)

### Checking the power steering fluid level

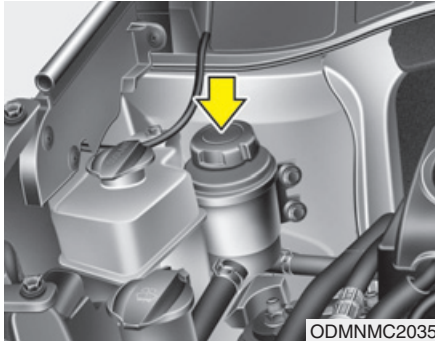

With the vehicle on level ground, check the fluid level in the power steering reservoir periodically. The fluid should be between MAX and MIN marks on the side of the reservoir at the normal temperature.

Before adding power steering fluid, thoroughly clean the area around the reservoir cap to prevent power steering fluid contamination.

If the level is low, add fluid to the MAX level.

### \* NOTICE

Check that the fluid level is in the "HOT" range on the reservoir. If the fluid is cold, check that it is in the "COLD" range.

In the event the power steering system requires frequent additions of fluid, we recommend that the system be inspected by an authorized HYUNDAI dealer.

### ⚠ CAUTION

- **To avoid damage to the power steering pump, do not operate the vehicle for prolonged periods with a low power steering fluid level.**
- **Never start the engine when the reservoir tank is empty.**
- **When adding fluid, be careful that dirt does not get into the tank.**
- **Too little fluid can result in increased steering effort and/or noise from the power steering system.**

(Continued)

(Continued)

- **The use of the non-specified fluid could reduce the effectiveness of the power steering system and cause damage to it.**

Use only the specified power steering fluid. (Refer to "Recommended lubricants or capacities" in section 8.)

### Checking the power steering hose

Check the connections for oil leaks, damage and twists in the power steering hose before driving.

## WASHER FLUID

### Checking the washer fluid level

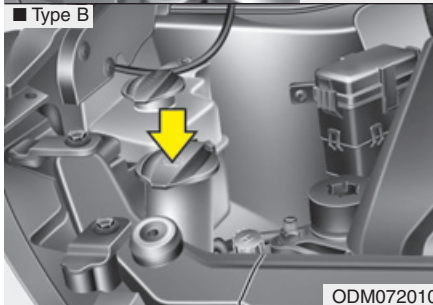
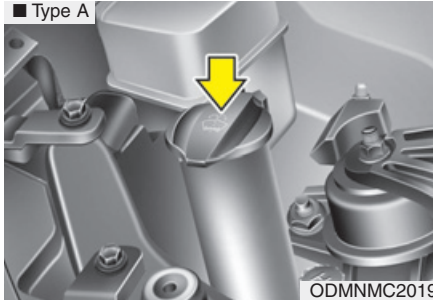

The reservoir is translucent so that you can check the level with a quick visual inspection.

Check the fluid level in the washer fluid reservoir and add fluid if necessary.

Plain water may be used if washer fluid is not available.

However, use washer solvent with antifreeze characteristics in cold climates to prevent freezing.

امداد خودرو فارما

تلفن شبانه روزی: ۰۲۱-۸۸۸۶۲۰۸۵

FarmaSOS.com

### **⚠ WARNING - Coolant**

- Do not use radiator coolant or antifreeze in the washer fluid reservoir.
- Radiator coolant can severely obscure visibility when sprayed on the windshield and may cause loss of vehicle control or damage to paint and body trim.
- Windshield Washer fluid agents contain some amounts of alcohol and can be flammable under certain circumstances. Do not allow sparks or flame to contact the washer fluid or the washer fluid reservoir. Damage to the vehicle or occupants could occur.
- Windshield washer fluid is poisonous to humans and animals. Do not drink and avoid contacting windshield washer fluid. Serious injury or death could occur.

## PARKING BRAKE

### Checking the parking brake

#### Type A

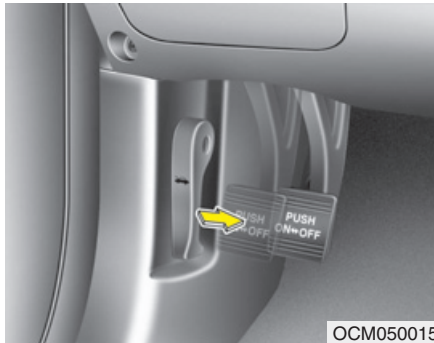

Check whether the stroke is within specification when the parking brake pedal is depressed with 30 kg (66 lb, 294N) of force. Also, the parking brake alone should securely hold the vehicle on a fairly steep grade. If the stroke is more or less than specified, we recommend that the system be serviced by an authorized HYUNDAI dealer.

**Stroke : 8~9 notch**

#### Type B

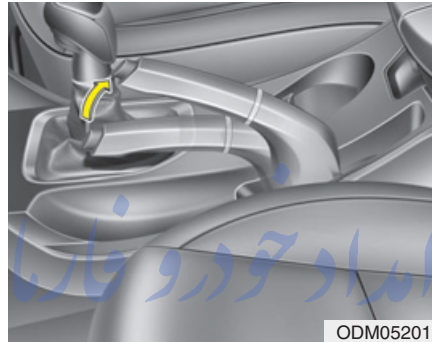

Check the stroke of the parking brake by counting the number of “clicks” heard while fully applying it from the released position. Also, the parking brake alone should securely hold the vehicle on a fairly steep grade. If the stroke is more or less than specified, we recommend that the system be serviced by an authorized HYUNDAI dealer.

**Stroke : 5~6 “clicks” at a force of 20 kg (44 lbs, 196 N).**

## FUEL FILTER (FOR DIESEL)

### Draining water from fuel filter

The fuel filter for diesel engine plays an important role of separating water from fuel and accumulating the water in its bottom.

If water accumulates in the fuel filter, the warning light comes on when the ignition switch is in the ON position.



If this warning light turned on, we recommend that the system be serviced by an authorized HYUNDAI dealer.

### **CAUTION**

*If the water accumulated in the fuel filter is not drained at proper times, damages to the major parts such as the fuel system can be caused by water permeation in the fuel filter.*

### Fuel filter cartridge replacement

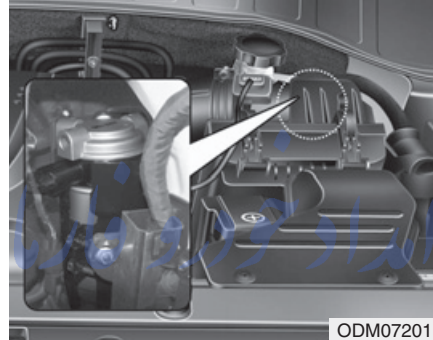

### \* NOTICE

When replacing the fuel filter cartridge, we recommend that you use parts for replacement from an authorized HYUNDAI dealer.

تلفن شبانه روزی: ۰۲۱-۸۸۸۶۲۰۸۵



## AIR CLEANER

### Filter replacement

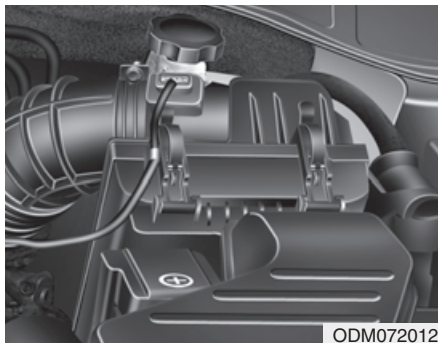

It must be replaced when necessary, and should not be washed.

You can clean the filter when inspecting the air cleaner element.

Clean the filter by using compressed air.

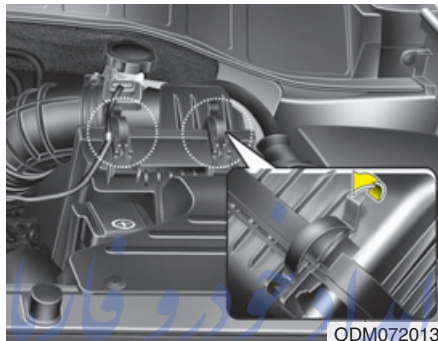

1. Loosen the air cleaner cover attaching clips and open the cover.

تلفن شبانه روزی: ۰۲۱-۸۸۸۶۲۰۸۵

FarmaSOS.com

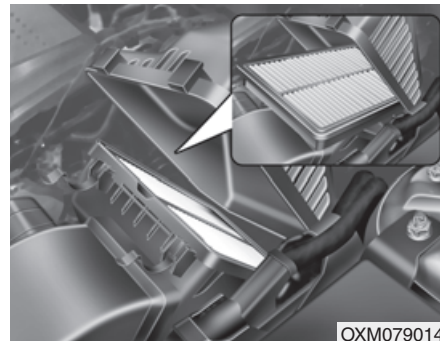

2. Wipe the inside of the air cleaner.

3. Replace the air cleaner filter.

4. Lock the cover with the cover attaching clips.

Replace the filter according to the Maintenance Schedule.

*If the vehicle is operated in extremely dusty or sandy areas, replace the element more often than the usual recommended intervals. (Refer to "Maintenance under severe usage conditions" in this section.)*

 **CAUTION**

- ***Do not drive with the air cleaner removed; this will result in excessive engine wear.***
- ***When removing the air cleaner filter, be careful that dust or dirt does not enter the air intake, or damage may result.***
- ***We recommend that you use parts for replacement from an authorized HYUNDAI dealer.***

تلفن شبانه روزی: ۰۲۱-۸۸۸۶۲۰۸۵

FarmaSOS.com

## CLIMATE CONTROL AIR FILTER

### Filter inspection

If the vehicle is operated in the severely air-polluted cities or on dusty rough roads for a long period, it should be inspected more frequently and replaced earlier. When you, the owner, replace the climate control air filter, replace it performing the following procedure, and be careful to avoid damaging other components.

Replace the filter according to the maintenance Schedule.

### Filter replacement

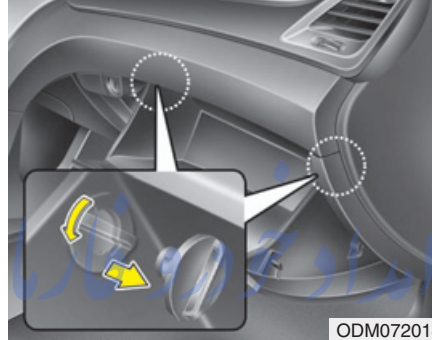

1. Open the glove box and remove the support strap.

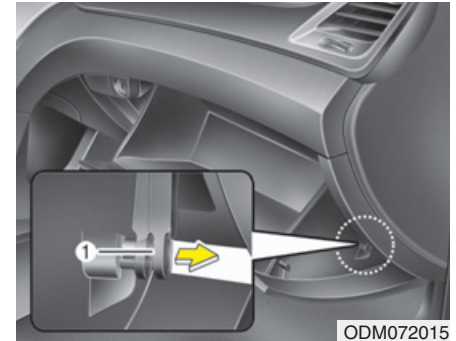

2. With the glove box open, remove the stoppers on both sides.

FarmaSOS.com

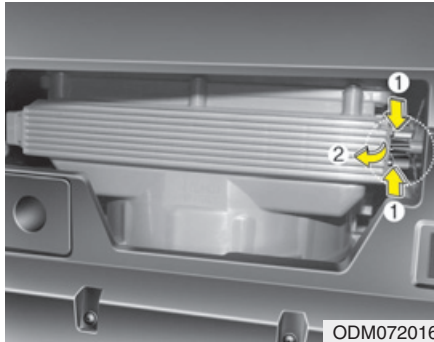

3. Remove the climate control air filter case while pressing the lock on the right of the cover.



4. Replace the climate control air filter.
5. Reassemble in the reverse order of disassembly.

#### \* NOTICE

When replacing the climate control air filter install it properly. Otherwise, the system may produce noise and the effectiveness of the filter may be reduced.

## WIPER BLADES

### Blade inspection

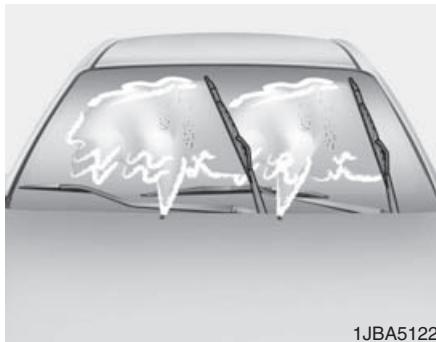

1JBA5122

### \* NOTICE

Commercial hot waxes applied by automatic car washes have been known to make the windshield difficult to clean.

Contamination of either the windshield or the wiper blades with foreign matter can reduce the effectiveness of the windshield wipers. Common sources of contamination are insects, tree sap, and hot wax treatments used by some commercial car washes. If the blades are not wiping properly, clean both the window and the blades with a good cleaner or mild detergent, and rinse thoroughly with clean water.

### CAUTION

*To prevent damage to the wiper blades, do not use gasoline, kerosene, paint thinner, or other solvents on or near them.*

### Blade replacement

When the wipers no longer clean adequately, the blades may be worn or cracked, and require replacement.

### CAUTION

*To prevent damage to the wiper arms or other components, do not attempt to move the wipers manually.*

### CAUTION

*The use of a non-specified wiper blade could result in wiper malfunction and failure.*

FarmaSOS.com

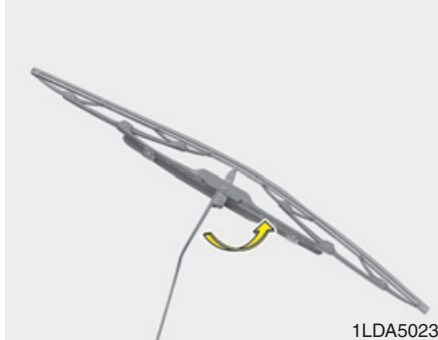
**Front windshield wiper blade****Type A**

1. Raise the wiper arm and turn the wiper blade assembly to expose the plastic locking clip.

**⚠ CAUTION**

***Do not allow the wiper arm to fall against the windshield, since it may chip or crack the windshield.***

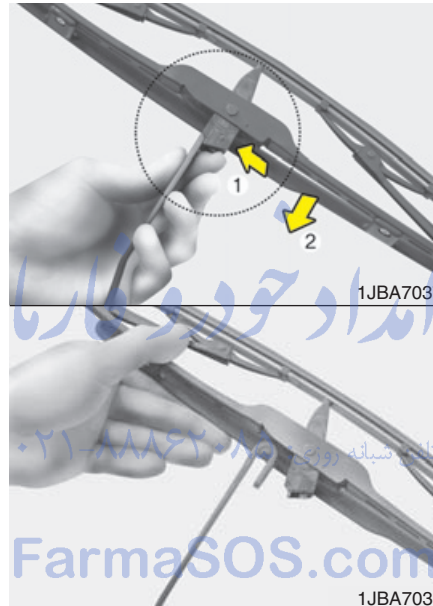

2. Compress the clip and slide the blade assembly downward.
3. Lift it off the arm.
4. Install the blade assembly in the reverse order of removal.

**Type B**

1. Raise the wiper arm.

**⚠ CAUTION**

***Do not allow the wiper arm to fall against the windshield, since it may chip or crack the windshield.***

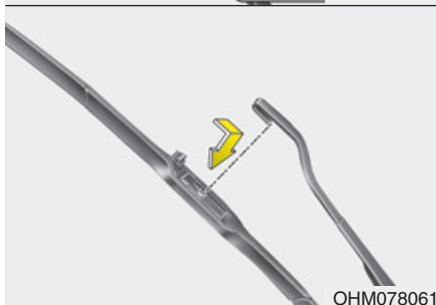
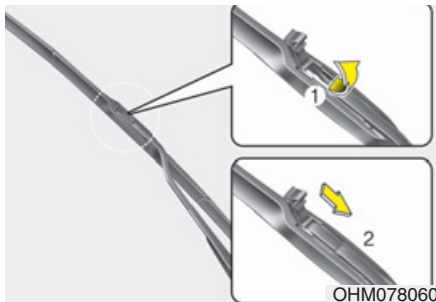

2. Lift up the wiper blade clip. Then pull down the blade assembly and remove it.
3. Install the new blade assembly in the reverse order of removal.

### Rear window wiper blade

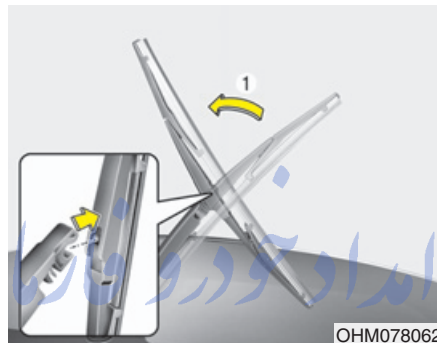

1. Raise the wiper arm and pull out the wiper blade assembly.

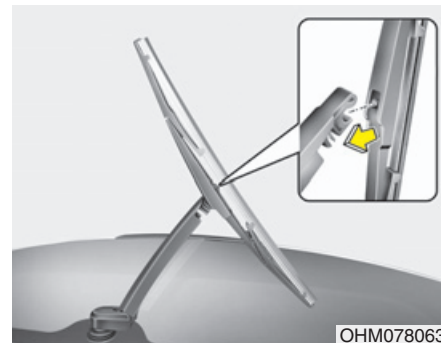

2. Install the new blade assembly by inserting the center part into the slot in the wiper arm until it clicks into place.
3. Make sure the blade assembly is installed firmly by trying to pull it slightly.

To prevent damage to the wiper arms or other components, we recommend that the wiper blade be replaced by an authorized HYUNDAI dealer.

FarmaSOS.com

## BATTERY

### For best battery service

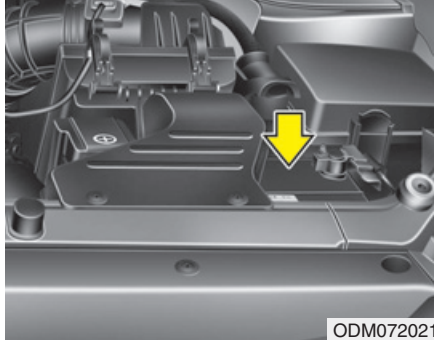

- Keep the battery securely mounted.
- Keep the battery top clean and dry.
- Keep the terminals and connections clean, tight, and coated with petroleum jelly or terminal grease.
- Rinse any spilled electrolyte from the battery immediately with a solution of water and baking soda.
- If the vehicle is not going to be used for an extended time, disconnect the battery cables.

### \* NOTICE

Basically equipped battery is maintenance free type. If your vehicle is equipped with the battery marked with LOWER and UPPER on the side, you can check the electrolyte level. The electrolyte level should be between LOWER and UPPER. If the electrolyte level is low, it needs to add distilled (demineralized) water (Never add sulfuric acid or other electrolyte). When refill, be careful not to splash the battery and adjacent components. And do not overfill the battery cells. It can cause corrosion on other parts. After then ensure that tighten the cell caps. We recommend that you contact an authorized HYUNDAI dealer.

FarmasOS.com

### **⚠ WARNING - Battery**

#### **dangers**



Always read the following instructions carefully when handling a battery.



Keep lighted cigarettes and all other flames or sparks away from the battery.



Hydrogen, a highly combustible gas, is always present in battery cells and may explode if ignited.



Keep batteries out of the reach of children because batteries contain highly corrosive SULFURIC ACID. Do not allow battery acid to contact your skin, eyes, clothing or paint finish.

(Continued)



(Continued)



If any electrolyte gets into your eyes, flush your eyes with clean water for at least 15 minutes and get immediate medical attention. If electrolyte gets on your skin, thoroughly wash the contacted area. If you feel a pain or a burning sensation, get medical attention immediately.



Wear eye protection when charging or working near a battery. Always provide ventilation when working in an enclosed space.



An inappropriately disposed battery can be harmful to the environment and human health. Dispose the battery according to your local law(s) or regulation.

(Continued)

(Continued)

- When lifting a plastic-cased battery, excessive pressure on the case may cause battery acid to leak, resulting in personal injury. Lift with a battery carrier or with your hands on opposite corners.
- Never attempt to recharge the battery when the battery cables are connected.
- The electrical ignition system works with high voltage. Never touch these components with the engine running or the ignition switched on.

Failure to follow the above warnings can result in serious bodily injury or death.

**CAUTION**

*If you connect unauthorized electronic devices to the battery, the battery may be discharged. Never use unauthorized devices.*

**Battery capacity label**

■ Example



OJD702039

\* The actual battery label in the vehicle may differ from the illustration.

1. CMF60L-BCI : The HYUNDAI model name of battery
2. 12V : The nominal voltage
3. 60Ah(20HR) : The nominal capacity (in Ampere hours)
4. 92RC : The nominal reserve capacity (in min.)
5. 550CCA : The cold-test current in amperes by SAE
6. 440A : The cold-test current in amperes by EN

## Battery recharging

Your vehicle has a maintenance-free, calcium-based battery.

- If the battery becomes discharged in a short time (because, for example, the headlights or interior lights were left on while the vehicle was not in use), recharge it by slow charging (trickle) for 10 hours.
- If the battery gradually discharges because of high electric load while the vehicle is being used, recharge it at 20-30A for two hours.

### **⚠ WARNING - Recharging battery**

When recharging the battery, observe the following precautions:

- The battery must be removed from the vehicle and placed in an area with good ventilation.
- Do not allow cigarettes, sparks, or flame near the battery.

(Continued)

(Continued)

- Watch the battery during charging, and stop or reduce the charging rate if the battery cells begin gassing (boiling) violently or if the temperature of the electrolyte of any cell exceeds 49°C (120°F).
- Wear eye protection when checking the battery during charging.
- Disconnect the battery charger in the following order.
  1. Turn off the battery charger main switch.
  2. Unhook the negative clamp from the negative battery terminal.
  3. Unhook the positive clamp from the positive battery terminal.

(Continued)

(Continued)

- Before performing maintenance or recharging the battery, turn off all accessories and stop the engine.
- The negative battery cable must be removed first and installed last when the battery is disconnected.

## Reset items

Items should be reset after the battery has been discharged or the battery has been disconnected.

- Auto up/down window (See section 4)
- Sunroof (See section 4)
- Trip computer (See section 4)
- Climate control system (See section 4)
- Clock (See section 4)
- Audio (See section 4)

## TIRES AND WHEELS

### Tire care

For proper maintenance, safety, and maximum fuel economy, you must always maintain recommended tire inflation pressures and stay within the load limits and weight distribution recommended for your vehicle.

### Recommended cold tire inflation pressures

All tire pressures (including the spare) should be checked when the tires are cold. "Cold Tires" means the vehicle has not been driven for at least three hours or driven less than 1.6 km (1 mile).

Recommended pressures must be maintained for the best ride, top vehicle handling, and minimum tire wear. For recommended inflation pressure refer to "Tire and wheels" in section 8.

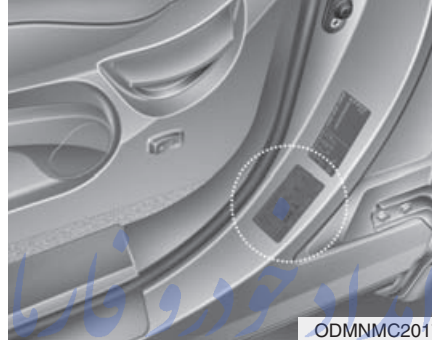

All specifications (sizes and pressures) can be found on a label attached to the vehicle.

تلفن شبانه روزی: ۰۲۱-۸۸۸۶۲۰۸۵

FarmaSOS.com

### **⚠ WARNING - Tire under-inflation**

Severe underinflation (70 kPa (10 psi) or more) can lead to severe heat build-up, causing blowouts, tread separation and other tire failures that can result in the loss of vehicle control leading to severe injury or death. This risk is much higher on hot days and when driving for long periods at high speeds.

**⚠ CAUTION**

- *Underinflation also results in excessive wear, poor handling and reduced fuel economy. Wheel deformation also is possible. Keep your tire pressures at the proper levels. If a tire frequently needs refilling, we recommend that the system be checked by an authorized HYUNDAI dealer.*
- *Overinflation produces a harsh ride, excessive wear at the center of the tire tread, and a greater possibility of damage from road hazards.*

**⚠ CAUTION**

- *Warm tires normally exceed recommended cold tire pressures by 28 to 41 kPa (4 to 6 psi). Do not release air from warm tires to adjust the pressure or the tires will be under-inflated.*
- *Be sure to reinstall the tire inflation valve caps. Without the valve cap, dirt or moisture could get into the valve core and cause air leakage. If a valve cap is missing, install a new one as soon as possible.*

**⚠ WARNING -  
Tire inflation**

Overinflation or underinflation can reduce tire life, adversely affect vehicle handling, and lead to sudden tire failure. This could result in loss of vehicle control and potential injury.

**⚠ CAUTION - Tire pressure**

Always observe the following:

- *Check tire pressure when the tires are cold. (After vehicle has been parked for at least three hours or hasn't been driven more than 1.6 km (1 mile) since startup.)*
- *Check the pressure of your spare tire each time you check the pressure of other tires.*
- *Never overload your vehicle. Be careful not to overload a vehicle luggage rack if your vehicle is equipped with one.*
- *Worn, old tires can cause accidents. If your tread is badly worn, or if your tires have been damaged, replace them.*

### Checking tire inflation pressure

Check your tires once a month or more.

Also, check the tire pressure of the spare tire.

#### *How to check*

Use a good quality gage to check tire pressure. You can not tell if your tires are properly inflated simply by looking at them. Radial tires may look properly inflated even when they're underinflated.

Check the tire's inflation pressure when the tires are cold. - "Cold" means your vehicle has been sitting for at least three hours or driven no more than 1.6 km (1 mile).

Remove the valve cap from the tire valve stem. Press the tire gage firmly onto the valve to get a pressure measurement. If the cold tire inflation pressure matches the recommended pressure on the tire and loading information label, no further adjustment is necessary. If the pressure is low, add air until you reach the recommended amount.

If you overfill the tire, release air by pushing on the metal stem in the center of the tire valve. Recheck the tire pressure with the tire gage. Be sure to put the valve caps back on the valve stems. They help prevent leaks by keeping out dirt and moisture.

FarmaSOS.com

### **⚠ WARNING**

- **Inspect your tires frequently for proper inflation as well as wear and damage. Always use a tire pressure gage.**
- **Tires with too much or too little pressure wear unevenly causing poor handling, loss of vehicle control, and sudden tire failure leading to accidents, injuries, and even death. The recommended cold tire pressure for your vehicle can be found in this manual and on the tire label located on the driver's side center pillar.**
- **Worn tires can cause accidents. Replace tires that are worn, show uneven wear, or are damaged.**
- **Remember to check the pressure of your spare tire. HYUNDAI recommends that you check the spare every time you check the pressure of the other tires on your vehicle.**

## Tire rotation

To equalize tread wear, it is recommended that the tires be rotated every 12,000 km (7,500 miles) or sooner if irregular wear develops.

During rotation, check the tires for correct balance.

When rotating tires, check for uneven wear and damage. Abnormal wear is usually caused by incorrect tire pressure, improper wheel alignment, out-of-balance wheels, severe braking or severe cornering. Look for bumps or bulges in the tread or side of tire. Replace the tire if you find either of these conditions. Replace the tire if fabric or cord is visible. After rotation, be sure to bring the front and rear tire pressures to specification and check lug nut tightness.

Refer to “Tire and wheels” in section 8.

With a full-size spare tire (if equipped)

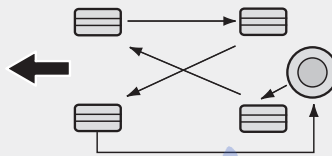

S2BLA790

Without a spare tire

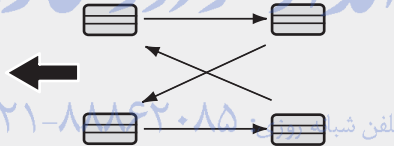

S2BLA790A

Directional tires (if equipped)

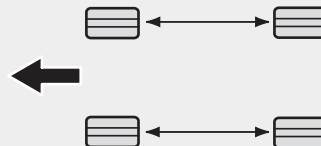

CBGQ0707A

*Disc brake pads should be inspected for wear whenever tires are rotated.*

### \* NOTICE

Rotate radial tires that have an asymmetric tread pattern only from front to rear and not from right to left.

### ⚠ WARNING

- Do not use the compact spare tire for tire rotation.
- Do not mix bias ply and radial ply tires under any circumstances. This may cause unusual handling characteristics that could result in death, severe injury, or property damage.

## Wheel alignment and tire balance

The wheels on your vehicle were aligned and balanced carefully at the factory to give you the longest tire life and best overall performance.

In most cases, you will not need to have your wheels aligned again. However, if you notice unusual tire wear or your vehicle pulling one way or the other, the alignment may need to be reset.

If you notice your vehicle vibrating when driving on a smooth road, your wheels may need to be rebalanced.

### CAUTION

***Improper wheel weights can damage your vehicle's aluminum wheels. Use only approved wheel weights.***

## Tire replacement

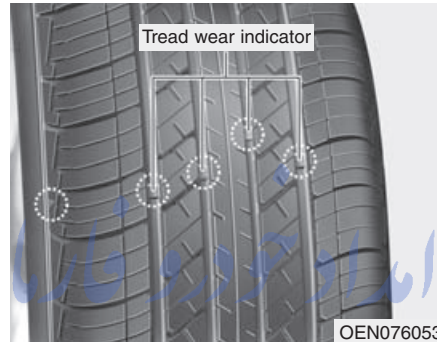

If the tire is worn evenly, a tread wear indicator will appear as a solid band across the tread. This shows there is less than 1.6 mm (1/16 in.) of tread left on the tire. Replace the tire when this happens.

Do not wait for the band to appear across the entire tread before replacing the tire.

### CAUTION

***When replacing the tires, recheck and tighten the wheel nuts after driving about 1,000 km (620 miles). If the steering wheel shakes or the vehicle vibrates while driving, the tire is out of balance. Align the tire balance. If the problem is not solved, we recommend that you contact an authorized HYUNDAI dealer.***

### **⚠ WARNING - Replacing tires**

- Driving on worn-out tires is very hazardous and will reduce braking effectiveness, steering accuracy, and traction.
- Your vehicle is equipped with tires designed to provide for safe ride and handling capability.

Do not use a size and type of tire and wheel that is different from the one that is originally installed on your vehicle. It can affect the safety and performance of your vehicle, which could lead to handling failure or rollover and serious injury. When replacing the tires, be sure to equip all four tires with the tire and wheel of the same size, type, tread, brand and load-carrying capacity.

(Continued)

### **(Continued)**

- The use of any other tire size or type may seriously affect ride, handling, ground clearance, stopping distance, body to tire clearance, snow tire clearance, and speedometer reliability.
- It is best to replace all four tires at the same time. If that is not possible, or necessary, then replace the two front or two rear tires as a pair. Replacing just one tire can seriously affect your vehicle's handling.
- The ABS works by comparing the speed of the wheels. Tire size can affect wheel speed. When replacing tires, all 4 tires must use the same size originally supplied with the vehicle. Using tires of a different size can cause the ABS (Anti-lock Brake System) and ESC (Electronic Stability Control) (if equipped) to work irregularly.

### ***Compact spare tire replacement (if equipped)***

A compact spare tire has a shorter tread life than a regular size tire. Replace it when you can see the tread wear indicator bars on the tire. The replacement compact spare tire should be the same size and design tire as the one provided with your new vehicle and should be mounted on the same compact spare tire wheel. The compact spare tire is not designed to be mounted on a regular size wheel, and the compact spare tire wheel is not designed for mounting a regular size tire.



## Wheel replacement

When replacing the metal wheels for any reason, make sure the new wheels are equivalent to the original factory units in diameter, rim width and offset.

### **⚠ WARNING**

**A wheel that is not the correct size may adversely affect wheel and bearing life, braking and stopping abilities, handling characteristics, ground clearance, body-to-tire clearance, snow chain clearance, speedometer and odometer calibration, headlight aim and bumper height.**

## Tire traction

Tire traction can be reduced if you drive on worn tires, tires that are improperly inflated or on slippery road surfaces. Tires should be replaced when tread wear indicators appear. To reduce the possibility of losing control, slow down whenever there is rain, snow or ice on the road.

## Tire maintenance

In addition to proper inflation, correct wheel alignment helps to decrease tire wear. If you find a tire is worn unevenly, have your dealer check the wheel alignment.

When you have new tires installed, make sure they are balanced. This will increase vehicle ride comfort and tire life. Additionally, a tire should always be rebalanced if it is removed from the wheel.

## Tire sidewall labeling

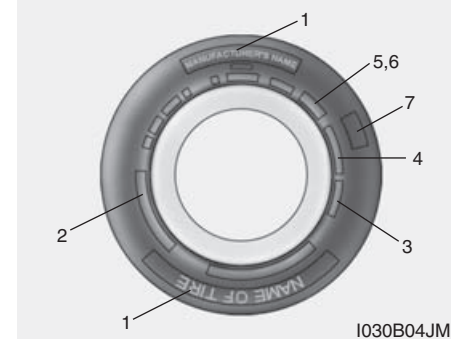

This information identifies and describes the fundamental characteristics of the tire and also provides the tire identification number (TIN) for safety standard certification. The TIN can be used to identify the tire in case of a recall.

### **1. Manufacturer or brand name**

Manufacturer or Brand name is shown.

## 2. Tire size designation

A tire's sidewall is marked with a tire size designation. You will need this information when selecting replacement tires for your car. The following explains what the letters and numbers in the tire size designation mean.

Example tire size designation:

(These numbers are provided as an example only; your tire size designator could vary depending on your vehicle.)

### (P)235/60R18 102H

P - Applicable vehicle type (tires marked with the prefix "P" are intended for use on passenger vehicles or light trucks; however, not all tires have this marking).  
(if equipped)

235 - Tire width in millimeters.

60 - Aspect ratio. The tire's section height as a percentage of its width.

R - Tire construction code (Radial).

18 - Rim diameter in inches.

102 - Load Index, a numerical code associated with the maximum load the tire can carry.

H - Speed Rating Symbol. See the speed rating chart in this section for additional information.

## Wheel size designation

Wheels are also marked with important information that you need if you ever have to replace one. The following explains what the letters and numbers in the wheel size designation mean.

Example wheel size designation:

### 7.5JX18

7.5 - Rim width in inches.

J - Rim contour designation.

18 - Rim diameter in inches.

### Tire speed ratings

The chart below lists many of the different speed ratings currently being used for passenger car tires. The speed rating is part of the tire size designation on the sidewall of the tire. This symbol corresponds to that tire's designed maximum safe operating speed.

Speed Rating Symbol	Maximum Speed
S	180 km/h (112 mph)
T	190 km/h (118 mph)
H	210 km/h (130 mph)
V	240 km/h (149 mph)
Z	Above 240 km/h (149 mph)

### 3. Checking tire life (TIN : Tire Identification Number)

Any tires that are over 6 years old, based on the manufacturing date, tire strength and performance, decline with age naturally (even unused spare tires). Therefore, the tires (including the spare tire) should be replaced by new ones. You can find the manufacturing date on the tire sidewall (possibly on the inside of the wheel), displaying the DOT Code. The DOT Code is a series of numbers on a tire consisting of numbers and English letters. The manufacturing date is designated by the last four digits (characters) of the DOT code.

**DOT : XXXX XXXX OOOO**

The front part of the DOT means a plant code number, tire size and tread pattern and the last four numbers indicate week and year manufactured.

For example:

DOT XXXX XXXX 1614 represents that the tire was produced in the 16th week of 2014.

**⚠ WARNING - Tire age**  
**Tires degrade over time, even when they are not being used. Regardless of the remaining tread, it is recommended that tires generally be replaced after six (6) years of normal service. Heat caused by hot climates or frequent high loading conditions can accelerate the aging process. Failure to follow this Warning can result in sudden tire failure, which could lead to a loss of control and an accident involving serious injury or death.**

#### 4. *Tire ply composition and material*

The number of layers or plies of rubber-coated fabric are in the tire. Tire manufacturers also must indicate the materials in the tire, which include steel, nylon, polyester, and others. The letter "R" means radial ply construction; the letter "D" means diagonal or bias ply construction; and the letter "B" means belted-bias ply construction.

#### 5. *Maximum permissible inflation pressure*

This number is the greatest amount of air pressure that should be put in the tire. Do not exceed the maximum permissible inflation pressure. Refer to the Tire and Loading Information label for recommended inflation pressure.

#### 6. *Maximum load rating*

This number indicates the maximum load in kilograms and pounds that can be carried by the tire. When replacing the tires on the vehicle, always use a tire that has the same load rating as the factory installed tire.

#### 7. *Uniform tire quality grading*

Quality grades can be found where applicable on the tire sidewall between tread shoulder and maximum section width.

For example:  
TREADWEAR 200  
TRACTION AA  
TEMPERATURE A

FarmasOS.com

#### **Tread wear**

The tread wear grade is a comparative rating based on the wear rate of the tire when tested under controlled conditions on a specified government test course. For example, a tire graded 150 would wear one-and-a-half times (1½) as well on the government course as a tire graded 100.

The relative performance of tires depends upon the actual conditions of their use, however, and may depart significantly from the norm because of variations in driving habits, service practices and differences in road characteristics and climate.

These grades are molded on the side-walls of passenger vehicle tires. The tires available as standard or optional equipment on your vehicles may vary with respect to grade.

### Traction - AA, A, B & C

The traction grades, from highest to lowest, are AA, A, B and C. Those grades represent the tires ability to stop on wet pavement as measured under controlled conditions on specified government test surfaces of asphalt and concrete. A tire marked C may have poor traction performance.

#### **WARNING**

**The traction grade assigned to this tire is based on straight-ahead braking traction tests, and does not include acceleration, cornering, hydroplaning, or peak traction characteristics.**

### Temperature -A, B & C

The temperature grades are A (the highest), B and C representing the tire's resistance to the generation of heat and its ability to dissipate heat when tested under controlled conditions on a specified indoor laboratory test wheel.

Sustained high temperature can cause the material of the tire to degenerate and reduce tire life, and excessive temperature can lead to sudden tire failure. Grades B and A represent higher levels of performance on the laboratory test wheel than the minimum required by the law.

#### **WARNING - Tire temperature**

**The temperature grade for this tire is established for a tire that is properly inflated and not overloaded. Excessive speed, underinflation, or excessive loading, either separately or in combination, can cause heat build-up and possible sudden tire failure. This can cause loss of vehicle control and serious injury or death.**

FarmaSOS.com

### Low aspect ratio tire (if equipped)

Low aspect ratio tires, whose aspect ratio is lower than 50, are provided for sporty looks.

Because the low aspect ratio tires are optimized for handling and braking, it may be more uncomfortable to ride in and there is more noise compare with normal tires.

#### CAUTION

*Because the sidewall of the low aspect ratio tire is shorter than the normal, the wheel and tire of the low aspect ratio tire is easier to be damaged. So, follow the instructions below.*

- *When driving on a rough road or off road, drive cautiously because tires and wheels may be damaged. And after driving, inspect tires and wheels.*
- *When passing over a pothole, speed bump, manhole, or curb stone, drive slowly so that the tires and wheels are not damaged.*
- *If the tire is impacted, we recommend that you inspect the tire condition or contact an authorized HYUNDAI dealer.*
- *To prevent damage to the tire, inspect the tire condition and pressure every 3,000km.*

#### CAUTION

- *It is not easy to recognize the tire damage with your own eyes. But if there is the slightest hint of tire damage, even though you cannot see the tire damage with your own eyes, have the tire checked or replaced because the tire damage may cause air leakage from the tire.*
- *If the tire is damaged by driving on a rough road, off road, pothole, manhole, or curb stone, it will not be covered by the warranty.*
- *You can find out the tire information on the tire sidewall.*

## FUSES

### ■ Blade type



Normal



Blown

### ■ Cartridge type



Normal



Blown

### ■ Multi fuse



Normal



Blown



Normal



Blown

OLM079051N

A vehicle's electrical system is protected from electrical overload damage by fuses.

This vehicle has 2 (or 3) fuse panels, one located in the driver's side panel bolster, the other in the engine compartment near the battery.

If any of your vehicle's lights, accessories, or controls do not work, check the appropriate circuit fuse. If a fuse has blown, the element inside the fuse will be melted.

If the electrical system does not work, first check the driver's side fuse panel.

Before replacing a blown fuse, disconnect the negative battery cable.

Always replace a blown fuse with one of the same rating.

If the replacement fuse blows, this indicates an electrical problem. Avoid using the system involved and immediately consult an authorized HYUNDAI dealer.

*Three kinds of fuses are used: blade type for lower amperage rating, cartridge type, and multi fuse for higher amperage ratings.*

### **⚠ WARNING - Fuse replacement**

- **Never replace a fuse with anything but another fuse of the same rating.**
- **A higher capacity fuse could cause damage and possibly a fire.**
- **Never install a wire or aluminum foil instead of the proper fuse - even as a temporary repair. It may cause extensive wiring damage and a possible fire.**

### **⚠ CAUTION**

***Do not use a screwdriver or any other metal object to remove fuses because it may cause a short circuit and damage the system.***

### **\* NOTICE**

The actual fuse/relay panel label may differ from equipped items.

### ⚠ CAUTION

- When replacing a blown fuse or relay with a new one, make sure the new fuse or relay fits tightly into the clips. The incomplete fastening fuse or relay may cause the vehicle wiring and electric systems damage and a possible fire.
- Do not remove fuses, relays and terminals fastened with bolts or nuts. The fuses, relays and terminals may be fastened incompletely, and it may cause a possible fire. If fuses, relays and terminals fastened with bolts or nuts are blown, we recommend that you consult an authorized HYUNDAI dealer.
- Do not input any other objects except fuses or relays into fuse/relay terminals such as a driver or wiring. It may cause contact failure and system malfunction.

### Inner panel fuse replacement

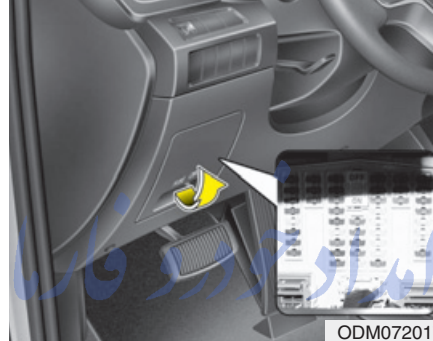

1. Turn the ignition switch and all other switches off.
2. Open the fuse panel cover.

FarmaSOS.com

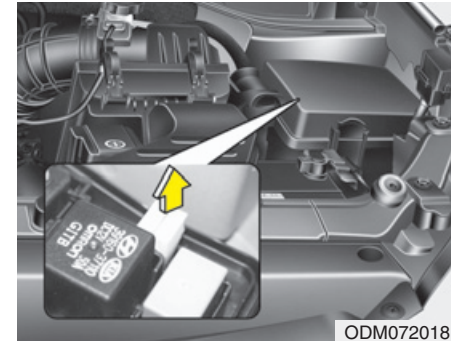

3. Pull the suspected fuse straight out. Use the removal tool provided in the engine compartment fuse panel.
4. Check the removed fuse; replace it if it is blown.
5. Push in a new fuse of the same rating, and make sure it fits tightly in the clips.

If it fits loosely, we recommend that you consult an authorized HYUNDAI dealer.

*If you do not have a spare, use a fuse of the same rating from a circuit you may not need for operating the vehicle, such as the cigar lighter fuse.*



If the headlights or other electrical components do not work and the fuses are OK, check the fuse block in the engine compartment. If a fuse is blown, it must be replaced.

### Fuse switch

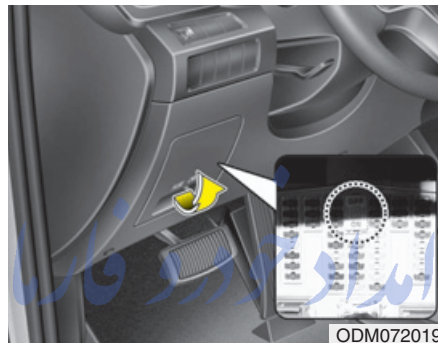

Always, put the Fuse switch at the ON position.

If you move the switch to the OFF position, some items such as audio and digital clock must be reset and transmitter (or smart key) may not work properly.

### CAUTION

***Always place the fuse switch in the ON position while driving the vehicle.***

### Engine compartment panel fuse replacement

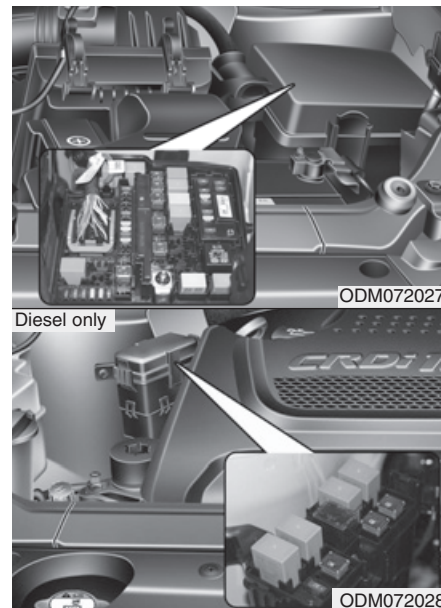

1. Turn the ignition switch and all other switches off.
2. Remove the fuse box cover by pressing the tap and pulling up.

3. Check the removed fuse; replace it if it is blown. To remove or insert the fuse, use the fuse puller in the engine compartment fuse panel.
4. Push in a new fuse of the same rating, and make sure it fits tightly in the clips. If it fits loosely, we recommend that you consult an authorized HYUNDAI dealer.

### CAUTION

***After checking the fuse box in the engine compartment, securely install the fuse box cover. If not, electrical failures may occur from water leaking in.***

### **Multi fuse**



If the multi fuse is blown, it must be removed as follows:

1. Disconnect the negative battery cable.
2. Remove the bolts shown in the picture above.
3. Replace the fuse with a new one of the same rating.
4. Reinstall in the reverse order of removal.

### **\* NOTICE**

**If the multi fuse is blown, we recommend that you consult an authorized HYUNDAI dealer.**

## Fuse/Relay panel description





Inside the fuse/relay box covers, you can find the fuse/relay label describing fuse/relay name and capacity.



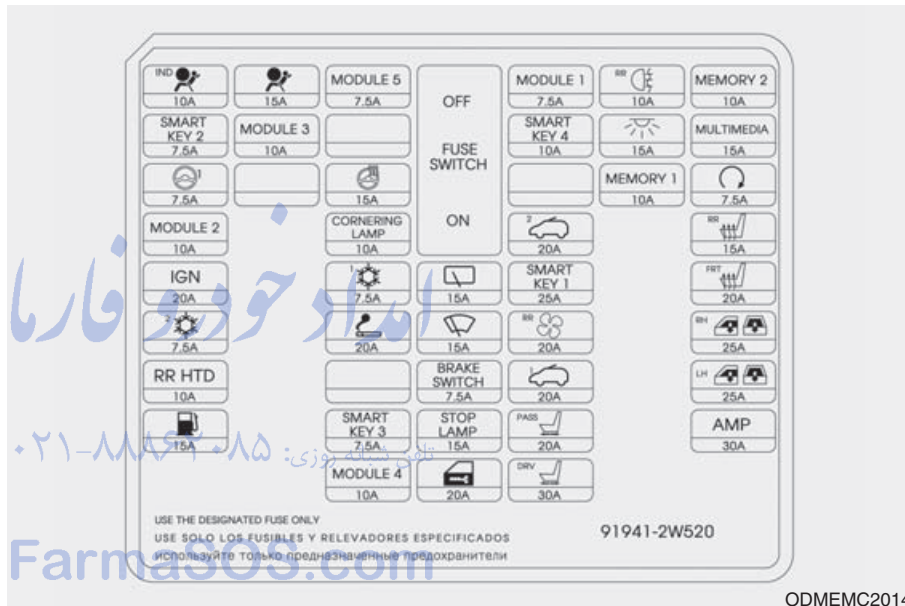







### \* NOTICE









Not all fuse panel descriptions in this manual may be applicable to your vehicle. It is accurate at the time of printing. When you inspect the fuse box on your vehicle, refer to the fuse box label.







ODMEMC2014

Description	Symbol	Fuse rating	Protected Component
A/BAG IND		10A	Instrument Cluster
A/BAG		15A	SRS Control Module, A/C Control Module
MODULE 5	MODULE 5	7.5A	Rain Sensor, Sunroof, Smart Key Control Module, BCM, Parking Guide System, AC, Inverter Module, ICM Relay Box (Cornering Lamp Relay LH/RH, Rear Blower Relay), Rear Seat Warmer LH/RH, Driver/Passenger Climate Control Seat Control Module, Driver/Passenger Seat Warmer Module
MODULE 1	MODULE 1	7.5A	Sport Mode Switch, Key Solenoid, Console Switch LH/RH, Front Console Switch, Rear Power Window Switch LH/RH
REAR FOG LAMP		10A	ICM Relay Box (Rear Fog Lamp Relay)
MEMORY 2	MEMORY 2	10A	BCM, Tire Pressure Monitoring Module, Driver IMS Module, Driver/Passenger Door Module, Auto Light & Photo Sensor, Data Link Connector, A/C Control Module, Instrument Cluster
SMART KEY 2	SMART KEY 2	7.5A	Smart Key Control Module, Immobilizer Module
MODULE 3	MODULE 3	10A	BCM, Instrument Cluster, Tire Pressure Monitoring Module, AMP, Smart Parking Assist Control Module, Electro Chromic Mirror, Lane Departure Warning Module, Steering Angle Sensor, A/C Control Module, A/V & Navigation Head Unit, 4WD ECM ATM Shift Lever Indicator, Rear Parking Assist Sensor LH/RH, Rear Seat Warmer LH/RH, Driver/Passenger Climate Control Seat Control Module, Driver/Passenger Seat Warmer Module, Driver IMS Module, Console Switch LH/RH, Rear Console Switch, Rear Parking Assist Sensor (Center) LH/RH, Driver/Passenger Door Module, Electric Parking Brake Module
SMART KEY 4	SMART KEY 4	10A	Start/Stop Button Switch, Immobilizer Module









Description	Symbol	Fuse rating	Protected Component
INTERIOR LAMP		15A	Cargo Lamp, Vanity Lamp LH/RH, Overhead Console Lamp Center Room Lamp, Personal Lamp LH/RH
MULTI MEDIA		15A	Audio, A/V & Navigation Head Unit, Digital Clock
MDPS		7.5A	MDPS Unit
HANDLE HTD		15A	Steering Wheel Switch
MEMORY 1		10A	RF Receiver, Ignition Key Ill. & Door Warning Switch
START		7.5A	W/O IMMO. & Smart Key : ICM Relay Box (Burglar Alarm Relay) With IMMO./Smart Key : ECM/PCM, Transaxle Range Switch, Smart Key Control Module, E/R Fuse & Relay Box (RLY. 2)
MODULE 2		10A	Adaptive Front Lighting Module, Crash Pad Switch, Active Hood Lift Control Module, Glow Relay Unit (DSL), Multipurpose Check Connector, Head Lamp LH/RH, Head Lamp Leveling Device Actuator LH/RH, Auto Head Lamp Leveling Device Module, Stop Lamp Switch, Fuel Filter Warning Sensor (DSL), Diesel Box (RLY. 1)(DSL)
CORNERING LAMP		10A	ICM Relay Box (Cornering Lamp Relay LH/RH)
SUNROOF 2		20A	Sunroof
S/HEATER RR		15A	Rear Seat Warmer LH/RH
IGN		20A	E/R Fuse & Relay Box (Fuse - F35, F36, F37, F38)

Description	Symbol	Fuse rating	Protected Component
A/CON 1		7.5A	E/R Fuse & Relay Box (RLY. 4/14), A/C Control Module Cluster Ionizer, Diesel Box (RLY. 3/4)
WIPER RR		15A	Rear Wiper Relay, Rear Wiper Motor, Multifunction Switch
SMART KEY 1	<b>SMART KEY 1</b>	25A	Smart Key Control Module
S/HEATER FRT		20A	Driver/Passenger Climate Control Seat Control Module Driver/Passenger Seat Warmer Module
A/CON 2		7.5A	A/C Control Module
C/LIGHTER		20A	Front Power Outlet & Cigarette Lighter, Luggage Power Outlet
WIPER FRT		15A	Multifunction Switch, E/R Fuse & Relay Box (RLY. 9/11)
RR BLOWER		20A	ICM Relay Box (Rear Blower Relay)
P/WDW RH		25A	Driver/Passenger Safety Power Window Module, Driver/Passenger Door Module, Rear Power Window Switch RH, Rear Safety Power Window Module RH
RR DEFOGGER	<b>RR HTD</b>	10A	A/C Control Module
BRAKE SWITCH	<b>BRAKE SWITCH</b>	7.5A	Smart Key Control Module, Stop Lamp Switch
SUNROOF 1		20A	Sunroof

Description	Symbol	Fuse rating	Protected Component
P/WDW LH		25A	Driver/Passenger Safety Power Window Module, Driver/Passenger Door Module, Rear Power Window Switch LH, Rear Safety Power Window Module LH
FUEL LID		15A	Fuel Filler Door Switch
SMART KEY 3	<b>SMART KEY 3</b>	7.5A	Smart Key Control Module
STOP LP	<b>STOP LP</b>	15A	Stop Signal Electronic Module
P/SEAT PASS		20A	Passenger Seat Manual Switch
AMP	<b>AMP</b>	30A	AMP
MODULE 4	<b>MODULE 4</b>	10A	Audio, A/V & Navigation Head Unit, Parking Guide System Digital Clock, BCM, Overhead Console Lamp, AMP Power Outside Mirror Switch, E/R Fuse & Relay Box (RLY. 1)
DR LOCK		20A	Door Lock/Unlock Relay, Tail Gate Relay ICM Relay Box (Dead Lock Relay)
P/SEAT DRV		30A	Driver IMS Module, Driver Seat Manual Switch Driver Lumbar Support Switch













Relay NO.	Symbol	Relay Name	Relay Type
E30	POWER OUTLET	POWER OUTLET RELAY	ISO MICRO
E31		START RELAY	ISO MICRO
E32		FRONT DEICER RELAY	ISO MICRO
E33		BLOWER RELAY	ISO MICRO
E34	<sup>LO</sup> 	WIPER (LO) RELAY	ISO MICRO
E35	<sup>LO</sup> 	COOLING FAN (LO) RELAY	ISO MICRO
E36	<b>ACC</b>	ACC RELAY	ISO MICRO
E37	<b>IG1</b>	IG1 RELAY	ISO MICRO
E38	<b>IG2</b>	IG2 RELAY	ISO MICRO
E39	<sup>HI</sup> 	COOLING FAN (HI) RELAY	ISO MINI
E40	<sup>HI</sup> 	WIPER (HI) RELAY	ISO MICRO
E41	<b>RR HTD</b>	REAR DEFOGGER RELAY	ISO MICRO
E42		HORN RELAY	ISO MICRO
E43		HEAD LAMP WASHER RELAY	ISO MICRO

	Description	Symbol	Fuse rating	Protected Component
MULTI FUSE	MDPS	 1	80A	MDPS Unit
	B+2	 B+2	60A	Smart Junction Box (IPS 1 (4CH), IPS 2 (1CH), IPS 5 (1CH), Fuse - F31/F36/F41/F45)
	BLOWER		40A	RLY. 4 (Blower Relay)
	RR HTD	<b>RR HTD</b>	40A	RLY. 12 (Rear Defogger Relay)
	ABS1	 1	40A	ABS Control Module, ESC Control Module, Multipurpose Check Connector
	ABS2	 2	40A	ABS Control Module, ESC Control Module
	C/FAN		60A	Except Europe - RLY. 6 (Cooling Fan (LO) Relay), RLY. 10 (Cooling Fan (HI) Relay)
	B+3	 B+3	60A	Smart Junction Box (Fuse - F4/F5/F10/F21/F26, Leak Current Autocut Device)
FUSE	B+4	 B+4	50A	Smart Junction Box (IPS 3 (4CH), IPS 4 (2CH), IPS 6 (2CH), Fuse - F35/F38/F40/F44)
	EMS	 7	40A	EMS Box
	C/FAN		50A	Except Europe - RLY. 6 (Cooling Fan (LO) Relay), RLY. 10 (Cooling Fan (HI) Relay)
	IG1	<b>IG1</b>	40A	Ignition Switch (W/O Smart Key), RLY. 7/8 (ACC/IG1 Relay, With Smart Key)
	IG2	<b>IG2</b>	40A	Ignition Switch (W/O Smart Key), RLY. 2 (Start Relay)/RLY. 9 (IG2 Relay)
	TRAILER		30A	Trailer Lamp & Power Outlet

	Description	Symbol	Fuse rating	Protected Component
FUSE	B+1		50A	Smart Junction Box (Fuse - F22/F27/F32/F37/F42)
	AC INVERTER		30A	AC Inverter Module
	HORN		15A	RLY. 13 (Horn Relay)
	ACTIVE HOOD LH		30A	Active Hood Lift Control Module
	ACTIVE HOOD RH		30A	Active Hood Lift Control Module
	EPB1		15A	Electric Parking Brake Module
	EPB2		15A	Electric Parking Brake Module
	DEICER		15A	RLY. 3 (Front Deicer Relay)
	H/LP WASHER		20A	RLY. 14 (Head Lamp Washer Relay)
	P/OUTLET		25A	RLY. 1 (Power Outlet Relay)
	4WD		20A	4WD ECM
	AMS		10A	Battery Sensor
TRAILER 2		15A	Trailer Lamp & Power Outlet	

	Description	Symbol	Fuse rating	Protected Component
FUSE	TRAILER 1		15A	Trailer Lamp & Power Outlet
	WIPER		10A	BCM, PCM/ECM
	WIPER FRT		25A	RLY. 5 (Wiper (LO) Relay), Front Wiper Motor
	B/UP LAMP	<b>B/UP LP</b>	10A	M/T - Back-Up Lamp Switch, A/T - Rear Combination Lamp (IN) LH/RH, Electro Chromic Mirror, Trailer Lamp & Power Outlet, Audio, A/V & Navigation Head Unit
	ABS3		7.5A	ABS Control Module, ESC Control Module
	SENSOR5		7.5A	PCM/ECM, Mass Air Flow Sensor
	TCU		15A	TCM (DSL), Transaxle Range Switch
	F/PUMP	<b>F/PUMP</b>	15A	Fuel Pump Relay
	ECU1		15A	G4KE/G4KJ/G6DF : PCM D4HA/D4HB (VGT Regular Engine Pack) : TCM (A/T)
	ECU2		10A	D4HA/D4HB : Electronic VGT Actuator
SENSOR3		10A	G4KE : Injector #1/#2/#3/#4 G6DF : PCM, Injector #1/#2/#3/#4/#5/#6, Fuel Pump Relay D4HA/D4HB (VGT Regular Engine Pack) : Lambda Sensor, Stop Lamp Switch D4HA (VGT Low Power Engine Pack) : Lambda Sensor	

	Description	Symbol	Fuse rating	Protected Component
FUSE	IGN COIL	<b>IGN COIL</b>	20A	G4KE/G4KJ : Condenser, Ignition Coil #1/#2/#3/#4 G6DF : Condenser #1/#2, Ignition Coil #1/#2/#3/#4/#5/#6 D4HA/D4HB : ECM
	SENSOR2		10A	G4KE/G4KJ : Purge Control Solenoid Valve, Camshaft Position Sensor #1/#2, Variable Intake Solenoid Valve, Crankshaft Position Sensor, Oil Control Valve #1/#2, Fuel Pump Relay G6DF : PCM, Oil Control Valve #1/#2/#3/#4, Variable Intake Solenoid Valve #1/#2, Purge Control Solenoid Valve D4HA/D4HB (VGT Regular Engine Pack) : EGR Cooling Bypass Solenoid Valve, Lower Power EGR Valve, Crankshaft Position Sensor, Fuel Pump Relay, E/R Fuse & Relay Box (RLY. 6/10) D4HA (VGT Low Power Engine Pack) : EGR Cooling Bypass Solenoid Valve, Lower Power EGR Valve, Crankshaft Position Sensor, Fuel Pump Relay, Exhaust PCV Actuator, E/R Fuse & Relay Box (RLY. 6/10)
	SENSOR1		15A	G4KE/G4KJ : Oxygen Sensor (Up/Down), Oil Level Sensor, E/R Fuse & Relay Box (RLY. 6/10) G6DF : PCM, Oxygen Sensor #1/#2/#3/#4, E/R Fuse & Relay Box (RLY. 6/10) D4HA/D4HB (VGT Regular Engine Pack) : Oil Level Sensor, Fuel Pressure Regulating Valve, Rail Pressure Regulating Valve D4HA (VGT Low Power Engine Pack) : Oil Level Sensor, Fuel Pressure Regulating Valve, Camshaft Position Sensor, Rail Pressure Regulating Valve
	SENSOR4		20A	G4KE/G4KJ : PCM
	B/ALARM		10A	Burglar Alarm Horn Relay

**Engine compartment fuse panel  
(Diesel engine only)**

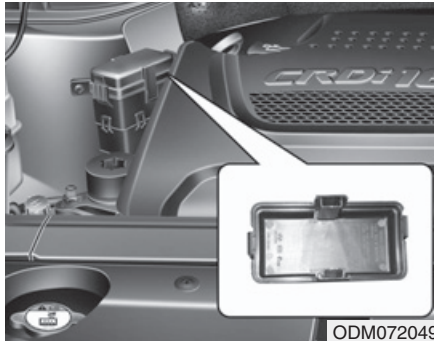



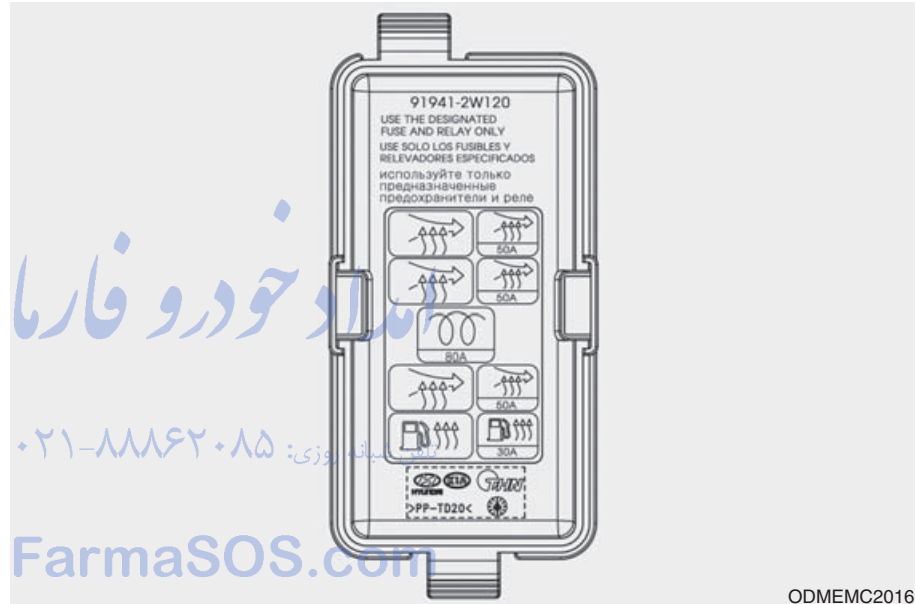

ODM072049







ODMEMC2016

**Circuit**

Symbol	Fuse rating	Protected Component
	30A	RLY. 1 (Fuel Filter Heater Relay)
	50A	RLY. 2 (PTC Heater Relay #1)
	50A	RLY. 3 (PTC Heater Relay #2)
	50A	RLY. 4 (PTC Heater Relay #3)
	80A	Glow Relay Unit

**Relay Type**

Relay NO.	Symbol	Relay Name	Relay Type
E44		RLY. 1 (Fuel Filter Heater Relay)	MICRO PLUG
E45		RLY. 2 (PTC Heater Relay #1)	MICRO PLUG
E46		RLY. 3 (PTC Heater Relay #2)	MICRO PLUG
E47		RLY. 4 (PTC Heater Relay #3)	MICRO PLUG

## LIGHT BULBS

### **WARNING** - Working on the lights

Prior to working on the light, firmly apply the parking brake, ensure that the ignition switch is turned to the “LOCK” position and turn off the lights to avoid sudden movement of the vehicle and burning your fingers or receiving an electric shock.

Use only the bulbs of the specified wattage.

### **CAUTION**

Be sure to replace the burned-out bulb with one of the same wattage rating. Otherwise, it may cause damage to the fuse or electric wiring system.

### **CAUTION**

*If you don't have necessary tools, the correct bulbs and the expertise, consult an authorized HYUNDAI dealer. In many cases, it is difficult to replace vehicle light bulbs because other parts of the vehicle must be removed before you can get to the bulb. This is especially true if you have to remove the headlight assembly to get to the bulb(s).*

*Removing/installing the headlight assembly can result in damage to the vehicle.*

### \* NOTICE

After heavy, driving rain or washing, headlight and taillight lenses could appear frosty. This condition is caused by the temperature difference between the lamp inside and outside. This is similar to the condensation on your windows inside your vehicle during the rain and doesn't indicate a problem with your vehicle. If the water leaks into the lamp bulb circuitry, we recommend that the system be checked by an authorized HYUNDAI dealer.

FarmaSOS.com



## Headlamp, position lamp, Front turn signal lamp, front fog lamp bulb replacement

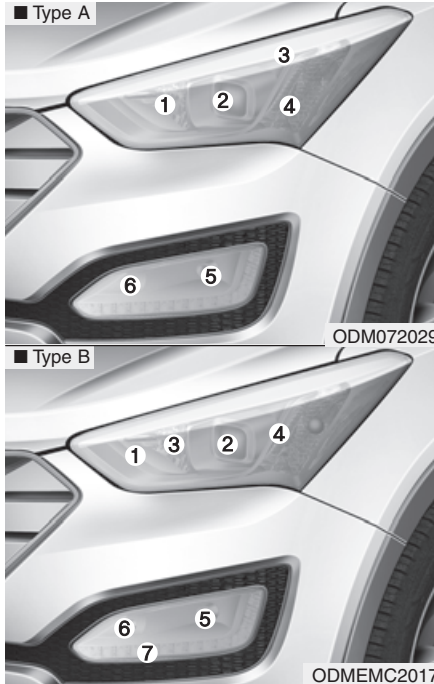

- (1) Headlamp (High)
- (2) Headlamp (Low)
- (3) Position lamp (LED/bulb)
- (4) Front turn signal lamp
- (5) Front fog lamp (if equipped)
- (6) Cornering lamp (if equipped)
- (7) Daytime running lamp (if equipped)

امداد خودرو فارما

تلفن شبانه روزی: ۰۲۱-۸۸۸۶۲۰۸۵

FarmaSOS.com

## Headlamp bulb

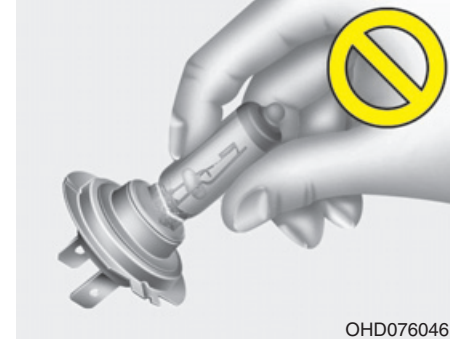

### **⚠ WARNING - Halogen bulbs**

- Halogen bulbs contain pressurized gas that will produce flying pieces of glass if broken.
- Always handle them carefully, and avoid scratches and abrasions. If the bulbs are lit, avoid contact with liquids.

(Continued)

**(Continued)**

Never touch the glass with bare hands. Residual oil may cause the bulb to overheat and burst when lit. A bulb should be operated only when installed in a headlamp.

- If a bulb becomes damaged or cracked, replace it immediately and carefully dispose of it.
- Wear eye protection when changing a bulb. Allow the bulb to cool down before handling it.

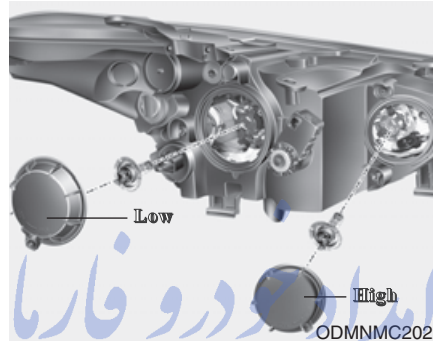

1. Open the hood.
2. Remove the headlamp bulb cover by turning it counterclockwise.
3. Disconnect the headlamp bulb socket-connector.
4. Remove the socket from the assembly by turning the socket counterclockwise until the tabs on the socket align with the slots on the assembly.
5. Remove the bulb by pulling it out.

6. Inset a new bulb into the socket.
7. Install the socket in the assembly by aligning the tabs on the socket with the slots in the assembly. Push the socket into the assembly and turn the socket clockwise.
8. Install the headlamp bulb cover by turning it clockwise.

**\* NOTICE**

We recommend that the headlight aiming be adjusted after an accident or after the headlight assembly is reinstalled at an authorized HYUNDAI dealer.

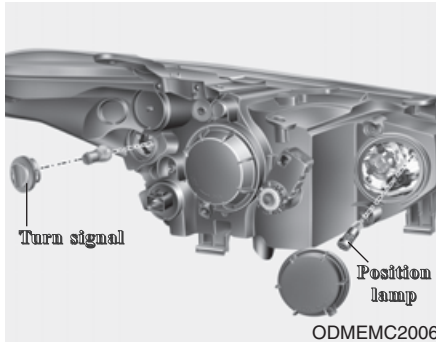

### Turn signal lamp/Position lamp

1. Remove the socket from the assembly by turning the socket counterclockwise until the tabs on the socket align with the slots on the assembly.
2. Remove the bulb from the socket by pressing it in and rotating it counterclockwise until the tabs on the bulb align with the slots in the socket. Pull the bulb out of the socket

3. Insert a new bulb into the socket and rotating it until it locks into place.
4. Install the socket in the assembly by aligning the tabs on the socket with the slots in the assembly. Push the socket into the assembly and turn the socket clockwise.

امداد خودرو فارما

تلفن شبانه روزی: ۰۲۱-۸۸۸۶۲۰۸۵

FarmaSOS.com

### Front fog lamp bulbs/cornering lamp (if equipped)

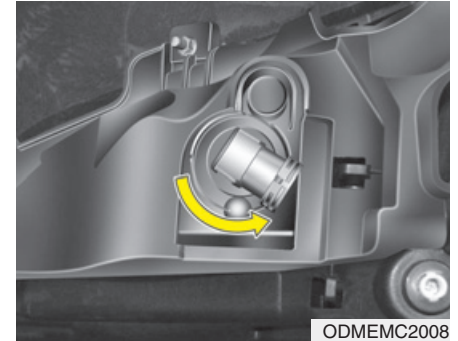

1. Remove the front bumper under cover.
2. Reach your hand into the back of the front bumper.
3. Disconnect the power connector from the socket.
4. Remove the bulb-socket from the housing by turning the socket counterclockwise until the tabs on the socket align with the slots on the housing.

5. Install the new bulb-socket into the housing by aligning the tabs on the socket with the slots in the housing. Push the socket into the housing and turn the socket clockwise.
6. Connect the power connector to the socket.
7. Reinstall the front bumper under cover.

***Headlamp (HID type), position (LED), turn signal, and front fog lamp bulb, daytime running, cornering lamp replacement***

If the light bulb does not operate, we recommend that the system be checked by an authorized HYUNDAI dealer.

**⚠ WARNING - HID  
Headlamp low beam  
(if equipped)**

**Do not attempt to replace or inspect the low beam (XENON bulb) due to electric shock danger. If the low beam (XENON bulb) is not working, we recommend that the system be checked by an authorized HYUNDAI dealer.**

**\* NOTICE**

HID lamps have superior performance vs. halogen bulbs. HID lamps are estimated by the manufacturer to last twice as long or longer than halogen bulbs depending on their frequency of use. They will probably require replacement at some point in the life of the vehicle. Cycling the headlamps on and off more than typical use will shorten HID lamps life. HID lamps do not fail in the same manner as halogen incandescent lamps. If a headlamp goes out after a period of operation but will immediately relight when the headlamp switch is cycled it is likely the HID lamp needs to be replaced. HID lighting components are more complex than conventional halogen bulbs thus have higher replacement cost.

## Headlight and front fog light aiming (for Europe)

### Headlight aiming

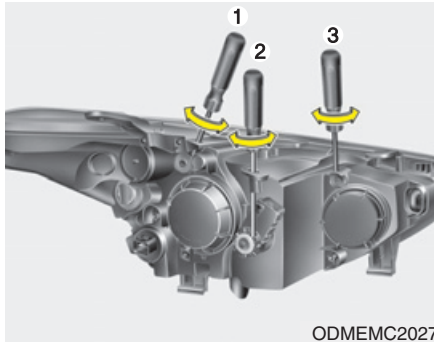

#### Without AFLS

1. Inflate the tires to the specified pressure and remove any loads from the vehicle except the driver, spare tire, and tools.
2. The vehicle should be placed on a flat floor.
3. Draw vertical lines (Vertical lines passing through respective head lamp centers) and a horizontal line (Horizontal line passing through center of head lamps) on the screen.

4. With the head lamp and battery in normal condition, aim the head lamps so the brightest portion falls on the horizontal and vertical lines.
5. To aim the low/high beam left or right, turn the driver (1) clockwise or counterclockwise. To aim the low/high beam up or down, turn the driver (2) clockwise or counterclockwise.

امداد خودروسازان

تلفن شبانه روزی: ۰۲۱-۸۸۸۶۲۰۸۵

FarmaSOS.com

#### With AFLS

1. Turn off the engine
2. Turn the light switch to the low beam position.
3. Position the tires straight ahead with the steering wheel.
4. Turn on the engine.
5. Inflate the tires to the specified pressure and remove any loads from the vehicle except the driver, spare tire, and tools.
6. The vehicle should be placed on a flat floor.
7. Draw vertical lines (Vertical lines passing through respective head lamp centers) and a horizontal line (Horizontal line passing through center of head lamps) on the screen.
8. With the head lamp and battery in normal condition, aim the head lamps so the brightest portion falls on the horizontal and vertical lines after 20 seconds for AFLS system initialization.

9. To aim the low beam left or right, turn the driver (1) clockwise or counterclockwise. To aim the low beam up or down, turn the driver (2) clockwise or counterclockwise. To aim the high beam up or down, turn the driver (3) clockwise or counterclockwise.

### *Front fog light aiming*



The front fog lamp can be aimed in the same manner as the head lamps aiming.

With the front fog lamps and battery in normal condition, aim the front fog lamps. To aim the front fog lamp up or down, turn the driver clockwise or counterclockwise.

**Aiming point**

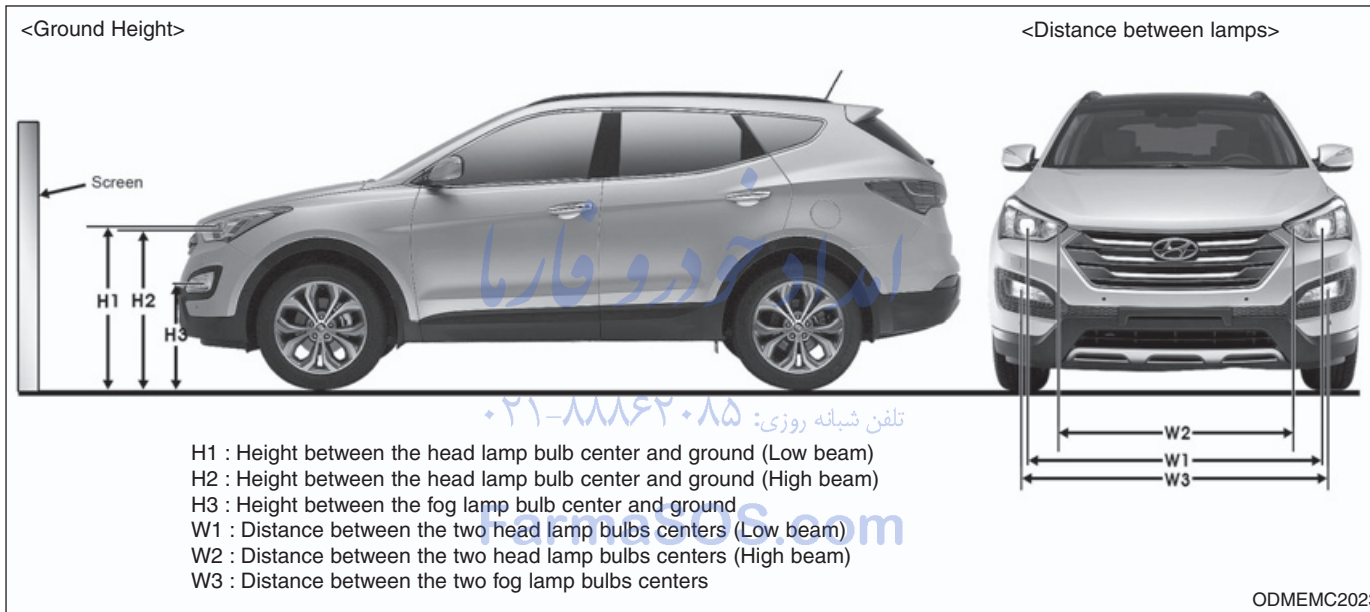

Unit: mm (in)

Vehicle condition	H1	H2	H3		W1	W2	W3	
			Fog	Fog+Cornering			Fog	Fog+Cornering
<b>Without driver</b>	888 (34.9)	868 (34.1)	591 (23.2)	594 (23.3)	1,420 (559)	1,193 (46.9)	1,433 (56.3)	1,498 (58.9)
<b>With driver</b>	886 (34.7)	863 (33.9)	586 (23.0)	591 (23.2)				

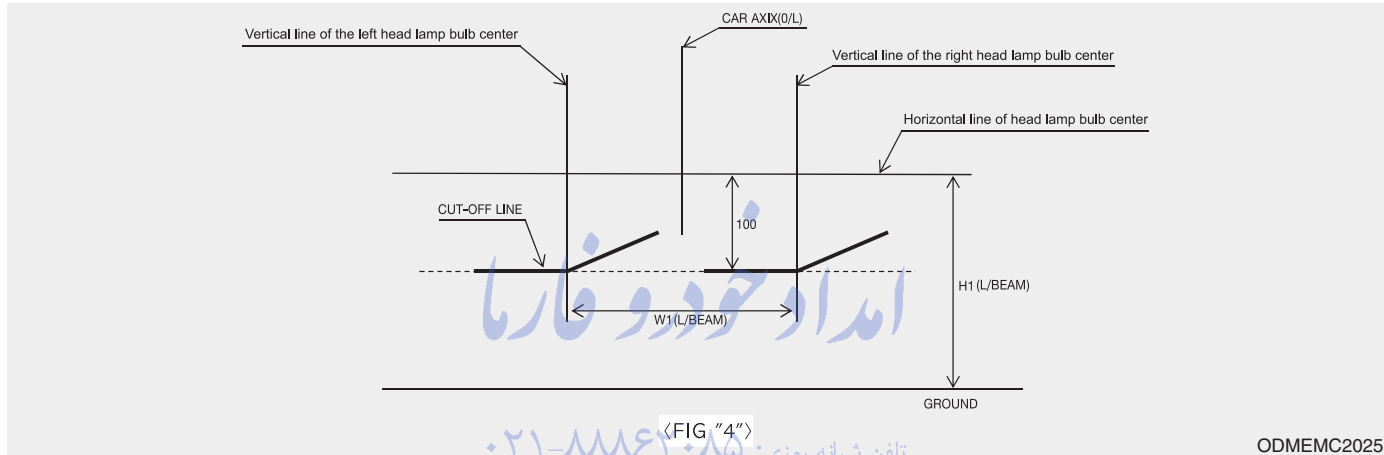

ODMEMC2025

### Head lamp low beam (LHD)

1. Turn the low beam on with the driver (75 kg) aboard.
2. The cut-off line should be projected in the cut-off line shown in the picture.
3. When aiming the low beam, vertical aiming should be adjusted after adjusting the horizontal aiming.
4. If head lamp leveling device is equipped, adjust the head lamp leveling device switch with 0 positions.



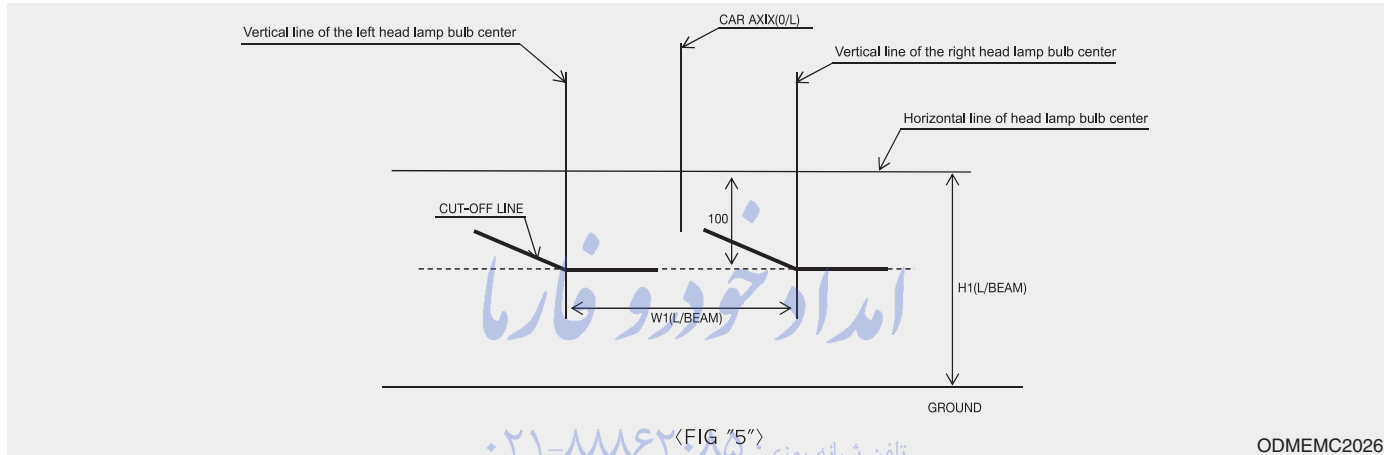

## Head lamp low beam (RHD)

1. Turn the low beam on with the driver (75 kg) aboard.
2. The cut-off line should be projected in the cut-off line shown in the picture.
3. When aiming the low beam, vertical aiming should be adjusted after adjusting the horizontal aiming.
4. If head lamp leveling device is equipped, adjust the head lamp leveling device switch with 0 positions.

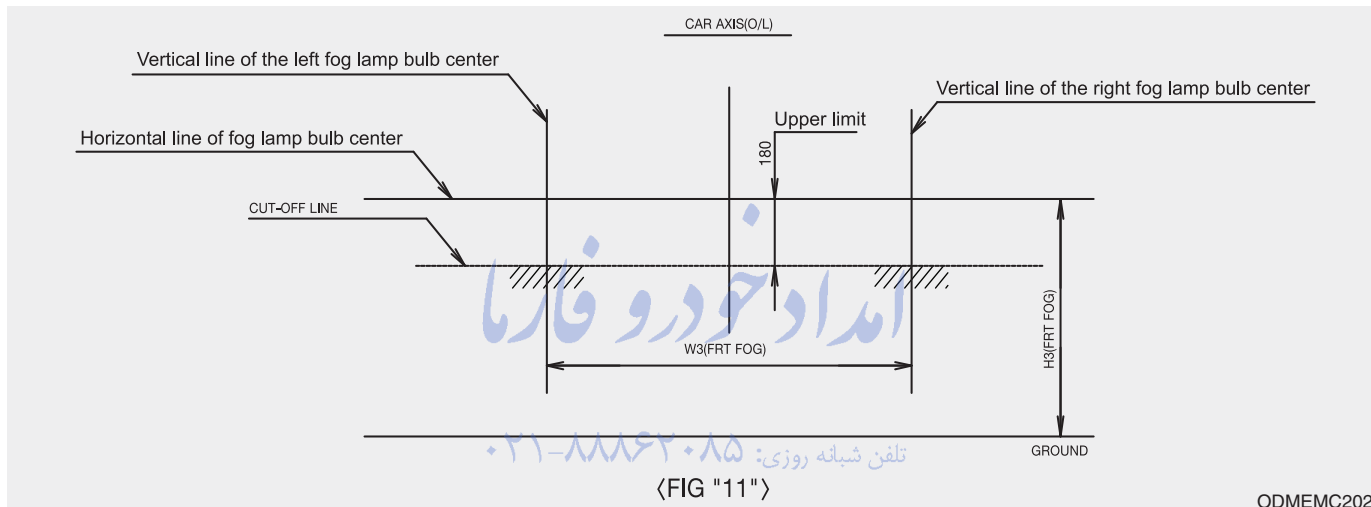

### Front fog light

1. Turn the front fog lamp on with the driver (75 kg) aboard.
2. The cut-off line should be projected in the allowable range (shaded region).

## Side repeater lamp replacement

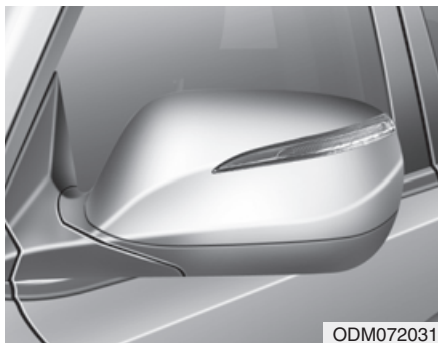

If the light bulb does not operate, we recommend that the system be checked by an authorized HYUNDAI dealer.

## Rear combination lamp bulb replacement



- (1) Stop/tail lamp
- (2) Tail lamp
- (3) Rear turn signal lamp
- (4) Back-up lamp

## Outside lamp

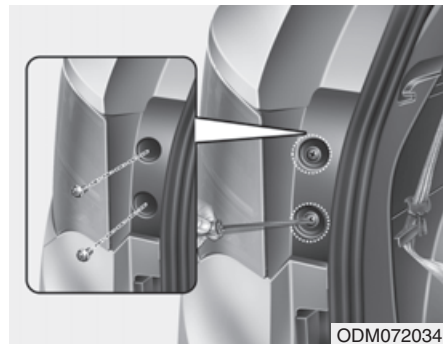

### Rear turn signal lamp and stop/tail lamp

1. Turn off the engine.
2. Open the tailgate.
3. Loosen the lamp assembly retaining screws with a cross-tip screwdriver.
4. Remove the rear combination lamp assembly from the body of the vehicle.

## ■ Type A

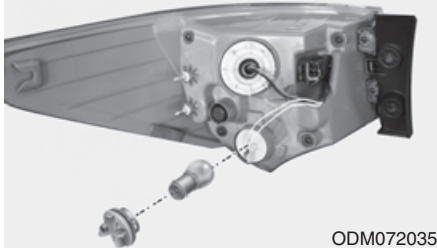

ODM072035

## ■ Type B

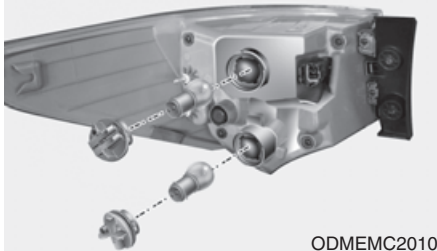

ODMEMC2010

5. Remove the socket from the assembly by turning the socket counterclockwise until the tabs on the socket align with the slots on the assembly.

6. Remove the bulb from the socket by pressing it in and rotating it counterclockwise until the tabs on the bulb align with the slots in the socket. Pull the bulb out of the socket.
7. Insert a new bulb by inserting it into the socket and rotating it until it locks into place.
8. Install the socket in the assembly by aligning the tabs on the socket with the slots in the assembly. Push the socket into the assembly and turn the socket clockwise.
9. Reinstall the lamp assembly to the body of the vehicle. *تلفن شبانه روزی: ۰۲۱-۸۸۸۸۸۸۸۸*

FarmaSOS.com

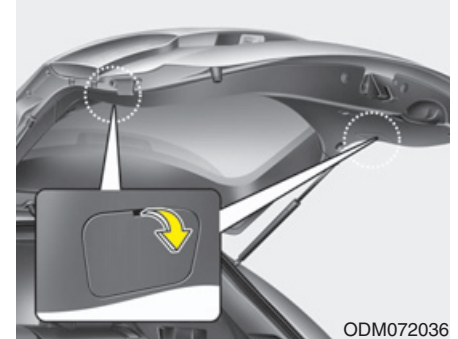
*Inside lamp*

ODM072036

1. Turn off the engine.
2. Open the tailgate.
3. Remove the service cover using a flat-blade screwdriver.

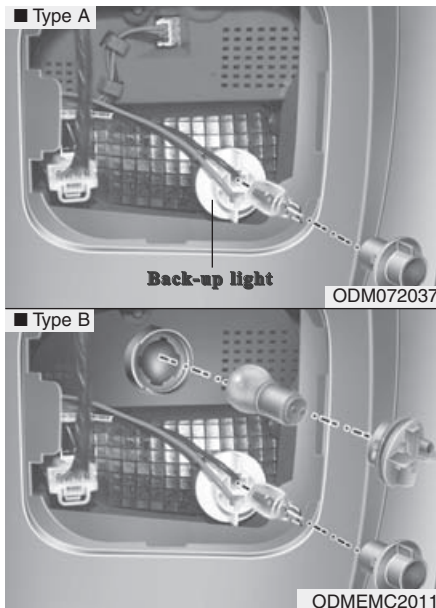

### Tail lamp/Back-up lamp (Bulb type)

4. Remove the socket from the assembly by turning the socket counterclockwise until the tabs on the socket align with the slots on the assembly.
5. Pull the bulb out of the socket.
6. Insert a new bulb into the socket.

7. Install the socket into the assembly by aligning the tabs on the socket with the slots on the assembly and turning the socket clockwise.
8. Reinstall the lamp assembly to the body of the vehicle

امداد خودرو فارما

تلفن شبانه روزی: ۰۲۱-۸۸۸۶۲۰۸۵

FarmaSOS.com

### Rear fog lamp

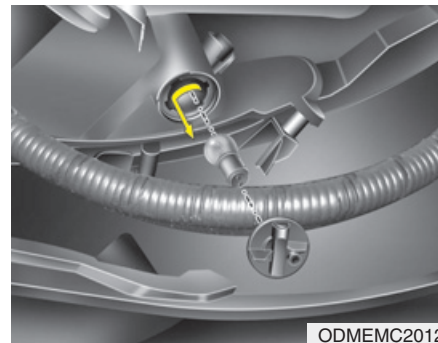

1. Remove the socket from the assembly by turning the socket counterclockwise until the tabs on the socket align with the slots on the assembly.
2. Remove the bulb from the socket by pressing it in and rotating it counterclockwise until the tabs on the bulb align with the slots in the socket. Pull the bulb out of the socket.
3. Insert a new bulb in the socket.

## High mounted stop lamp replacement

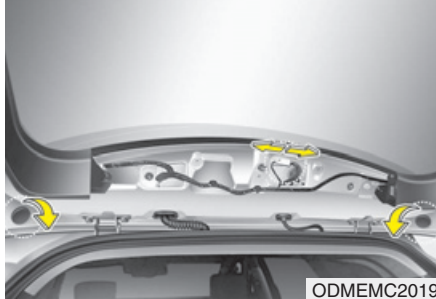
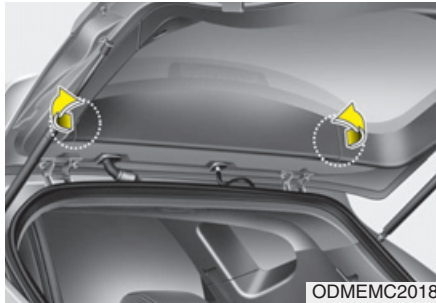

1. Open the tailgate.
2. Gently remove the center cover of the rear tailgate trim.
3. Disconnect the electrical connector.

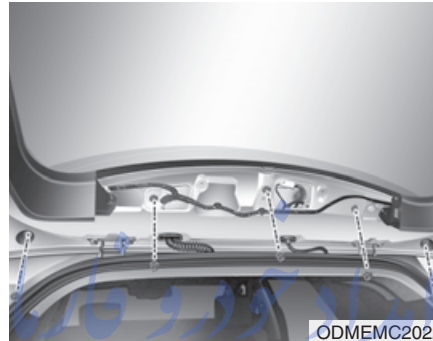

4. Loosen the retaining nuts and remove the spoiler.

تلفن شبانه روزی: ۰۲۱-۸۸۸۶۲۰۸۵

FarmaSOS.com

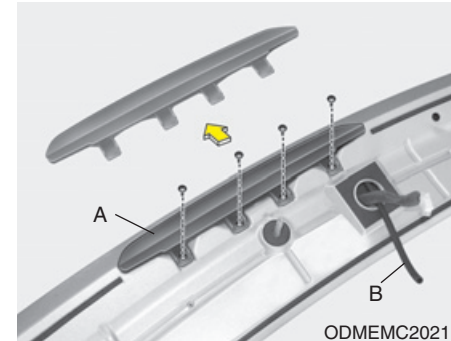

5. Remove the high mounted stop lamp assembly (A) after loosening the nuts and washer nozzle (B).
6. Reinstall a new lamp assembly in the reverse order of removal.

### License plate lamp bulb replacement

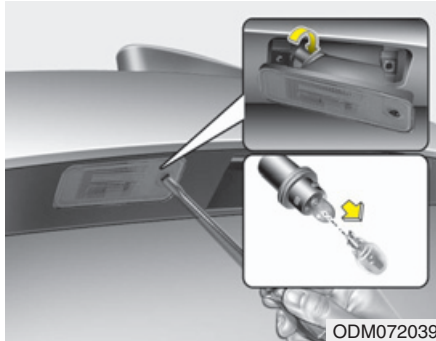

1. Loosen the lens retaining screws with a philips head screwdriver.
2. Remove the lens.
3. Remove the bulb by pulling it straight out.
4. Install a new bulb.
5. Reinstall the lens securely with the lens retaining screws.

### Door courtesy lamp bulb replacement (if equipped)

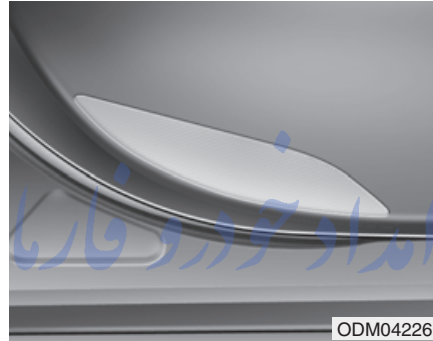

If the light bulb does not operate, we recommend that the vehicle be checked by an authorized HYUNDAI dealer.

FarmaSOS.com

#### ■ Map lamp



#### ■ Room lamp

##### ■ Type A

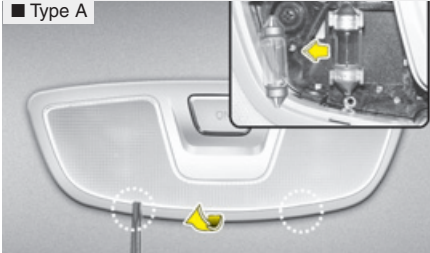

##### ■ Type B

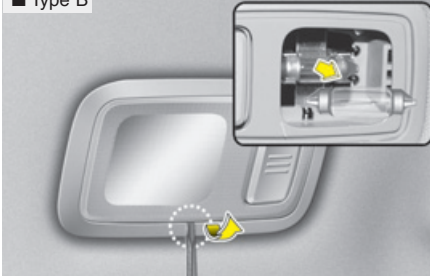

ODM072040/ODM072042/ODM072052

#### ■ Luggage room lamp (if equipped)

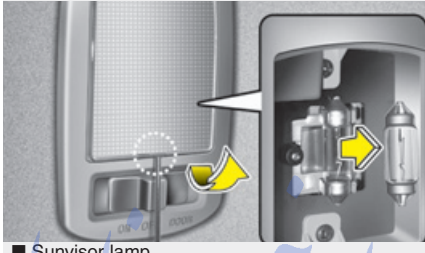

#### ■ Sunvisor lamp

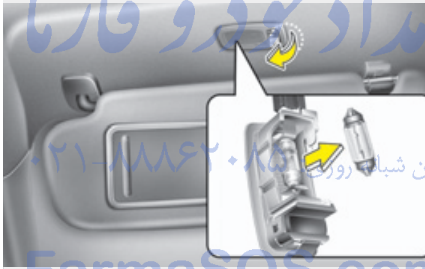

#### ■ Glove box lamp (if equipped)

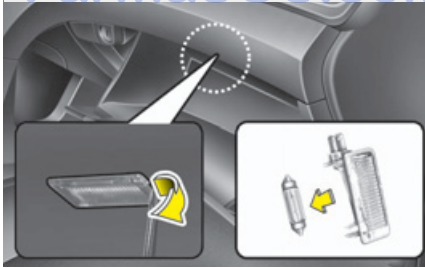

OXM079044/ODM072041/ODM072043

## Interior lamp bulb replacement

1. Using a flat-blade screwdriver, gently pry the lens from the interior lamp housing.
2. Remove the bulb by pulling it straight out.

### **⚠ WARNING**

**Prior to working on the interior lamps, ensure that the "OFF" button is depressed to avoid burning your fingers or receiving an electric shock.**

3. Install a new bulb in the socket.
4. Align the lens tabs with the interior lamp housing notches and snap the lens into place.

### **⚠ CAUTION**

**Use care not to dirty or damage lens, lens tab, and plastic housings.**



## APPEARANCE CARE

### Exterior care

#### *Exterior general caution*

It is very important to follow the label directions when using any chemical cleaner or polish. Read all warning and caution statements that appear on the label.

#### *Finish maintenance*

##### **Washing**

To help protect your vehicle's finish from rust and deterioration, wash it thoroughly and frequently at least once a month with lukewarm or cold water.

If you use your vehicle for off-road driving, you should wash it after each off-road trip. Pay special attention to the removal of any accumulation of salt, dirt, mud, and other foreign materials. Make sure the drain holes in the lower edges of the doors and rocker panels are kept clear and clean. — تلفن شبانه روزی: ۸۸۶۲۰۸۵

Insects, tar, tree sap, bird droppings, industrial pollution and similar deposits can damage your vehicle's finish if not removed immediately.

Even prompt washing with plain water may not completely remove all these deposits.

A mild soap, safe for use on painted surfaces, may be used.

After washing, rinse the vehicle thoroughly with lukewarm or cold water. Do not allow soap to dry on the finish.

#### **CAUTION**

- ***Do not use strong soap, chemical detergents or hot water, and do not wash the vehicle in direct sunlight or when the body of the vehicle is warm.***
- ***Be careful when washing the side windows of your vehicle. Especially, with high-pressure water. Water may leak through the windows and wet the interior.***
- ***To prevent damage to the plastic parts and lamps, do not clean with chemical solvents or strong detergents.***

#### **WARNING - Wet brakes**

**After washing the vehicle, test the brakes while driving slowly to see if they have been affected by water. If braking performance is impaired, dry the brakes by applying them lightly while maintaining a slow forward speed.**

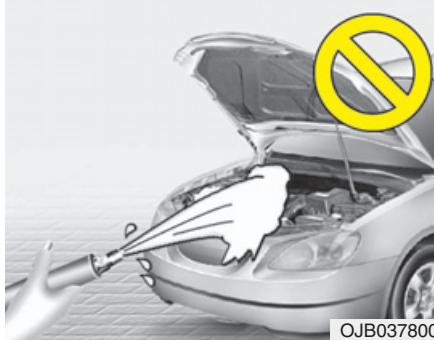

### CAUTION

- **Water washing in the engine compartment including high pressure water washing may cause the failure of electrical circuits located in the engine compartment.**
- **Never allow water or other liquids to come in contact with electrical/electronic components inside the vehicle as this may damage them.**

### Waxing

Wax the vehicle when water will no longer bead on the paint. Always wash and dry the vehicle before waxing. Use a good quality liquid or paste wax, and follow the manufacturer's instructions. Wax all metal trim to protect it and to maintain its luster. Removing oil, tar, and similar materials with a spot remover will usually strip the wax from the finish. Be sure to re-wax these areas even if the rest of the vehicle does not yet need waxing.

### CAUTION

- تلفن شبانه روزی: ۰۸۵
- **Wiping dust or dirt off the body with a dry cloth will scratch the finish.**
  - **Do not use steel wool, abrasive cleaners, or strong detergents containing highly alkaline or caustic agents on chrome-plated or anodized aluminum parts. This may result in damage to the protective coating and cause discoloration or paint deterioration.**

### Finish damage repair

Deep scratches or stone chips in the painted surface must be repaired promptly. Exposed metal will quickly rust and may develop into a major repair expense.

### \* NOTICE

**If your vehicle is damaged and requires any metal repair or replacement, be sure the body shop applies anti-corrosion materials to the parts repaired or replaced.**

### ***Bright-metal maintenance***

- To remove road tar and insects, use a tar remover, not a scraper or other sharp object.
- To protect the surfaces of bright-metal parts from corrosion, apply a coating of wax or chrome preservative and rub to a high luster.
- During winter weather or in coastal areas, cover the bright metal parts with a heavier coating of wax or preservative. If necessary, coat the parts with non-corrosive petroleum jelly or other protective compound.

### ***Underbody maintenance***

Corrosive materials used for ice and snow removal and dust control may collect on the underbody. If these materials are not removed, accelerated rusting can occur on underbody parts such as the fuel lines, frame, floor pan and exhaust system, even though they have been treated with rust protection.

Thoroughly flush the vehicle underbody and wheel openings with lukewarm or cold water once a month, after off-road driving and at the end of each winter. Pay special attention to these areas because it is difficult to see all the mud and dirt. It will do more harm than good to wet down the road grime without removing it. The lower edges of doors, rocker panels, and frame members have drain holes that should not be allowed to clog with dirt; trapped water in these areas can cause rusting.

### **⚠ WARNING**

**After washing the vehicle, test the brakes while driving slowly to see if they have been affected by water. If braking performance is impaired, dry the brakes by applying them lightly while maintaining a slow forward speed.**

### ***Aluminum or chrome wheel maintenance***

The aluminum or chrome wheels are coated with a clear protective finish.

- Do not use any abrasive cleaner, polishing compound, solvent, or wire brushes on aluminum or chrome wheels. They may scratch or damage the finish.
- Clean the wheel when it has cooled.
- Use only a mild soap or neutral detergent, and rinse thoroughly with water. Also, be sure to clean the wheels after driving on salted roads. This helps prevent corrosion.
- Avoid washing the wheels with high-speed car wash brushes.
- Do not use any alkaline or acid detergent. It may damage and corrode the aluminum or chrome wheels coated with a clear protective finish.

### ***Corrosion protection***

#### **Protecting your vehicle from corrosion**

By using the most advanced design and construction practices to combat corrosion, we produce cars of the highest quality. However, this is only part of the job. To achieve the long-term corrosion resistance your vehicle can deliver, the owner's cooperation and assistance is also required.

#### **Common causes of corrosion**

The most common causes of corrosion on your car are:

- Road salt, dirt and moisture that is allowed to accumulate underneath the car.
- Removal of paint or protective coatings by stones, gravel, abrasion or minor scrapes and dents which leave unprotected metal exposed to corrosion.

#### **High-corrosion areas**

If you live in an area where your car is regularly exposed to corrosive materials, corrosion protection is particularly important. Some of the common causes of accelerated corrosion are road salts, dust control chemicals, ocean air and industrial pollution.

### **Moisture breeds corrosion**

Moisture creates the conditions in which corrosion is most likely to occur. For example, corrosion is accelerated by high humidity, particularly when temperatures are just above freezing. In such conditions, the corrosive material is kept in contact with the car surfaces by moisture that is slow to evaporate.

Mud is particularly corrosive because it is slow to dry and holds moisture in contact with the vehicle. Although the mud appears to be dry, it can still retain the moisture and promote corrosion. High temperatures can also accelerate corrosion of parts that are not properly ventilated so the moisture can be dispersed. For all these reasons, it is particularly important to keep your car clean and free of mud or accumulations of other materials. This applies not only to the visible surfaces but particularly to the underside of the car.

### **To help prevent corrosion**

You can help prevent corrosion from getting started by observing the following:

### **Keep your car clean**

The best way to prevent corrosion is to keep your car clean and free of corrosive materials. Attention to the underside of the car is particularly important.

- If you live in a high-corrosion area — where road salts are used, near the ocean, areas with industrial pollution, acid rain, etc.—, you should take extra care to prevent corrosion. In winter, hose off the underside of your car at least once a month and be sure to clean the underside thoroughly when winter is over.
- When cleaning underneath the car, give particular attention to the components under the fenders and other areas that are hidden from view. Do a thorough job; just dampening the accumulated mud rather than washing it away will accelerate corrosion rather than prevent it. Water under high pressure and steam are particularly effective in removing accumulated mud and corrosive materials.

- When cleaning lower door panels, rocker panels and frame members, be sure that drain holes are kept open so that moisture can escape and not be trapped inside to accelerate corrosion.

### **Keep your garage dry**

Don't park your car in a damp, poorly ventilated garage. This creates a favorable environment for corrosion. This is particularly true if you wash your car in the garage or drive it into the garage when it is still wet or covered with snow, ice or mud. Even a heated garage can contribute to corrosion unless it is well ventilated so moisture is dispersed.

### Keep paint and trim in good condition

Scratches or chips in the finish should be covered with "touch-up" paint as soon as possible to reduce the possibility of corrosion. If bare metal is showing through, the attention of a qualified body and paint shop is recommended.

**Bird droppings :** Bird droppings are highly corrosive and may damage painted surfaces in just a few hours. Always remove bird droppings as soon as possible.

### Don't neglect the interior

Moisture can collect under the floor mats and carpeting to cause corrosion. Check under the mats periodically to be sure the carpeting is dry. Use particular care if you carry fertilizers, cleaning materials or chemicals in the car.

These should be carried only in proper containers and any spills or leaks should be cleaned up, flushed with clean water and thoroughly dried.

تلفن شبانه روزی: ۰۲۱-۸۸۸۶۲۰۸۵

FarmaSOS.com

### Interior care

#### *Interior general precautions*

Prevent chemicals such as perfume, cosmetic oil, sun cream, hand cleaner and air freshener from contacting the interior parts because they may cause damage or discoloration. If they do contact the interior parts, wipe them off immediately. See the instructions that follow for the proper way to clean vinyl.



#### **CAUTION**

***Never allow water or other liquids to come in contact with electrical/electronic components inside the vehicle as this may damage them.***

 **CAUTION**

***When cleaning leather products (steering wheel, seats etc.), use neutral detergents or low alcohol content solutions. If you use high alcohol content solutions or acid/alkaline detergents, the color of the leather may fade or the surface may get stripped off.***

***Cleaning the upholstery and interior trim***

**Vinyl**

Remove dust and loose dirt from vinyl with a whisk broom or vacuum cleaner. Clean vinyl surfaces with a vinyl cleaner.

**Fabric**

Remove dust and loose dirt from fabric with a whisk broom or vacuum cleaner. Clean with a mild soap solution recommended for upholstery or carpets. Remove fresh spots immediately with a fabric spot cleaner. If fresh spots do not receive immediate attention, the fabric can be stained and its color can be affected. Also, its fire-resistant properties can be reduced if the material is not properly maintained.

 **CAUTION**

***Using anything but recommended cleaners and procedures may affect the fabric's appearance and fire-resistant properties.***

***Cleaning the lap/shoulder belt webbing***

Clean the belt webbing with any mild soap solution recommended for cleaning upholstery or carpet. Follow the instructions provided with the soap. Do not bleach or re-dye the webbing because this may weaken it.

***Cleaning the interior window glass***

If the interior glass surfaces of the vehicle become fogged (that is, covered with an oily, greasy or waxy film), they should be cleaned with glass cleaner. Follow the directions on the glass cleaner container.

 **CAUTION**

***Do not scrape or scratch the inside of the rear window. This may result in damage to the rear window defroster grid.***

## EMISSION CONTROL SYSTEM

The emission control system of your vehicle is covered by a written limited warranty. Please see the warranty information contained in the Service Passport in your vehicle.

Your vehicle is equipped with an emission control system to meet all emission regulations.

There are three emission control systems which are as follows.

- (1) Crankcase emission control system
- (2) Evaporative emission control system
- (3) Exhaust emission control system

In order to assure the proper function of the emission control systems, it is recommended that you have your car inspected and maintained by an authorized HYUNDAI dealer in accordance with the maintenance schedule in this manual.

### Caution for the Inspection and Maintenance Test (With Electronic Stability Control (ESC) system)

- **To prevent the vehicle from misfiring during dynamometer testing, turn the Electronic Stability Control (ESC) system off by pressing the ESC switch.**
- **After dynamometer testing is completed, turn the ESC system back on by pressing the ESC switch again.**

### 1. Crankcase emission control system

The positive crankcase ventilation system is employed to prevent air pollution caused by blow-by gases being emitted from the crankcase. This system supplies fresh filtered air to the crankcase through the air intake hose. Inside the crankcase, the fresh air mixes with blow-by gases, which then pass through the PCV valve into the induction system.

### 2. Evaporative emission control System

The Evaporative Emission Control System is designed to prevent fuel vapors from escaping into the atmosphere.

#### *Canister*

Fuel vapors generated inside the fuel tank are absorbed and stored in the onboard canister. When the engine is running, the fuel vapors absorbed in the canister are drawn into the surge tank through the purge control solenoid valve.

#### *Purge Control Solenoid Valve (PCSV)*

The purge control solenoid valve is controlled by the Engine Control Module (ECM); when the engine coolant temperature is low during idling, the PCSV closes so that evaporated fuel is not taken into the engine. After the engine warms-up during ordinary driving, the PCSV opens to introduce evaporated fuel to the engine.



### 3. Exhaust emission control system

The Exhaust Emission Control System is a highly effective system which controls exhaust emissions while maintaining good vehicle performance.

#### *Vehicle modifications*

This vehicle should not be modified. Modification of your vehicle could affect its performance, safety or durability and may even violate governmental safety and emissions regulations.

In addition, damage or performance problems resulting from any modification may not be covered under warranty.

- If you use unauthorized electronic devices, it may cause the vehicle to operate abnormally, wire damage, battery discharge and fire. For your safety, do not use unauthorized electronic devices.

#### *Engine exhaust gas precautions (carbon monoxide)*

- Carbon monoxide can be present with other exhaust fumes. Therefore, if you smell exhaust fumes of any kind inside your vehicle, have it inspected and repaired immediately. If you ever suspect exhaust fumes are coming into your vehicle, drive it only with all the windows fully open. Have your vehicle checked and repaired immediately.

**⚠ WARNING - Exhaust**  
**Engine exhaust gases contain carbon monoxide (CO). Though colorless and odorless, it is dangerous and could be lethal if inhaled. Follow the instructions following to avoid CO poisoning.**

- Do not operate the engine in confined or closed areas (such as garages) any more than what is necessary to move the vehicle in or out of the area.
- When the vehicle is stopped in an open area for more than a short time with the engine running, adjust the ventilation system (as needed) to draw outside air into the vehicle.
- Never sit in a parked or stopped vehicle for any extended time with the engine running.
- When the engine stalls or fails to start, excessive attempts to restart the engine may cause damage to the emission control system.

### **Operating precautions for catalytic converters (if equipped)**

#### **⚠ WARNING - Fire**

- **A hot exhaust system can ignite flammable items under your vehicle. Do not park, idle, or drive the vehicle over or near flammable objects, such as dry grass, paper, leaves, etc.**
- **The exhaust system and catalytic system are very hot while the engine is running or immediately after the engine is turned off. Keep away from the exhaust system and catalytic, you may get burned.**  
**Also, do not remove the heat sink around the exhaust system, do not seal the bottom of the vehicle or do not coat the vehicle for corrosion control. It may present a fire risk under certain conditions.**

Your vehicle is equipped with a catalytic converter emission control device.

Therefore, the following precautions must be observed:

- Use only UNLEADED FUEL for gasoline engine.
- Do not operate the vehicle when there are signs of engine malfunction, such as misfire or a noticeable loss of performance.
- Do not misuse or abuse the engine. Examples of misuse are coasting with the ignition off and descending steep grades in gear with the ignition off.
- Do not operate the engine at high idle speed for extended periods (5 minutes or more).
- Do not modify or tamper with any part of the engine or emission control system. All inspections and adjustments must be made by an authorized HYUNDAI dealer.
- Avoid driving with a very low fuel level. If you run out of gasoline, it could cause the engine to misfire and result in excessive loading of the catalytic converter.

Failure to observe these precautions could result in damage to the catalytic converter and to your vehicle. Additionally, such actions could void your warranties.

### ***Diesel Particulate Filter (if equipped)***

The Diesel Particulate Filter (DPF) system removes the soot emitted from the vehicle.

Unlike a disposable air filter, the DPF system automatically burns (oxidizes) and removes the accumulated soot according to the driving condition. In other words, the active burning by engine control system and high exhaust gas temperature caused by normal/high driving condition burns and removes the accumulated soot.

However, if the vehicle continues to be driven at low speed for long time, the accumulated soot may not be automatically removed because of low exhaust gas temperature. In this particular case, the amount of soot is out of detection limit, the soot oxidation process by engine control system may not happen and the malfunction indicator light may blink.

When the malfunction indicator light blinks, it may stop blinking by driving the vehicle at more than 60km/h (37 mph) or at more than second gear with 1500 ~ 2000 engine rpm for a certain time (for about 25 minutes).

If the malfunction indicator light continues to be blinked in spite of the procedure, please visit an authorized HYUNDAI dealer and then check the DPF system.

If you continue to drive with the malfunction indicator light blinking for a long time, the DPF system can be damaged and fuel consumption can be worsen.



### **CAUTION - Diesel Fuel (if equipped with DPF)**

***It is recommended to use the regulated automotive diesel fuel for diesel vehicle equipped with the DPF system.***

***If you use diesel fuel including high sulfur (more than 50 ppm sulfur) and unspecified additives, it can cause the DPF system to be damaged and white smoke can be emitted.***

FarmaSOS.com

## Specifications & Consumer information

Dimensions .....	8-2
Engine .....	8-2
Bulb wattage .....	8-3
Tires and wheels .....	8-4
Gross vehicle weight .....	8-5
Luggage volume .....	8-5
Recommended lubricants and capacities .....	8-6
Vehicle identification number (VIN) .....	8-9
Vehicle certification label .....	8-9
Tire specification and pressure label .....	8-10
Engine number .....	8-10
E-mark label .....	8-11
Air conditioner compressor label .....	8-11
Refrigerant label .....	8-11
Declaration of conformity .....	8-12

FarmaSOS.com

## DIMENSIONS

item	mm(in)	
Overall length	4,690 (184.64)	
Overall width	1,880 (74.01)	
Overall height	1,680 (66.14) / 1,690 (66.53) *1	
Front tread	235/65 R17	1,633 (64.29)
	235/60 R18	1,628 (64.09)
	235/55 R19	1,628 (64.09)
Rear tread	235/65 R17	1,644 (67.72)
	235/60 R18	1,639 (64.52)
	235/55 R19	1,639 (64.52)
Wheelbase	2,700 (106.29)	

\*1 with roof rack

## ENGINE



Item		Gasoline theta II 2.4	Gasoline lambda II 3.3	Diesel R2.0	Diesel R2.2
Displacement cc (cu. in)		2,359 (143.95)	3,342 (203.94)	1,995 (121.74)	2,199 (134.19)
Bore x Stroke mm (in.)		88x97 (3.46X3.81)	92x83.8 (3.62X3.29)	84x90 (3.30X3.54)	85.4x96 (3.34X3.77)
Firing order		1-3-4-2	1-2-3-4-5-6	1-3-4-2	1-3-4-2
No. of cylinders		4. In-line	V - type	4. In-line	4. In-line

**BULB WATTAGE**

	<b>Light Bulb</b>	<b>Wattage</b>	<b>Bulb type</b>
Front	Headlights(Low)	55 or 35(HID) *	H7L or D3S
	Headlights(High)	55	H7L
	Front turn signal lamps	21	PY21W
	Front position lights	5 or LED	W5W or LED
	Front fog lights *	35	H8
	Side Repeater lamps (Outside Mirror)	LED	LED
	Cornering lights *	27	GE880
	Daytime running lights *	LED	LED
Rear	Rear fog lights *	21	P21W
	Rear Stop/Tail lights (outside)	21 or 5, LED	P21 or W5W, LED
	Rear tail lights (Inside)	8	W8W
	Rear Stop/Tail lights (Inside)	LED	LED
	Rear turn signal lights	21	PY21W
	Back-up lights	16	W16W
	High mounted stop light	LED	LED
	License plate lights	5	W5W
Interior	Map lamps	10	FESTOON
	Room lamps	8	FESTOON
	Vanity mirror lamps	5	FESTOON
	Glove box lamp	5	FESTOON
	Door courtesy lamps	5	FESTOON
	Luggage lamp	5	FESTOON

\* If equipped

## TIRES AND WHEELS

Item	Tire size	Wheel size	Inflation pressure bar (psi, kPa)				Wheel lug nut torque kg•m (lb•ft, N•m)
			Normal load (  + $\emptyset$ )		Maximum load (  +  )		
			Front	Rear	Front	Rear	
Full size tire	235/65R17	7.0J×17	2.3 (33,230)	2.3 (33,230)	2.3 (33,230)	2.3 (33,230)	9~11 (65~79, 88~107)
	235/60R18	7.5J×18					
	235/55R19	7.5J×19					
Compact spare tire (if equipped)	T165/90R17	4.0T×17	4.2 (60,420)	4.2 (60,420)	4.2 (60,420)	4.2 (60,420)	

 **CAUTION**

*When replacing tires, use the same size originally supplied with the vehicle.*

*Using tires of a different size can damage the related parts or make it work irregularly.*

FarmaSOS.com

## GROSS VEHICLE WEIGHT

### For GENERAL, MIDDLE EAST

Item	Theta II 2.4	Lambda II 3.3	R2.2	
	2WD/4WD	4WD	2WD	4WD
5 Seater	2,510 kg (5,533 lbs.)	2,510 kg (5,533 lbs.)	2,510 kg (5,533 lbs.)	2,510 kg (5,533 lbs.)
7 Seater	2,510 kg (5,533 lbs.)	2,510 kg (5,533 lbs.)	2,510 kg (5,533 lbs.)	2,550 kg (5,622 lbs.)

### For EUROPE

Item	Theta II 2.4	R2.0		R2.2	
	2WD/4WD	2WD	4WD	2WD	4WD
5 Seater	2,510 kg (5,533 lbs.)	2,510 kg (5,533 lbs.)	2,510 kg (5,533 lbs.)	2,510 kg (5,533 lbs.)	2,510 kg (5,533 lbs.)
7 Seater	2,510 kg (5,533 lbs.)	2,550 kg (5,622 lbs.)	2,600 kg (5,732 lbs.)	2,550 kg (5,622 lbs.)	2,600 kg (5,732 lbs.)

### For AUSTRALIA

Item	Theta II 2.4	Lambda II 3.3	R2.2
	4WD	2WD	4WD
5 Seater	2,510 kg (5,533 lbs.)	2,510 kg (5,533 lbs.)	2,510 kg (5,533 lbs.)
7 Seater	2,510 kg (5,533 lbs.)	2,510 kg (5,533 lbs.)	2,600 kg (5,732 lbs.)

FarmaSOS.com

## LUGGAGE VOLUME

Item		5 Seater	7 Seater
VDA	MIN.	585 l (20.7 cu ft)	516 l (18.2 cu ft)
	MAX.	1,680 l (59.3 cu ft)	1,615 l (57.0 cu ft)

Min : Behind rear seat to upper edge of the seat back.

Max : Behind front seat to roof.



## RECOMMENDED LUBRICANTS AND CAPACITIES

To help achieve proper engine and powertrain performance and durability, use only lubricants of the proper quality. The correct lubricants also help promote engine efficiency that results in improved fuel economy.

These lubricants and fluids are recommended for use in your vehicle.

Lubricant			Volume	Classification
Engine oil *1 *2 (drain and refill)  Recommends  	Gasoline Engine	Theta II 2.4 (For Europe)	4.8 l (5.07 US qt.)	API Service SM *5, ILSAC GF-4 or above ACEA A5 (or above)
		Theta II 2.4 (Except Europe)	4.6 l (4.86 US qt.) *3 5.0 l (5.28 US qt.) *4	
		3.3L	5.7 l (6.02 US qt.)	
	Diesel Engine	with DPF *6	6.3 l (6.66 US qt.)	ACEA C2 (C3)
without DPF *6		ACEA B4		
Engine oil consumption	Normal driving condition		MAX. 1L / 1,500 km	-
	Severe driving condition		MAX. 1L / 1,000 km	-
Manual transaxle fluid			1.8 ~ 1.9 l (1.90 ~ 2.00 US qt.)	API GL-4, SAE 75W/85
Automatic transaxle fluid	Gasoline Engine	2.4L	7.1 l (7.50 US qt.)	MICHANG ATF SP-IV, SK ATF SP-IV, NOCA ATF SP-IV, HYUNDAI genuine ATF SP-IV
		3.3L	7.8 l (8.24 US qt.)	
	Diesel Engine	R2.0	7.8 l (8.24 US qt.)	
		R2.2	7.7 l (8.13 US qt.)	
Power steering fluid			1.0 l (1.06 US qt.)	PSF-4
Coolant	Gasoline Engine	2.4L	7.1 ~ 7.4 l (7.50 ~ 7.51 US qt.)	Mixture of antifreeze and distilled water (Ethylene glycol base coolant for aluminum radiator)
		3.3L	9.1 l (9.61 US qt.)	
	Diesel Engine	R2.0 / R2.2	9.1 ~ 9.3 l (9.61 ~ 9.82 US qt.)	

Lubricant		Volume	Classification
Brake/clutch fluid		0.7~0.8 l (0.74~0.85 US qt.)	FMVSS116 DOT-3 or DOT-4
Rear differential oil (4WD)		0.53 l (0.56 US qt.)	HYPOID GEAR OIL API GL-5, SAE 75W/90 (SHELL SPIRAX X or equivalent)
Transfer case oil (4WD)	2.4L R 2.0 / 2.2L	0.6 l (0.63US qt.)	HYPOID GEAR OIL API GL-5, SAE 75W/90 (SHELL SPIRAX X or equivalent)
	3.3L	0.68 l (0.72 US qt.)	
Fuel		64 l ( 16.90 US gal.)	Refer to "Fuel requirements" in section 1

<sup>\*1</sup> Refer to the recommended SAE viscosity numbers on the next page.

<sup>\*2</sup> Engine oils labeled Energy Conserving Oil are now available. Along with other additional benefits, they contribute to fuel economy by reducing the amount of fuel necessary to overcome engine friction. Often, these improvements are difficult to measure in everyday driving, but in a year's time, they can offer significant cost and energy savings.

<sup>\*3</sup> Yellow engine oil dipstick (if equipped)

<sup>\*4</sup> Red engine oil dipstick (if equipped)

<sup>\*5</sup> If the API service SM or ACEA A5 engine oil is not available in your country, you are able to use API service SL or ACEA A3.

<sup>\*6</sup> Diesel Particulate Filter

## Available Engine oil (For Europe) [FarmaSOS.com](http://FarmaSOS.com)

Supplier	Product	
	Gasoline Engine	Diesel Engine
Shell	HELIX ULTRA AH-E 5W-30	HELIX ULTRA AP 5W-30
	HELIX ULTRA 5W-40	
SK	ZIC LD5W-30	ZIC LS 5W-30
Chevron	KIXX G1 LL	KIXX D1 5W-30
Total	QUARTZ HKS G-310	QUARTZ INEO MC3 5W-30
	QUARTZ INEO MC3 5W-30	
Fuchs	TITAN SUPERSYN LONG LIFE 5W-30/40	

### Recommended SAE viscosity number

#### CAUTION

*Always be sure to clean the area around any filler plug, drain plug, or dipstick before checking or draining any lubricant. This is especially important in dusty or sandy areas and when the vehicle is used on unpaved roads. Cleaning the plug and dipstick areas will prevent dirt and grit from entering the engine and other mechanisms that could be damaged.*

Engine oil viscosity (thickness) has an effect on fuel economy and cold weather operating (engine start and engine oil flowability). Lower viscosity engine oils can provide better fuel economy and cold weather performance, however, higher viscosity engine oils are required for satisfactory lubrication in hot weather. Using oils of any viscosity other than those recommended could result in engine damage.

When choosing an oil, consider the range of temperature your vehicle will be operated in before the next oil change.

Proceed to select the recommended oil viscosity from the chart.

		Temperature Range for SAE Viscosity Numbers									
Temperature	°C	-30	-20	-10	0	10	20	30	40	50	
	(°F)	-10	0	20	40	60	80	100	120		
Gasoline Engine Oil *1 (3.3L)											20W-50
											15W-40
											10W-30
											5W-20 *2, 5W-30
Gasoline Engine Oil (2.4L MPI)											20W-50
											15W-40
											10W-30
											5W-30 (5W-40)
Gasoline Engine Oil (2.4L GDI)											5W-30 (0W-40, 5W-40)
Diesel Engine Oil											15W-40
											10W-30/40
											5W-30/40
											0W-30/40

\*1 : For better fuel economy, it is recommended to use the engine oil of a viscosity grade SAE 5W-20\*2 (API SM / ILSAC GF-4/ACEA A5). However, if the engine oil is not available in your country, select the proper engine oil using the engine oil viscosity chart.

\*2 : In Middle East, do not use the engine oil of viscosity grade SAE 5W-20.

## VEHICLE IDENTIFICATION NUMBER (VIN)

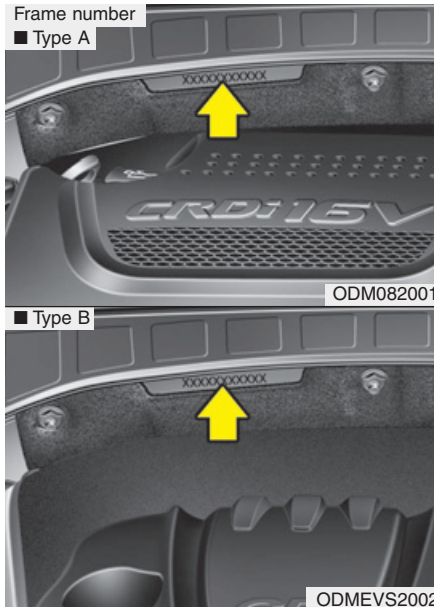

The vehicle identification number (VIN) is the number used in registering your vehicle and in all legal matters pertaining to its ownership, etc. The number is punched on the engine compartment bulkhead.

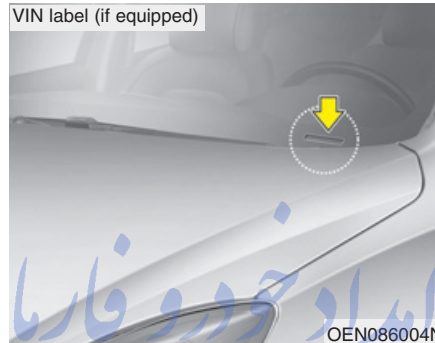

The VIN is also on a plate attached to the top of the dashboard. The number on the plate can easily be seen through the windshield from outside.

FarmaSOS.com

## VEHICLE CERTIFICATION LABEL



The vehicle certification label attached on the driver's (or front passenger's) side center pillar gives the vehicle identification number (VIN).

## TIRE SPECIFICATION AND PRESSURE LABEL

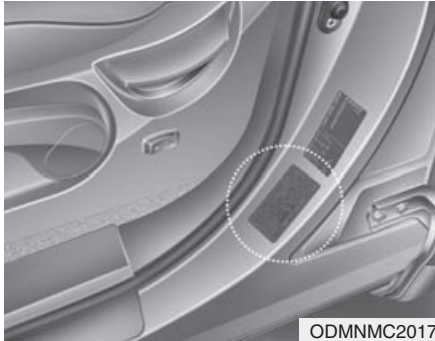

The tires supplied on your new vehicle are chosen to provide the best performance for normal driving.

The tire label located on the driver's side center pillar gives the tire pressures recommended for your vehicle.

## ENGINE NUMBER

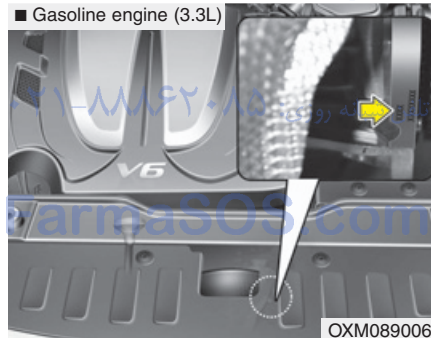
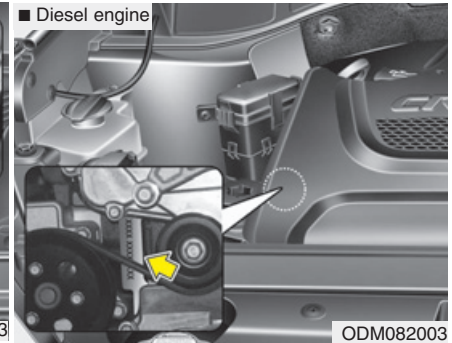
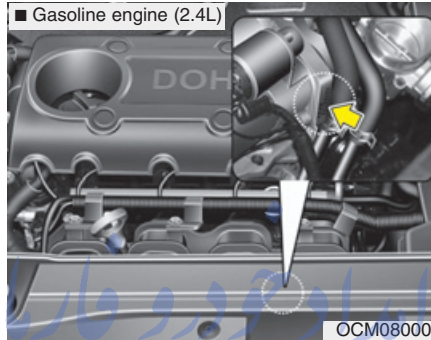

The engine number is stamped on the engine block as shown in the drawing.

## E-MARK LABEL (IF EQUIPPED)

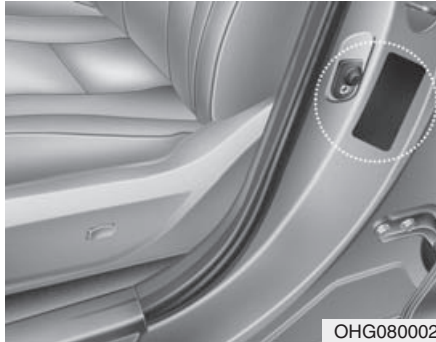

An E-mark label is located on the driver's side center pillar. The label certifies that your vehicle has satisfied the ECE Safety/Environment regulation. It contains the following information:

- Country code
- Regulation number
- Regulation amendment number
- Approval number

## AIR CONDITIONER COMPRESSOR LABEL

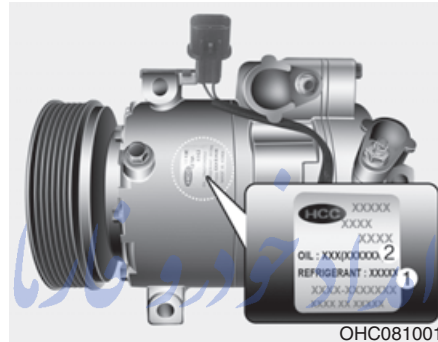

A compressor label informs you the type of compressor your vehicle is equipped with such as model, supplier part number, production number, refrigerant (1) and refrigerant oil (2).

[FarmaSOS.com](http://FarmaSOS.com)

## REFRIGERANT LABEL

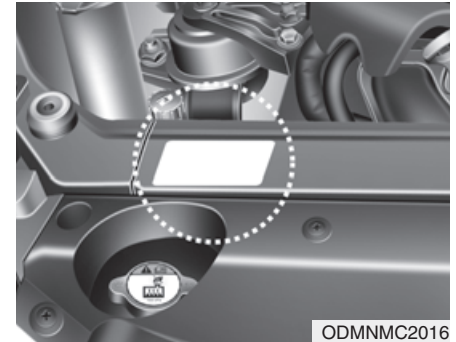

The refrigerant label is located at the front of the engine room.

## DECLARATION OF CONFORMITY (IF EQUIPPED)

■ Example

CE CE 0678

CE0678

The radio frequency components of the vehicle comply with requirements and other relevant provisions of Directive 1995/5/EC.

Further information including the manufacturer's declaration of conformity is available on HYUNDAI web site as follows;

<http://service.hyundai-motor.com>

امداد خودرو فارما

تلفن شبانه روزی: ۰۲۱-۸۸۸۶۲۰۸۵

[FarmaSOS.com](http://FarmaSOS.com)